

# PARAMETRIC CORRELATION BETWEEN DIFFERENT PARAMETERS OF A STRAIGHT SUBSOILER

## ABSTRACT

Agricultural subsoilers are used to break the hardpans below the level of the tillage depth. Weight reduction without compromising safety is one of the primary design objectives of the subsoiler. The thickness, length of curve, and width of shank are all critical parameters in designing a straight subsoiler. Identifying the significance of geometrical parameters maximizes structural safety and minimizes weight. An analysis of the parametric correlation between the output and input parameters of a straight subsoiler is presented in this paper. Parameter correlation was conducted to detect the degree to which the output parameters are influenced by the input parameters and the sensitivity of the input parameters to the output parameters. Analysis was performed using the Parameter Correlation tool of ANSYS Workbench. Results indicated that the thickness of the shank and width of the shank influenced the output parameters significantly, whereas the length of the curve of the inclined subsoiler had no significant influence on the output parameters. The thickness of shank has the highest relevance with the straight subsoiler mass having a correlation value of 0.78919 and R2 contribution of 0.60063. The width of shank has the highest relevance with total deformation with a correlation value of -0.77197 and an R2 contribution of 0.59353. Increasing thickness and width of shank of the subsoiler leads to an increasing trend in the subsoiler mass, safety factor, and volume. Increasing thickness and width of shank lead to decreasing trends in total deformation, equivalent stress, and maximum principal stress. Changes in length of curve of the straight subsoiler did not lead to any trend in the output parameters. Thus, thickness and width of shank were designated as the major input parameters while length of curve was designated as the minor input parameter.

**Keywords:** *Parameters correlation, correlation analysis, SolidWorks, ANSYS, Finite element modelling, straight subsoiler*

## 1. INTRODUCTION

Agricultural operations such as tilling and ploughing that continue for an extended period can severely degrade the soil structure, leading to a dense plough pan. It negatively affects the development of root systems in crops and thus their ability to absorb water and nutrients, hindering sustainable crop production [1]. Soil deep tillage, such as subsoiling, enhances the soil's physical properties, particularly the soil porosity and distribution, which affects the soil moisture, nutrients, porosity, and temperature, increasing crop productivity [2,3]. A subsoiler usually carries subsoiling to disrupt hardpans and provide pathways for water and roots to enter the soil [4,5].

Subsoilers are implements installed on tractors that break up and loosen the soil beneath the level of normal ploughing [6]. Subsoilers encounter massive resistance from the soil throughout their operation since they work deeper than typical tillage tools [7]. It is essential that the subsoiler structure can withstand these forces. Otherwise, it will deform and break during operation [8]. For structural integrity and weight reduction, subsoilers must be designed correctly. There are two main approaches to analyzing subsoiler designs: theoretical and numerical approaches [9]. Some engineering problems can be solved using theoretical methods, but some problems are too complex or too large to deal with. As a result, engineers use numerical methods to calculate approximate solutions to large-scale and complicated problems [10].

Finite Element Method (FEM) is a numerical technique that is widely used in the field of engineering design as well as manufacturing. FEM is a mathematical procedure that can be used to solve a large class of engineering problems in stress analysis, heat transfer, electromagnetism, and fluid flow. Correctly modelled finite element analysis (FEA) is more reliable, but it requires a lot of computational power [11].

Subsoilers require several parametric FEA analyses to achieve the optimal design point during the design process. In the optimization process, one of the primary goals is to determine how the various design parameters of the tillage tool impact the various forces acting on the tool. It is imperative to carry out a parametric analysis study focusing on the different subsoiler parameters. ANSYS Workbench software offers a toolbox named as DesignXplorer. DesignXplorer offers a parameter correlation tool, which analyzes the relationship between pre-defined parameters.

A parameter correlation study is based on a deterministic model [12]. Unlike probabilistic models, deterministic models do not allow for randomness, and one always gets the same output for a specific input. The quantity and quality of input data will affect the accuracy of the parameters correlation study [13]. In a parametric study, all the input parameters have a differential effect on the output parameters.

In the present article, the study of parameter correlation focuses exclusively on geometric variables. This study performed a parametric analysis to determine how input parameters affect the output and evaluate their sensitivity to the output parameters. Parameters correlation tool is used to discover parameter sensitivities. Each input parameter is evaluated according to its effect on the output [9]. Visual and numerical representations are also provided.

## 2. MATERIALS AND METHODS

Measurements were taken on the experimental subsoiler. The subsoiler was modelled in 3D with SolidWorks software using these measurements. An FEA model was created by transferring the model from SolidWorks to the ANSYS DesignModeler toolbox. ANSYS static structural analysis system was used to calculate the subsoiler's output parameters under static loading conditions. The input and output parameters of the model were generated from the structural analysis. Responses were modeled under steady loading conditions.

The input parameters included thickness of shank (P1), length of curve (P2), and width of shank (P3), having values of 25 mm, 120 mm, and 80 mm, respectively (Fig. 1). Output parameters included straight subsoiler mass (P4), total deformation (P5), equivalent stress (P6), maximum principal stress (P7), safety factor (P8), and straight subsoiler volume (P9). The input and output parameters were exported to a parameters set.

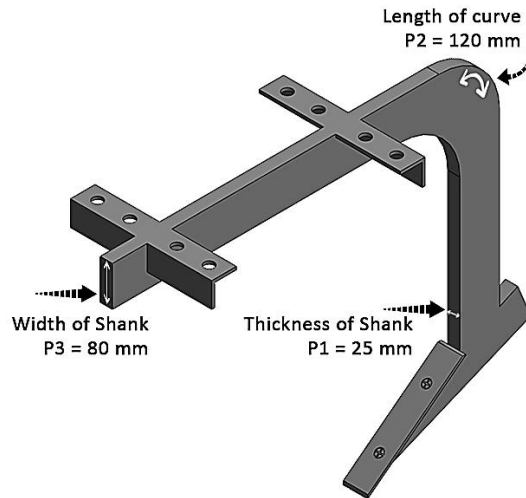

**Fig. 1. Design parameters of Inclined subsoiler**

After the parameter set was generated, a correlation analysis was performed. Correlation, or correlation analysis, determines the association between two (or more) quantitative variables [14]. This analysis was performed using ANSYS “Parameters Correlation” function. The result of correlation analysis is the correlation coefficient. ANSYS supports a wide range of options, such as choosing the type of correlation, the number of samples for parameter correlation, and the size of samples for correlation statistics.

The model geometry was used to generate 100 data points by varying P1, P2 and P3, specified separately by specifying the upper and lower bounds. Pearson’s correlation coefficient was calculated between the input and output parameters with a sample set size of 40. The lower and upper bounds assigned for the input parameters for parametric correlation are:

$$\begin{array}{l}
 20 \text{ mm} \leq \text{Thickness of shank (P1)} \leq 25 \text{ mm} \\
 110 \text{ mm} \leq \text{Length of curve (P2)} \leq 130 \text{ mm} \\
 70 \text{ mm} \leq \text{Width of shank (P3)} \leq 90 \text{ mm}
 \end{array}$$

In addition to the correlation analysis, sensitivity analysis was also conducted for each input parameter with the output parameters. In numerical models, sensitivity analysis determines whether the uncertainties in one or more input variables may lead to uncertainties in the output variables. Analyzing how a model responds to changes in input variables or how they interact can improve or diminish the model’s predictions by analyzing its response qualitatively or quantitatively [15].

After performing the sensitivity analysis, linear and quadratic relationships were determined between the input and output variables. Simple linear regression evaluates the relationship between two normally distributed variables, X & Y. Linear relationships between Y and X can be expressed as follows [16]:

$$Y = aX + c$$

where,

Y = dependent variable,  
 X = independent variable,  
 c = intercept, and  
 a = coefficient of the independent variable.

Quadratic regression evaluates the best fit for a data set shaped like a parabola. A quadratic regression model is an extension of simple linear regression. A quadratic relationship between Y and X can be expressed as follows [17]:

$$Y = aX^2 + bX + c, \quad \text{where } a \neq 0$$

where,

Y = dependent variable,  
 X = independent variable,  
 c = intercept,  
 a = coefficient of  $X^2$ , and  
 b = coefficient of X

Various combinations of input parameters were used to fit regression curves to the output parameters after the correlation and sensitivity analysis. For each combination, the  $R^2$  values were calculated and conclusions drawn. Combinations of the input parameters for the analysis are:

- I : P1, P2 & P3
- II : P1 & P3
- III : P1 & P2
- IV : P2 & P3

### 3. RESULTS AND DISCUSSION

A 7857 N [18] force was applied to the subsoiler blade while limiting its movement by fixing the holes Fig. 2. A structural analysis was performed. Input and output parameters of the structural analysis were exported to a parameter set for carrying out the parametric correlation. Parameter correlation studies typically use two types of linear correlation: Pearson and Spearman correlation. Pearson correlation is also known as linear correlation and has the full name of Pearson Product Moment Correlation. In this technique, two numerical data sets (variables) are related by an equation [19].

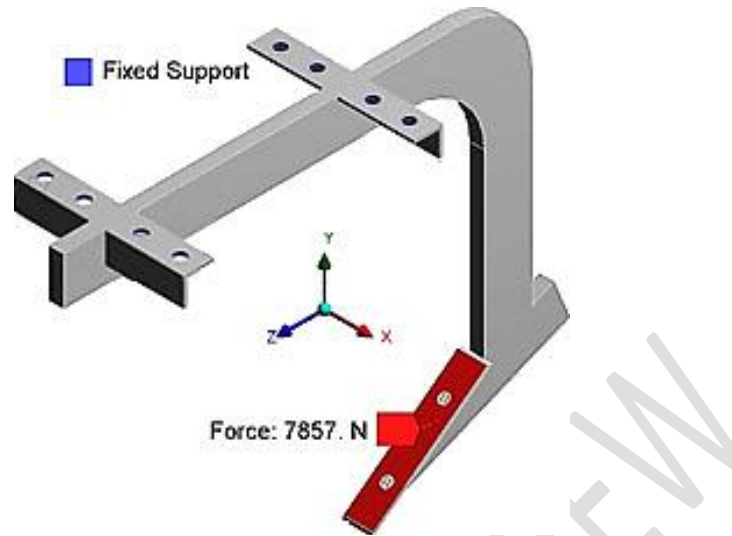

**Fig. 2. Force and constraints on the straight subsoiler**

In ANSYS, the results of the parameter study are presented in a correlation matrix. A correlation matrix shows the correlation between the input and output parameters. The correlation matrix explains the linear correlation between each input and output. Positive values indicate increasing linearity, while negative values are interpreted as inversely linear relationships [14]. The correlation matrix of the input and output parameters of the straight subsoiler is given in Table 1.

**Table 1. Correlation matrix of the input and output parameters of a straight subsoiler**

Name	P1	P2	P3	P4	P5	P6	P7	P8	P9
<b>P1</b>	1.000	0.032	0.031	0.789	-0.366	-0.648	-0.624	0.672	0.789
<b>P2</b>	0.032	1.000	0.003	0.046	0.017	-0.069	-0.075	0.083	0.046
<b>P3</b>	0.031	0.003	1.000	0.468	-0.772	-0.591	-0.592	0.627	0.468
<b>P4</b>	0.789	0.046	0.468	1.000	-0.410	-0.692	-0.782	0.743	1.000
<b>P5</b>	-0.366	0.017	-0.772	-0.410	1.000	0.799	0.618	-0.798	-0.410
<b>P6</b>	-0.648	-0.069	-0.591	-0.692	0.799	1.000	0.766	-0.980	-0.692
<b>P7</b>	-0.624	-0.075	-0.592	-0.782	0.618	0.766	1.000	-0.844	-0.782
<b>P8</b>	0.672	0.083	0.627	0.743	-0.798	-0.980	-0.844	1.000	0.743
<b>P9</b>	0.789	0.046	0.468	1.000	-0.410	-0.692	-0.782	0.743	1.000

P1 had a significant effect on P4, P6, P7, P8, and P9, with the correlation coefficients being 0.789, -0.648, -0.624, 0.672, and 0.789, respectively. P4, P8, and P9 have a positive correlation with P1. Increasing P1 will increase P4, P8, and P9. On the other hand, the relationship of P5, P6, and P7 with P1 is negative. Increasing P1 will decrease them. Since P1 significantly affects most output parameters, it is considered a major parameter.

The correlation coefficients of P2 with P4, P5, P6, P7, P8 and P9 are 0.046, 0.017, -0.069, -0.075, 0.083 and 0.046, respectively. All output parameters are negligibly affected by P2. P2 is therefore considered a minor parameter.

The effect of P3 was considerable on all the output parameters. The correlation coefficients of P3 with P4, P5, P6, P7, P8 and P9 are 0.468, -0.772, -0.591, -0.592, 0.627, and 0.468, respectively. Increasing P3 will increase P4, P8, and P9 while decreasing P5, P6, and P7. Since P3 also affects most output parameters, it is also considered a major input parameter.

	A	B	C	D	E
1	Filtering Method				
5	Major Input Parameters				
6	Input Parameter	Best Relationship With Filtering Output Parameter			
7		Relevance	Output Parameter	R2 Contribution	Correlation Value
8	P1 - Thickness of Shank	1	P4 - Straight Subsoiler Mass	0.60063	0.78919
9	P3 - Width of Shank	1	P5 - Total Deformation	0.59353	-0.77197
10	Minor Input Parameters				
11	Input Parameter	Best Relationship With Filtering Output Parameter			
12		Relevance	Output Parameter	R2 Contribution	Correlation Value
13	P2 - Length of Curve	0.37497	P7 - Maximum Principal Stress	0.019602	-0.074682

**Fig. 3. Summary of Parameters Correlation in ANSYS**

Fig. 3 summarizes the parameters correlation. There are two major input parameters, P1 and P3. Relevance (1.00) of P1 is highest with P4 with a correlation value of 0.78919 and R2 contribution of 0.60063. P3 has a relevance value of 1.00 with P5, a correlation value of -0.77197, and an R2 contribution of 0.59353. P2 is the minor input parameter having 0.37497 relevance with P6. The highest correlation value of P2 with P7 is -0.074682, and the R2 contribution of 0.019602.

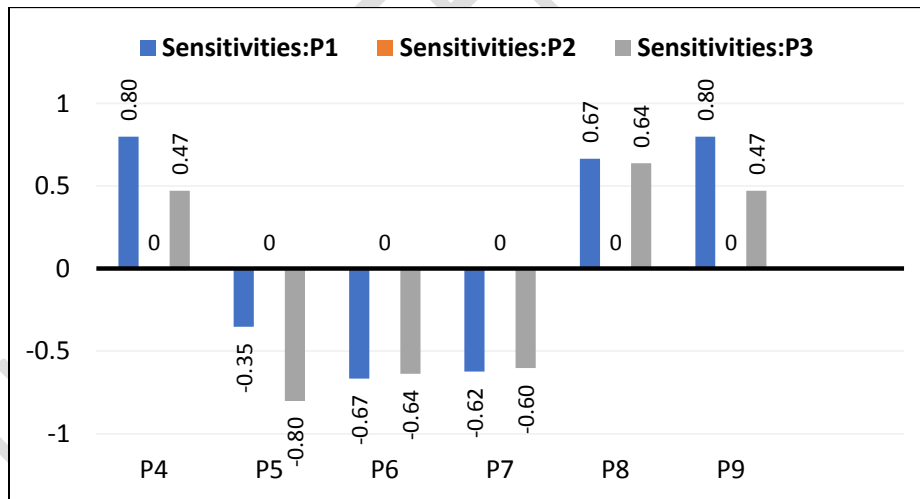
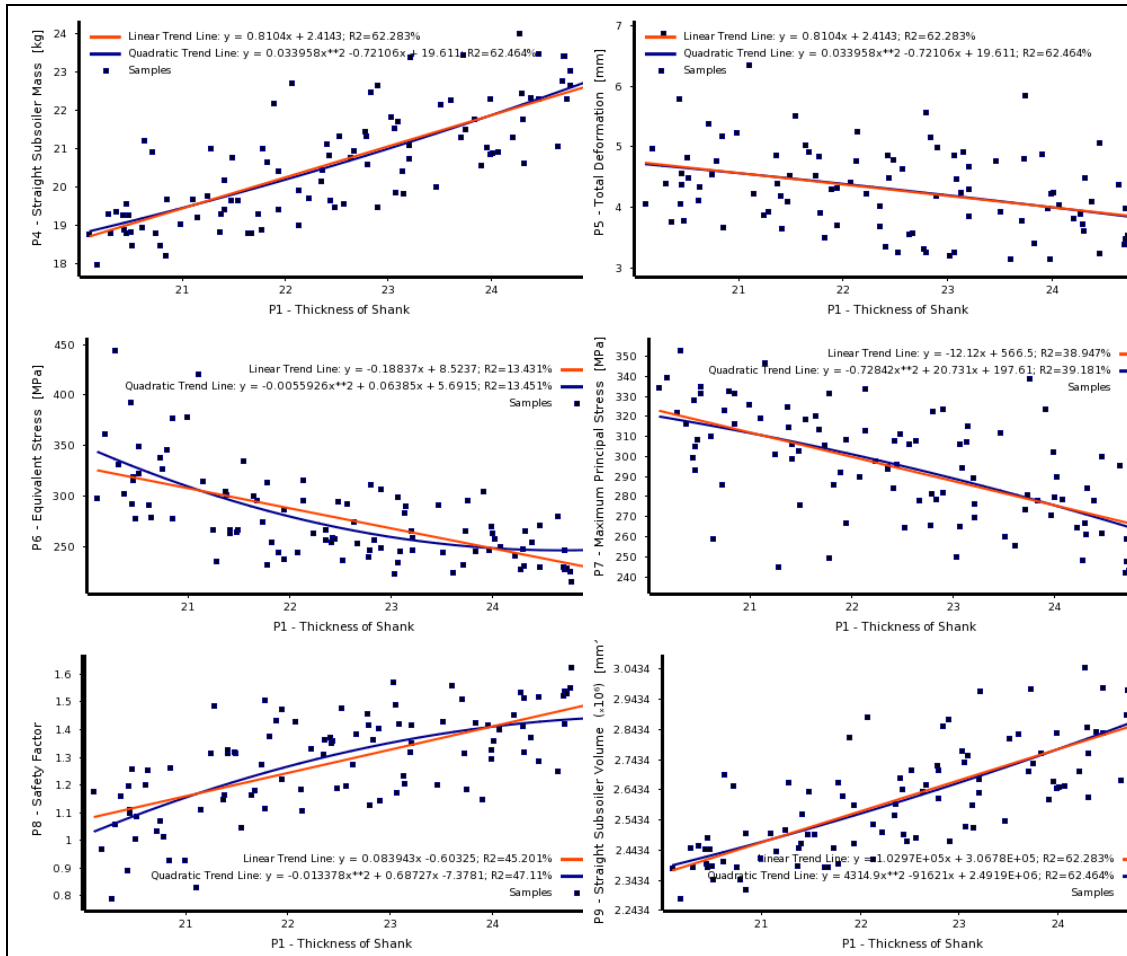

**Fig. 4. Sensitivities between input and output parameters of the straight subsoiler**

Fig. 4 illustrates the sensitivities between input and output parameters. Sensitivity analysis identifies priority areas for knowledge improvement [15]. P1 and P3 had positive and negative sensitivities in terms of output parameters, but P2 had zero sensitivity. All the output parameters responded to input parameters P1 and P3 changes. The response of P4, P6, P7, P8, and P9 was higher for changes in P1 than P3, while the response of P5 was higher for changes in P3 than P1. P4, P6,

P7, P8, and P9 responded more strongly for changes in P1 than for changes in P3, while P5 responded more strongly for changes in P3 than for changes in P1.

Additionally, linear and graphical relationships between input and output variables were determined. Fig. 5 shows the linear and quadratic relationships between P1 and the output variables, the equations, and the regression coefficients. Both linear and polynomial variations of each output parameter are represented for input parameter P1.



**Fig. 5. Linear and quadratic relationships between P1 and the output variables**

The maximum correlation was found between P1 and P4, and the linear and quadratic equations for the relationship are:

Linear:  $y = 0.8104x + 2.4143$ ;  $R^2 = 62.283\%$

Quadratic:  $y = 0.033958x^2 - 0.7211x + 19.611$ ;  $R^2 = 62.464\%$

where,

$y =$  P4 (Straight Subsoiler Mass), kg  
 $x =$  P1 (Thickness of Shank), mm

Linear and quadratic trend lines between P1 and the output parameters show that for P4, P8 and P9, increasing P1 increases the output parameter. On the other hand, increasing P1 decreases P5, P6, and P7.

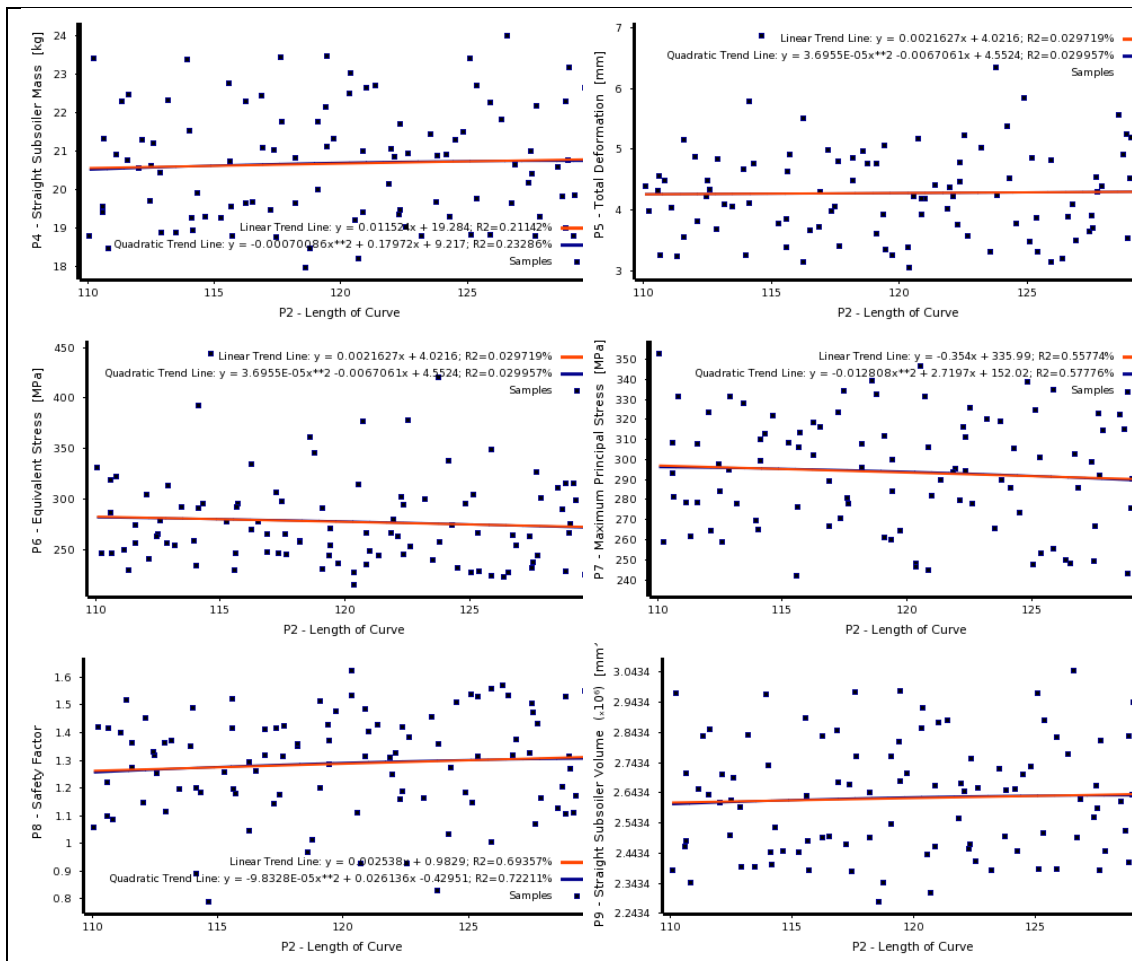

**Fig. 6. Linear and quadratic relationships between P2 and the output variables**

There was little correlation between P2 and the output parameters, so it was impossible to establish a significant relationship between input and output parameters. Fig. 6 shows the linear and quadratic relationships between P2 and the output parameters along with the equations and  $R^2$ .

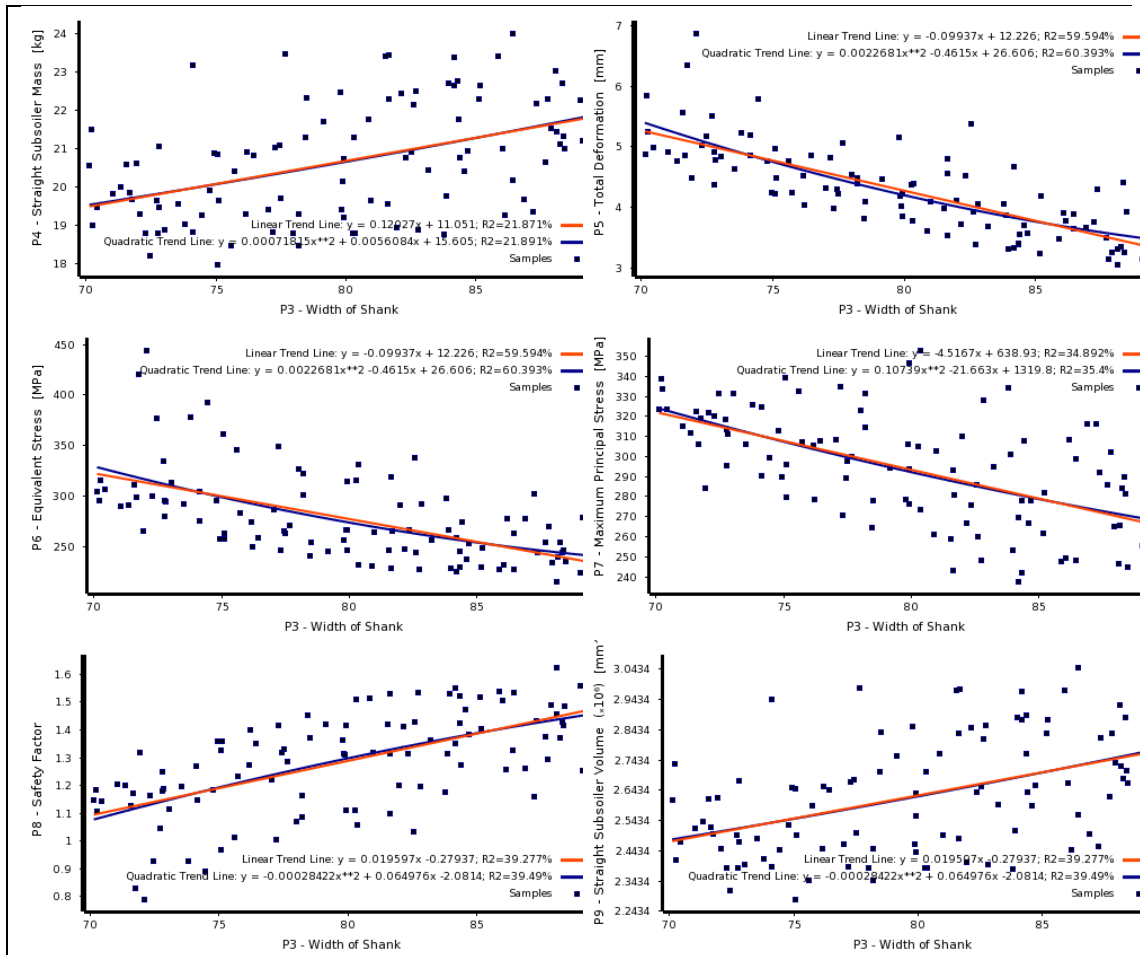

**Fig. 7. Linear and quadratic relationships between P3 and the output variables**

Fig. 7 depicts the relationship of P3 with the output variables. P3 and P5 were found to have the greatest correlation, and the linear and quadratic equations are as follows:

Linear:  $y = -0.0994x + 12.2259$ ;  $R^2 = 59.594\%$   
 Quadratic:  $y = 0.0022681x^2 - 0.4615x + 26.6062$ ;  $R^2 = 60.393\%$   
 where,

$y =$  P5 (Total Deformation), mm  
 $x =$  P3 (Width of Shank), mm

Linear and quadratic trend lines between P3 and the output parameters show that for P4, P8, and P9, increasing P3 increases the output parameter. On the other hand, increasing P3 decreases P5, P6, and P7.

Results from the parameters correlation analysis, sensitivity analysis, and the linear and quadratic regressions help classify the input parameters as major and minor input parameters. From the analysis, it was seen that P1 and P3 had high correlation and sensitivities with the output parameters. Moreover, the output

parameters varied due to changes in P1 and P3. In contrast, P2 had no correlation and sensitivity to the output parameters. There were no significant variations in the output caused by variations in P2. As a result, input parameters P1 and P3 were designated as major parameters, while P2 was designated as minor input parameters.

For determining the overall effects of the input parameters with their output parameters, comparative studies were conducted by fitting regression curves and obtaining  $R^2$  values. Fig. 8 illustrates changes in  $R^2$  with various combinations of input parameters.

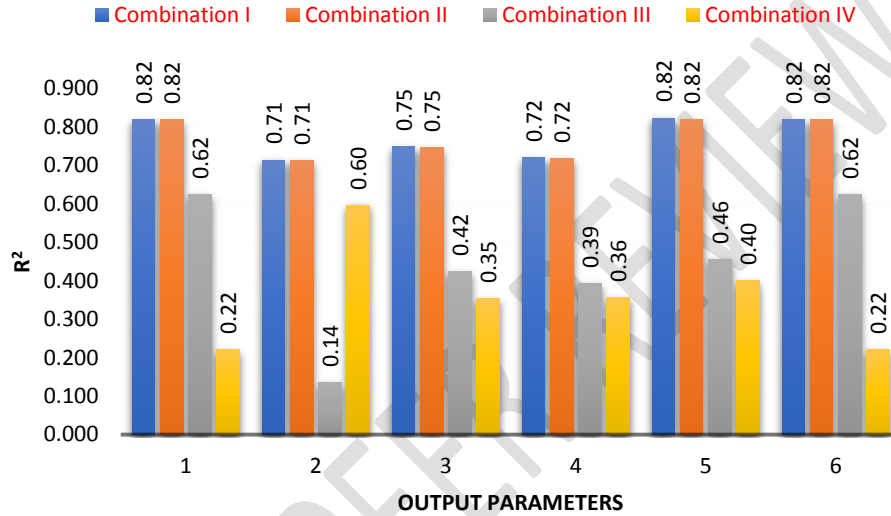

**Fig. 8. Comparison of  $R^2$  between different combinations of input parameters**

Combination II had almost the same  $R^2$  as combination I, indicating that not including P3 has no significant effect on the output parameters.  $R^2$  values of combinations III and IV were lower than those of combination II compared to combination I, confirming that P1 and P3 affected all output parameters significantly.

#### 4. CONCLUSION

An analysis of parametric correlation was conducted to determine the effects of input parameters, thickness of shank (P1), length of curve (P2), and width of shank (P3), on the output parameters straight subsoiler mass (P4), total deformation (P5), equivalent stress (P6), maximum principal stress (P7), safety factor (P8), and straight subsoiler volume (P9). The correlation analysis revealed that P1 and P3 had significant effects on the output parameters while P2 appeared to have a very low effect. In terms of defining relationships between the input and output parameters, quadratic relationships were better than linear ones. Increase in the values of P1 and P3 lead to increasing trends in P4, P8, and P9, and decreasing trends in P5, P6, and P7. The output parameters did not change as P2 was varied. Eliminating P2 from the analysis caused negligible changes in the model  $R^2$ . Thus, it can be concluded that a parameter correlation study is necessary to determine the

significance levels of the different input parameters. Understanding the significance of parameters can help better evaluate results from finite element analysis.

#### **COMPETING INTERESTS DISCLAIMER:**

Authors have declared that no competing interests exist. The products used for this research are commonly and predominantly use products in our area of research and country. There is absolutely no conflict of interest between the authors and producers of the products because we do not intend to use these products as an avenue for any litigation but for the advancement of knowledge. Also, the research was not funded by the producing company rather it was funded by personal efforts of the authors.

#### **REFERENCES**

1. Hang C, Gao X, Yuan M, Huang Y, Zhu R. Discrete element simulations and experiments of soil disturbance as affected by the tine spacing of subsoiler. *Biosyst Eng.* 2018; 168:73–82.
2. Shi Y, Yu Z, Man J, Ma S, Gao Z, Zhang Y. Tillage practices affect dry matter accumulation and grain yield in winter wheat in the North China Plain. *Soil Tillage Res.* 2016; 160:73–81.
3. Mossadeghi-Björklund M, Arvidsson J, Keller T, Koestel J, Lamandé M, Larsbo M, et al. Effects of subsoil compaction on hydraulic properties and preferential flow in a Swedish clay soil. *Soil Tillage Res.* 2016; 156:91–98.
4. Mouazen AM, Neményi M. Finite element analysis of subsoiler cutting in non-homogeneous sandy loam soil. *Soil Tillage Res.* 1999; 51(1–2):1–15.
5. Seth I, Simon O. Subsoiler development trend in the alleviation of soil compaction for sustainable agricultural production. *Int J Eng Invent.* 2018; 7(8):29–38.
6. Seth I. Subsoiler development trend in the alleviation of soil compaction for sustainable agricultural production. *Int J Eng Invent.* 2018; 7(8):29–38.
7. Dransfield P, Willatt ST, Willis AH. Soil-to-implement reaction experienced with simple tines at various angles of attack. *J Agric Engng Res.* 1964; 9:220–224.
8. Topakci M, Celik HK, Canakci M, Karayel D, Rennie A. Structural optimisation of a subsoiler. *Pak J Sci Ind Res.* 2010; 53(5):281–287.
9. Yıldırım A, Akay AA, Gülaşık H, Çöker D, Gürses E, Kayran A. Parameters Correlation Study To Investigate the Effects of Geometric Variables on the Safety of Bolted Flange Connections. In: 8th Ankara International Aerospace Conference. METU, Ankara Turkey: 2015. p. 1–17.
10. Topakci M, Celik HK, Canakci M, Rennie AEW, Akinci I, Karayel D. Deep

- tillage tool optimization by means of finite element method: Case study for a subsoiler tine. *J Food, Agric Environ.* 2010; 8(2):531–536.
11. Coro A. Flange-Designer: A New Flange Design Methodology Based on Finite Element Analysis. In: *International Ansys Conference.* 2001.
  12. Chen X, Liu Y. *Finite element modeling and simulation with ANSYS workbench.* CRC press; 2014.
  13. Yildirim A, Akay AA, Gulasik H, Gurses E, Coker D, Kayran A. Development of bolted flange design tool based on finite element analysis and artificial neural network. In: *ASME International Mechanical Engineering Congress and Exposition, Proceedings (IMECE).* 2015.
  14. Gogtay NJ, Thatte UM. Principles of correlation analysis. *J Assoc Physicians India.* 2017; 65(MARCH):78–81.
  15. Pichery C. Sensitivity Analysis. In: *Encyclopedia of Toxicology: Third Edition.* 2014. p. 236–237.
  16. Forthofer RN, Lee ES, Hernandez M. Linear Regression [Internet]. In: *Biostatistics.* Academic Press; 2007 [cited 2021 Dec 20]. p. 349–386.
  17. Banks DL, Fienberg SE. Statistics, Multivariate. In: *Encyclopedia of Physical Science and Technology.* Academic Press; 2003. p. 851–889.
  18. Allaie SP, Tripathi A, Dsouza PM, Parvaze S. Topology Optimization of a Straight Subsoiler through Computer Mathematical Modelling. *Curr J Appl Sci Technol.* 2020; 39(33):35–46.
  19. Emerson RW. Causation and Pearson's correlation coefficient. *J Vis Impair Blind.* 2015; 109(3):242–244.