

## Original Research Article

# Ultra violet and Visible light as Therapeutic tools for Covid -19

### ABSTRACT

Covid-19 is a disease which has become pandemic because of transmission of the tiny, single stranded virus, called SARS-CoV-2 or SARS-2. It has infected so far 168 million people with a death toll of 3.6 million in 210 countries. The world has seen worse pandemics but this COVID 19 is the most widespread in the human history quite probably due to the global travels.

A few vaccines for this disease is still in different stages of trial and acceptance and there are only three ways of prevention: 1. Avoiding crowds, 2. Wearing a mask when you go out and 3 Keeping hands clean.

What presented in this article are the innovations that employ light as the fourth dimension of corona prevention and therapy. One can use UVC (at 222 nm from an excimer lamp or LED or the fourth harmonic of Nd YAG laser at 266nm) for direct irradiation on oral cavity; or visible light (450 nm from blue LED or white light from a handy mobile) for photodynamic action with curcumin (of common house hold turmeric) as the photo sensitizer. Both could work as therapeutic tools of significant potency.

**Keywords:** Covid -19 prevention and therapy, UVC light at 222 or 266nm, Photo dynamic activity with curcumin – blue LED, mobile white light

### INTRODUCTION

A variety of diseases are caused by the microorganism such as mold, spore, fungi, bacteria and viruses, with the last two in the lower rungs of the ladder. A bacterium is a single-cell organism and exists all by itself without entering into the human cell. So, an antibiotic can be employed to kill a bacterium without any serious “collateral” damage to the adjoining human cell. This is not possible with the viruses as there are just RNA or DNA “virions” or “particles”, which can replicate only inside a cell feeding on the intra-cellular substances. Any attempt to eliminate a virus entails serious implication on the host cell.

The variety of viruses can be broadly classified as single strand RNA (SSR). Double stranded RNA (DSR), single stranded DNA (SSD), double stranded DNA (DSD). Out of these the recent

ravages caused by SAR 2 and the forerunners SAR 1 and MERS 1 all belong to SSR category. All three virulent strains are transmissible between humans.

Coronaviruses are round enveloped viruses and approximately 80 to 120 nm in size. They contain single stranded positive-sense RNA, with the largest RNA genome, approximately of 30 Kbp. A helical capsid within the viral membrane is formed by the RNA complexes with the basic nucleo-capsid (N) protein (Fig 1).

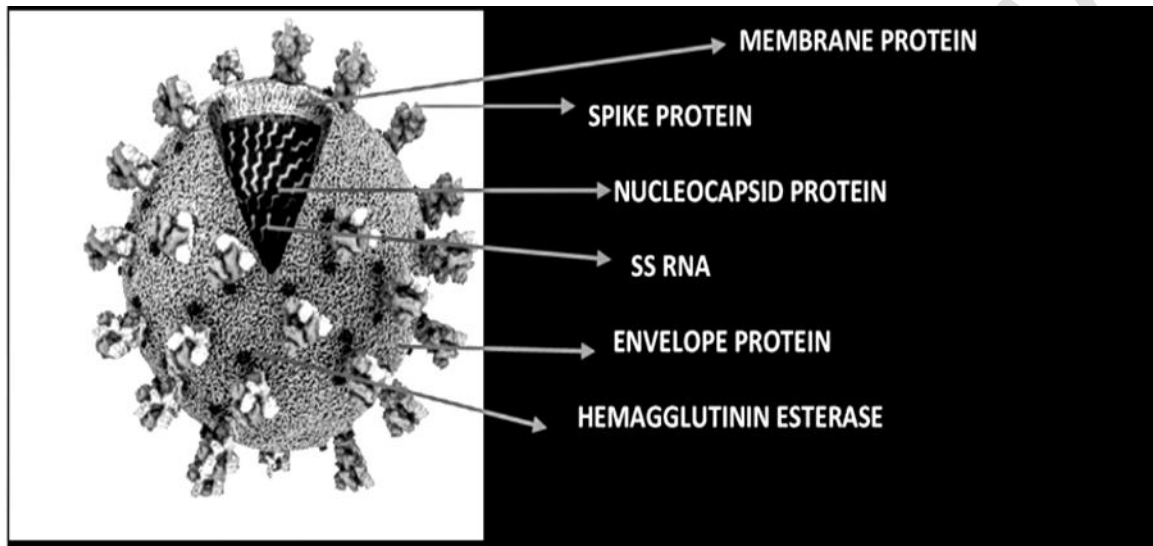

**Fig 1 :The cut -away structure of SARS-2 virus –(an artist view based on electron microscope image).**

The Corona virus contains three major proteins: Membrane protein (M), Spike protein (S), Envelope protein (E). Spike protein that facilitates the fusion and entry mechanism is subdivided into S1 and S2 regions, forming crown-like morphology (hence corona) of the virus as in the electron microscope. The entry of coronavirus into the host cells is mediated by the trans- membrane spike (S) glycoprotein homo trimers that are present all over and protrude from the viral surface. The functional receptor for the newly evolved corona virus is ACE2 receptor protein, (angiotensin-converting enzyme 2) . The domain B of S1 region in SARS-CoV-2 engages human ACE2 (hACE2) with higher affinity than SARS-CoV-1. The efficient transmission of SARS-CoV-2 in humans is partly explained by this tight binding; in addition, the receptor-binding domains undergo different conformational changes based on functions performed, due to rapid mutation.

The reason for recent SARS-2 variant's virulence is because of their flexible receptor binding domains and the possible covalent bonds between the ACE2 and the S-protein. In contrast, the corona viruses that cause the common cold are less dangerous because they are less flexible and the bond formation is less efficient. [1-4].

Like the other respiratory pathogens such as flu and rhinovirus, the transmission of SARS-CoV-2 occurs through respiratory droplets (aerosols) from coughing and sneezing or by being carried to oral cavity especially in closed areas or nasal mucosa by hands (fomites) from the virus-infested surfaces. The maximum incubation period from infection to appearance of symptoms is 14 days. The disease caused by SARS-CoV-2 is called the COVID-19.

Once the virus enters the host, it is mostly found in the upper respiratory tract (nasopharyngeal and pharyngeal) and then the lower respiratory tract. Once the virus reaches the airways, the spike protein binds to ACE2 on the surface of cells.

ACE2 is an enzyme present on epithelial cells of various tissues, which lines up and creates protective barriers. ACE2 is predominantly found on lung, heart, kidney, and intestinal cells, making these cells the target for infection by the virus. More often the virus infects the alveolar cells responsible for exchange of O<sub>2</sub> and CO<sub>2</sub>, consisting of ACE2 receptor (of alveolar T2 pneumocytes). Due to the damaged ACE2, the angiotensin (II) causes cell death.

The following are the major differences in the genomes among three virulent corona viruses though all contain the four nucleotides: adenine (A), guanine (G), and cytosine(C) thymine (T); bp= base pair

SARS CoV-1 : Genome full length (29759bp) | A(28% 8483) | T(33% 9145) | G(20% 6188) | C(19% 5943) ; infectivity parameter R 1.8% and fatality rate is 9.5%

SARS CoV-2: Genome full length (29903bp) | A(29% 8954) | T(34% 9594) | G(19% 5863) | C(18% 5492) ; infectivity parameter R 2.5% and fatality rate is 2.5%

MERS CoV: Genome full length (30119bp) | A(26% 7900) | T(34% 9799) | G(20% 6304) | C(20% 6116); infectivity parameter R 0.7 and fatality rate is 34.4%

The above data strongly indicate that Covid 1 and Covid 2 are structurally very similar but the latter one has become worldwide pandemic mostly because of over whelming global travels. This means the safest and simplest way to keep away from Covid 2 is to keep away from the crowd.

However, once someone has got infected the following light-based therapies are possible options, to be worked out as a realistic protocol, for partial or total recovery.

**Ultraviolet laser / light therapy :**

The COVID – 19, is an SSRNA virus and is the most vulnerable. It has a set of nucleotides (AGUC) as the genetic core and a set of glycoproteins in the spikes. The absorption spectra of these nucleotides are given below in Fig 2 [5-8]

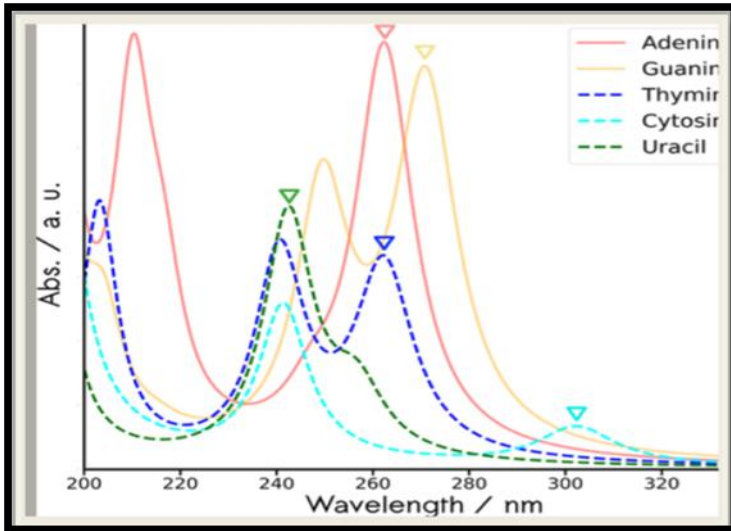

**Fig 2 The UV Absorption spectra of nucleotides of the virus**

Since these nucleotides are conjugated aromatic molecules, they have strong absorption  $\epsilon = 10,000$  lit/mole, with the peaks from 245 to 277nm. In addition, the glycoprotein consists mainly of tryptophan which also has absorption peak 275nm.

The instrument will be a portable ultraviolet Nd-YAG laser working at 266nm (fourth harmonic) or the excimer lamp /or LED at 220 nm or LED at 275 nm (See Fig 3). Each has its own advantages and limitations. Whatever be source the average power could be optimized to 10 mw. This will be used to “spray of photons” to disinfect surfaces. Whereas the LED is the best and inexpensive for shining as a cone, the laser beam can be launched into a quartz optical fiber and even upper part of lungs could be accessed through suitable endoscopes. The duration of spray will be of few (5 -10) seconds, repeated thrice, with few minutes interval-based trial and errors.

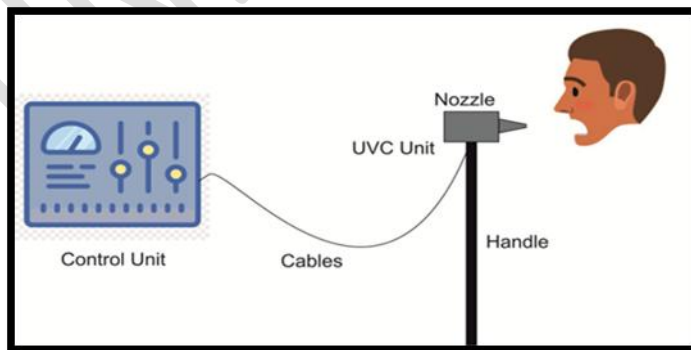

### Fig 3 UVC laser spray into the mouth

This will ensure a total dose of  $2 \text{ mJ/cm}^2$  area (which amounts to  $3 \times 10^{15}$  photons in a penny size area). In a systematic in vitro study done by a host of others mostly on SARS-1 and 2, this is an optimal dose at 254 to 275 nm without any side effect on substratum cells [8-10]. This dose, obtainable easily from 20 mw LED at 275nm available in the market, is quite effective in hand sanitization [9-13] without any adverse effect on the skin surface of the hands. Even better would be LED or lamp at 222nm.

As shown by Manuela Buonanno, et al [14] the cells ( of size 500nm or more ) of the tissue scatter away most of the incident light ,practically no absorption takes place, hence no damage to the cells at this wavelength; but corona could be deactivated because the virus is of 80nm size and absorbs this light and gets killed; this would be the ideal UV source for sanitizations of any part of the body. There are 5w or 12w Kr Cl excimers lamps from which an intensity of at  $100 \text{ microwatt/cm}^2$  is obtainable; or LEDs are obtainable but the power levels are about only 1mw or even less; In addition the cost, durability of product are yet to be optimized; in spite of all these constraints LEDs at 222nm are very promising for UV radiation therapy of Covid 19.

It is important to reiterate that a virus has a number of biomolecules of broad band absorption so that a laser at 266 nm or, or super luminescent diodes at 222,255, 265 or 275 nm all can be effectively employed. Among them, pico-sec laser will be much more effective because the short duration photon shower, like a volley of bullets, will do ablation, just breaking the bonds to produce photo-dimers and thereby disrupting the viral replication process. Such picosecond or femtosecond pulses have proved very successful in photorefractive kerectomy (PRK) with selective impact on the target with negligible collateral damages.

The only concern in the whole modality is the possible side effect of UVC. Three considerations can be pondered: 1) The irradiance and fluency could be so carefully chosen that it is too high for the virus and too low for the normal cells. In fact, according to the two well-known reports [10-13 ] the threshold level for 90 percent germicidal effect (LD90 for Covid 19 by UVC is only  $1.1 \text{ mJ/cm}^2$  but the damage threshold of skin is  $4.2 \text{ mJ/cm}^2$ . Thus, a dose of  $2 \text{ mJ/cm}^2$  is found to be optimal. 2) It is important to note that UVC is absorbed only by 3% by the skin tissues (see figure 4); so, it is UVB more hazardous than UVC. [9]



Fig 4 Hand held LED nose spray

Out all the possibilities LED at 222 nm as a hand-held device for irradiation for the upper part and the mode locked Nd YAG laser at 266 for endoscopic irradiation appear to be best choice

The worst that could happen is erythema and some inflammation which could be taken care of by the physician with suitable medication and rest for patient.

Before the procedure, the mucous from the nose or respiratory tract of the patient must be taken up out for counting (using RT-PCR or any other suitable method) viral population: then after “light spray” viral population will be evaluated again for assessing the efficacy of the light therapy.

This could achieve at least 50% reduction in the viral load and hence the severity of disease and mortality rate. In addition, the patient can carry a hand –held photon sprayer, (see figure 5) as a take- home companion, to eliminate periodic cleaning (something similar to medicated aerosol sprayer used for asthma patients). On this account LED at 222nm scores over all others.

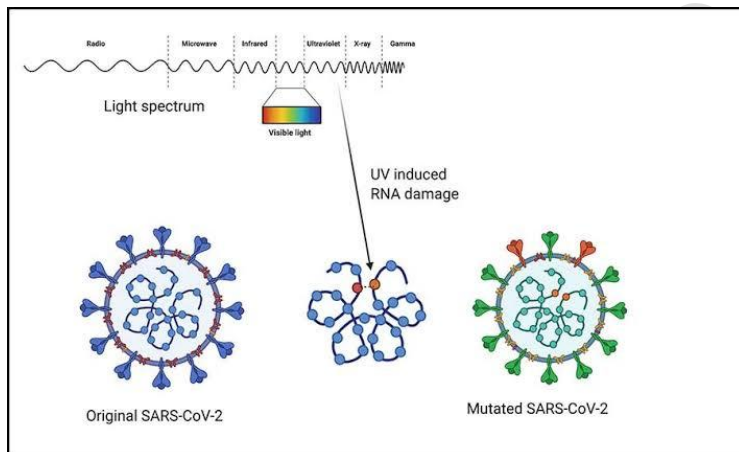

The above diagram clearly portrays how the single stranded RNA housed safely inside thin protein enclosure get hit by the UV photon which snaps the H bond (shown as black dots) between two nucleotides ( shown as red balls ). This leads to mutation and the arrest of replication.

**Fig 5 Photon induced damages by the UVC light**

It will be best during and after treatment for the suspected cases in the quarantine period. All the above are based on two essential concepts: that substantial number of viral population are available on the surface , outside the cells , (before being “ushered in” by the ACE2 receptor and also when they migrate out of first host and in search of the next) so

that the photons can hit them hard and decimate them and reduce their population; and third that there is a threshold viral population for the onset of disease and that ultraviolet photons need to bring the viral load below this threshold. All these are reasonable expectations and realizable objectives. [15,16]

### **Photodynamic Activity of Curcumin in Conjunction with the Blue LED**

Turmeric (with curcumin as the main molecular composition) is a household spice called the "golden spice", due to the multifarious medical use and also its color. The technical specifications for the effective use of this phytochemical for the prevention or mitigation of the present COVID -19 pandemic are outlined below.

There are quite a few photosensitizers more popular than curcumin such as photofrin for cancer treatment and methylene blue for anti- bacterial anti- fungal germicidal impacts. But there are certain overwhelming advantages of employing curcumin (the essential chemical in the turmeric) for corona prevention. First and foremost, it a common household herb that has been used in food stuffs in a variety of ways over few million people in tropical or East Asian countries over a few hundred years.

In addition, it is being employed as cosmetic on the face and different parts of the body by many women folk, again over a few hundreds of years. Thus, it is a time-tested-phytochemical for internal and external applications with proven short term and long-term safety.

Secondly, it is an FDA (of the USA) approved drug, one of the few from the East, to pass through the modern scientific rigors of the West. Further, the phytochemical property of turmeric in controlling CVD (cardio vascular diseases), cancers, and liver diseases have been proved in over 300 clinical trials [16-25]. In addition, it is proven to be antiviral, anti-bacterial, anti-inflammatory and antifungal. Curcumin has been shown to elicit a strong antioxidant activity by directly scavenging free radicals, even more effectively than vitamin E.

Interaction between the invading Corona Virus and the epithelial cell of upper and lower respiratory track maybe summed up again as below:

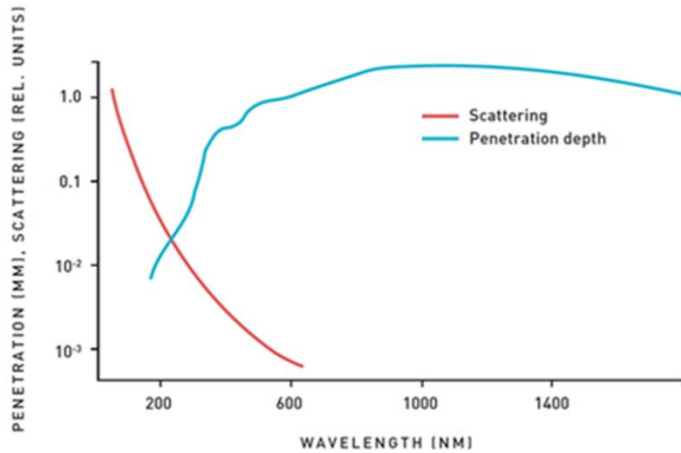

**Fig 6 Depth of penetration for different UV light**

This single stranded RNA virus makes use of its spike protein of the virus to lock with ACE2 receptor enzyme and gains entry into the cell. Once in, it makes use of the extra-nuclear material of the host cell, for its own replication, then leading to the mal- function and decay of the host cell. After ravaging, the multiplied corona virus can break open the host to invade to the neighboring cells. (see fig 7).

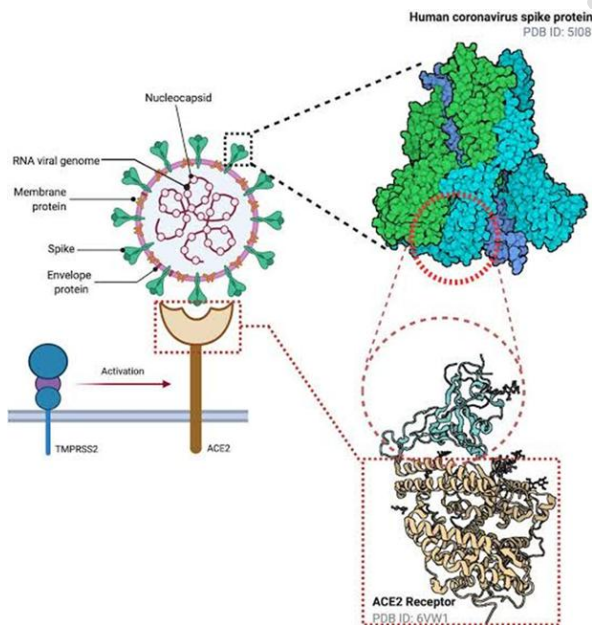

**Fig 7 SAR2 latching on to the ACE2 receptor – lock and key mechanism**

The small phytochemical curcumin is capable of curtailing the corona replication in three steps: 1) corroding the virus envelope, 2) inter-chelating between the spike protein of the virus and the ACE2 receptor of the host. That is, the “hand shake” between the virus and the receptor enzyme is hindered. 3) The curcumin is capable of modulating host cell signaling

pathways (NF- $\kappa$ B, DI3K-AKI) and also transcription machineries, which disrupts the virus replications inside the cell. (See fig 8)

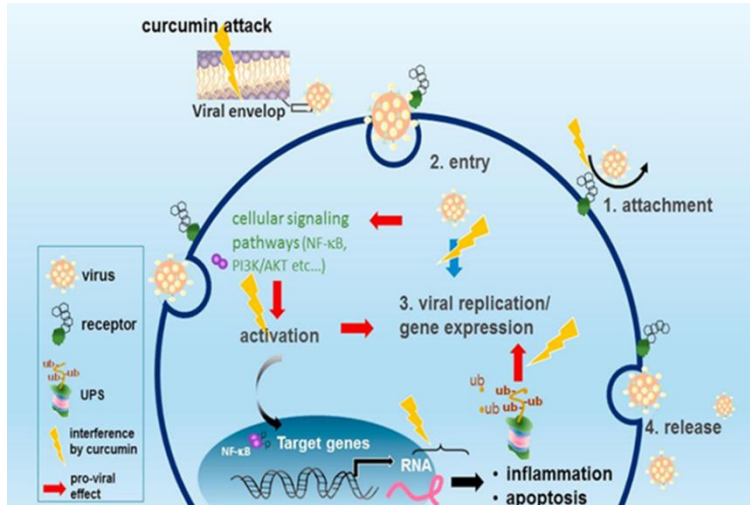

**Fig 8 The small phytochemical curcumin is capable curtailing the corona replication in many steps as represented in the figure**

All the above mechanism has been observed to get enhanced many times by the photo dynamic activity (PDA) with the help of a blue light.

The dynamics of PDA maybe outlined as below:

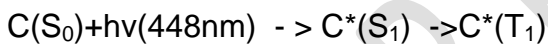

That is, the curcumin molecule (C) has a strong absorption at 448 nm (see fig 9) and when irradiated with the blue light at 448 nm available from blue LED (see fig 10) most of the molecules get excited to  $S_1$  state from the ground  $S_0$  state. From here, they relax to the triplet state ( $T_1$ ) where they linger about 100nanoseconds producing singlet oxygen and photo-radicals which destroy the nearby viruses. This is the well-known photodynamic activity employed commonly in skin cancer treatment and also for antiviral activities [16-19]

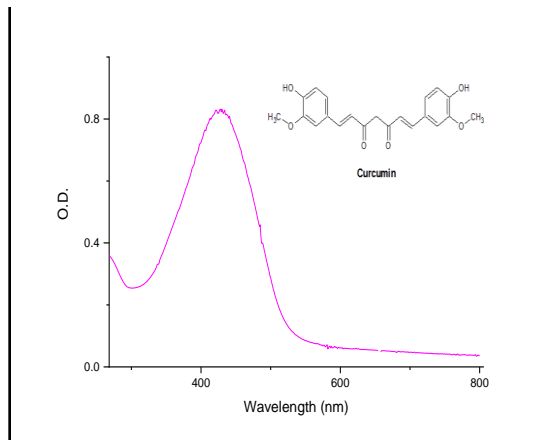

Fig 9. Absorption spectra of curcumin the major content in turmeric

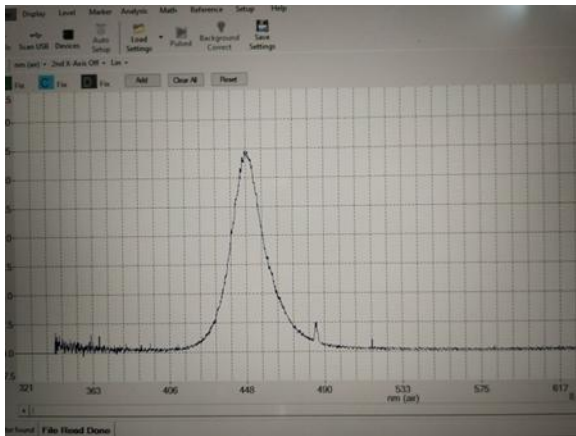
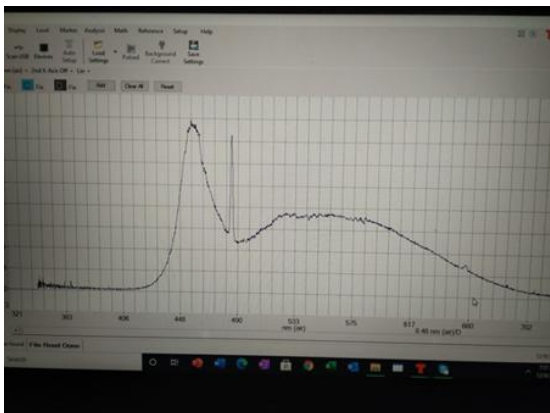

Fig 10. The emission profile of common blue LED

## 2. METHODOLOGY

### *The Actual execution of this PDA therapy can be outlined as below*

About 10 mg of turmeric available in any herbal shop is dissolved in 100 ml of warm water; it will be a yellow liquid since turmeric is only partly soluble and remains as a suspension in water. This yellow liquid must be used to rinse the mouth a few times so that the turmeric gets coated all over the oral cavity; then the whole mouth cavern must be irradiated with blue light from LED for 5 minutes. (FIG 11). This dose of photosensitizer and light will be sufficient to reduce significant level of corona infection.



**Fig 11 The emission profile of white LED of any mobile**

In order to verify the above contention, we very much tried to do such an experiment with the actual SARS-2, the causative virus for the pandemic Covid -19, but could not accomplish it due to stringent Governmental protocols in this time of emergency; hence, we just did the second best.

We carried out the experiment on the bacterium staphylococcus aureus suspension treated with turmeric with a concentration of 1mg/ml. The media and the reagents were the well-known set: 0.9% NaCl, Soybean Casein Digest agar and Lethean broth. The light source was a ring five LEDs each of 0.25 w power at 448nm. The exposure time varied from 75 seconds, 150 seconds and 300seconds.

Bacterial strain used in this study was staphylococcus aureus (ATCC 6538). They were cultured in Soyabean Casein digest Agar (SCDA) aerobically at 37°C and were grown for 24 hours. The colonies were collected with the loop of 100  $\mu$ L and inoculated into 5 mL of SCDM broth. For the quantification of colony-forming units (CFU), the suspension was standardized by measuring absorbance at in a photometer to an optical density of 0.5 Macfarland at a wavelength of 620 nm, corresponding to approximate numbers  $1.5 \times 10^8$  CFU.

Samples were divided into four groups. Group A: untreated Bacterial suspension. Group B: Bacterial suspensions in the presence of curcumin at concentration of 1 mg/mL. Group C: Bacterial suspensions irradiated with blue light (450 nm) in the absence of photosensitizer. Group D: Bacterial suspensions irradiated with blue light (450 nm) in the presence of concentration of 1 mg/mL of Curcumin. Group C and D went through a contact period of 1.15 minutes, 2.30 minutes and 5minutes.

After completion of contact time, 1m1 each group test plate had 10fold serial dilutions in sterile diluents (up to  $10^{-6}$ ) and plate the dilutions in duplicate, to the SCDA media. They were incubated at 32.5° C for 24 - 48 hours.

At the end of the incubation period, viable colony counts were measured as outlined above ; and the whole procedure was done twice and then the arithmetic mean was obtained. The final report was made as shown in Table I which showed significant germicidal impact on the microorganism by the combined effect of blue light and the curcumin chemical.

It is important to note that the above bacterium is at least five times tougher, bigger unicellular organism with a well defined cell wall and organelle whereas the SARS-2 is a single stranded tiny RNA virion with a flimsy protein envelope. Hence PDA would be effective even with much less chemical and light as had been shown by others too for other viruses [20-22]

### **Mobile LED instead of blue LED**

What more interesting is that these days almost everybody carries a mobile phone which has a white LED light. The spectral distribution of white LED is exactly same as blue LED cited above (FIG 11). The only difference is the additional broad fluorescence band at 600nm coming out of the coating made on the inner walls of LED (This technique was a take- off from the conventional mercury lamp or tube light). The above experimental protocol with turmeric on the same bacterium was repeated with the five LED white light from the five mobile phones. It showed an efficiency 90% what we could obtain with 448 nm blue LEDs

### **3. RESULT AND DISCUSSION**

The final result as shown in Table I showed significant germicidal impact on the microorganism by the combined effect of blue light and the curcumin chemical.

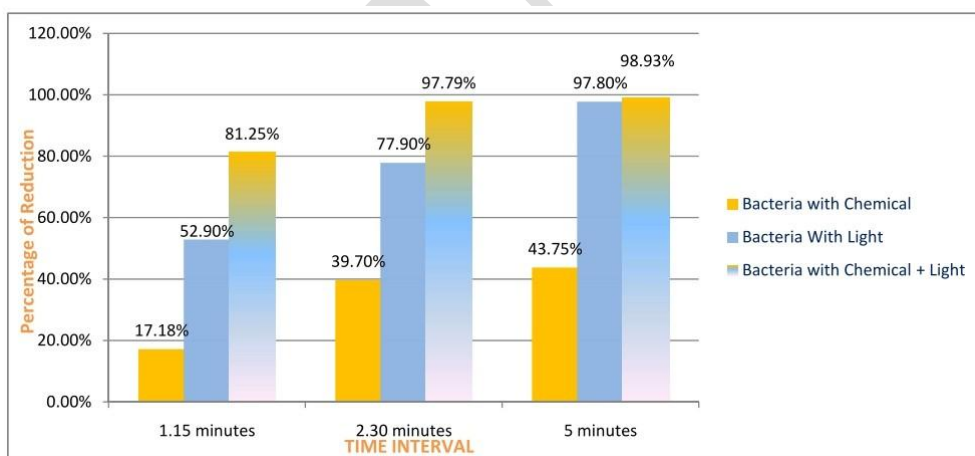

TIME INTERVAL

|                                       | 1.15 minutes | 2.30 minutes | 5 minutes |
|---------------------------------------|--------------|--------------|-----------|
| <b>Bacteria with Chemical</b>         | 17.18%       | 39.70%       | 43.75%    |
| <b>Bacteria With Light</b>            | 52.90%       | 77.90%       | 97.80%    |
| <b>Bacteria with Chemical + Light</b> | 81.25%       | 97.79%       | 98.93%    |

**Table.1 & Fig. 12 Photodynamic action of blue light in conjunction with curcumin on a bacterium, Staphylococcus aureus**

It is important to note that the above bacterium is at least five times tougher, bigger unicellular organism with a well-defined cell wall and organelle whereas the SARS-2 is a single stranded tiny RNA virion with a flimsy protein envelope. Hence PDA would be effective even with much less chemical and light as had been shown by others too for other viruses [20-22]

The above PDA can be employed almost anybody anywhere with a bit of turmeric and shine of white light from the handy mobile. There is no need for any medical intervention as both turmeric and light are quite safe. Curiously enough if a person can rinse his mouth in turmeric water and keep his mouth open for 30 seconds in the morning sun (keeping the eyes closed!) that would give a total of  $150 \text{ mJ/ cm}^2$  which could be of substantial corona preventive effect. (This calculation is done based on the fact that the average solar energy is  $170\text{W/m}^2$ ).

In addition to all the above, those who are not specifically allergic to turmeric (suffering from stomach acidity) can swallow a 50ml of turmeric water too. (It should be done after consulting your physician). Such an intake of turmeric is a potential drug against cholesterol, triglyceride and blood glucose. This, by itself is a very valuable direct advantage; what additional advantage is the reduction in the atherosclerosis in the blood vessels, which reduces ACE2 receptor, which in turn reduces the chances of getting infected by SARS CoV-2 [7-8].

## Conclusion

In this report, new laser / light based therapeutic modalities are proposed to reduce substantial viral load in patients infected with COVID-19. The first one is based on laser/LED induced breakdown of H- bonds or photo reaction on biomolecules of the virus. The source could be preferably picosecond pulses from a UVC laser at 266nm or LED at 222nm. By carefully adjusting the irradiation and fluency, the thin layer of virus population lingering outside the cell, (waiting for the entry, or reentry in to the next loot), could be decimated with minimal collateral damage to the host cells. The use wavelength in the far UV (220 nm) efficiently kills pathogens without harming substratum human tissues. It can become a hand -held device like an inhaler for asthma patients

The second approach is the photo-dynamic action employing blue LED (448nm or mobile phone white light) and common “gold spice” turmeric. In this case, the light as well as the sensitizers are time -tested safe tools. In the absence of any pharmaceutical solution and enough vaccines to the disease these are plausible alternatives. However, none of these has been tested on the SARS2 virus by us for the single most reason that we are NOT allowed access to the virus or the patients in this hectic time of emergency. Those who have such access must take up this and confirm it.

## References

1. Park, Su Eun. 2020. “Epidemiology, Virology, and Clinical Features of Severe Acute Respiratory Syndrome -Coronavirus-2 (SARS-CoV-2; Coronavirus Disease-19).” *Clinical and Experimental Pediatrics* 63 (4). <https://doi.org/10.3345/cep.2020.00493>.
2. Zimmermann, Petra, and Nigel Curtis. 2020. “Coronavirus Infections in Children Including COVID 19.” *The Pediatric Infectious Disease Journal* 39 (5): 1. <https://doi.org/10.1097/inf.0000000000002660>.
3. Vinod, Nikhra. 2020. “Exploring Pathophysiology of COVID-19 Infection: Faux Espoir and Dormant Therapeutic Options.” *International Journal of Clinical Virology* 4 (1): 034–40. <https://doi.org/10.29328/journal.ijcv.1001013>.
4. Li, Xiaowei, Manman Geng, Yizhao Peng, Liesu Meng, and Shemin Lu. 2020. “Molecular Immune Pathogenesis and Diagnosis of COVID-19.” *Journal of Pharmaceutical Analysis* 10 (2). <https://doi.org/10.1016/j.jpha.2020.03.001>.
5. Goodsell, David S., Shuchismita Dutta, Christine Zardecki, Maria Voigt, Helen M. Berman, and Stephen K. Burley. 2015. “The RCSB PDB ‘Molecule of the Month’: Inspiring a Molecular View of Biology.” *PLOS Biology* 13 (5): e1002140. <https://doi.org/10.1371/journal.pbio.1002140>.
6. Kothekar, Dr.Vidya. n.d. “Course : PG Pathshala-Biophysics Paper 10 : TECHNIQUES USED in MOLECULAR BIOPHYSICS II (Based on Spectroscopy) Module 10 : Absorption Spectroscopy of Nucleic Acids: DNA and Rna, Nucleic Acid Bases; Estimation of Concentration, DNA Purity, Homogeneity.” [http://epgp.inflibnet.ac.in/epgpdata/uploads/epgp\\_content/S001174BS/P001858/M030435/ET/1526639139P10\\_M10\\_ET.pdf](http://epgp.inflibnet.ac.in/epgpdata/uploads/epgp_content/S001174BS/P001858/M030435/ET/1526639139P10_M10_ET.pdf).
7. Weiss, S. R., and S. Navas-Martin. 2005. “Coronavirus Pathogenesis and the Emerging Pathogen Severe Acute Respiratory Syndrome Coronavirus.” *Microbiology and Molecular Biology Reviews* 69 (4): 635–64. <https://doi.org/10.1128/membr.69.4.635-664.2005>.
8. Tang, Xianchun, Gang Li, Nikos Vasilakis, Yuan Zhang, Zhengli Shi, Yang Zhong, Lin-Fa Wang, and Shuyi Zhang. 2009. “Differential Stepwise Evolution of SARS Coronavirus Functional Proteins in Different Host Species.” *BMC Evolutionary Biology* 9 (9): 52. <https://doi.org/10.1186/1471-2148-9-52>.

9. Wu, Fan, Su Zhao, Bin Yu, Yan-Mei Chen, Wen Wang, Zhi-Gang Song, Yi Hu, et al. 2020. "A New Coronavirus Associated with Human Respiratory Disease in China." *Nature* 579 (7798). <https://doi.org/10.1038/s41586-020-2008-3>.
10. Tseng, Chun-Chieh, and Chih-Shan Li. 2005. "Inactivation of Virus-Containing Aerosols by Ultraviolet Germicidal Irradiation." *Aerosol Science and Technology* 39 (12): 1136–42. <https://doi.org/10.1080/02786820500428575>.
11. Vatansever, Fatma, Cleber Ferraresi, Marcelo Victor Pires de Sousa, Rui Yin, Ardeshir Rineh, Sulbha K Sharma, and Michael R Hamblin. 2013. "Can Biowarfare Agents Be Defeated with Light?" *Virulence* 4 (8): 796–825. <https://doi.org/10.4161/viru.26475>.
- 12 JohnStrisower : Method and apparatus for UVC for germicidal irradiationUS patent US 2005/0256553 A1 2005
13. V Masilamani and R Sabarikanth " Novel ultra violet laser therapy for COVID-19- A Promising Technology " - Indian Patent Pending submitted - April 2020.
14. Buonanno, Manuela, David Welch, Igor Shuryak, and David J. Brenner. 2020. "Far-UVC Light (222 Nm) Efficiently and Safely Inactivates Airborne Human Coronaviruses." *Scientific Reports* 10 (1): 1–8. <https://doi.org/10.1038/s41598-020-67211-2>.
15. Madu, I. G., S. L. Roth, S. Belouzard, and G. R. Whittaker. 2009. "Characterization of a Highly Conserved Domain within the Severe Acute Respiratory Syndrome Coronavirus Spike Protein S2 Domain with Characteristics of a Viral Fusion Peptide." *Journal of Virology* 83 (15): 7411–21. <https://doi.org/10.1128/jvi.00079-09>.
16. Bosch, Berend Jan, Ruurd van der Zee, Cornelis A. M. de Haan, and Peter J. M. Rottier. 2003. "The Coronavirus Spike Protein Is a Class I Virus Fusion Protein: Structural and Functional Characterization of the Fusion Core Complex." *Journal of Virology* 77 (16): 8801–11. <https://doi.org/10.1128/JVI.77.16.8801-8811.2003>.
17. Almeida, Adelaide, M. Amparo F. Faustino, and Maria G. P. M. S. Neves. 2020. "Antimicrobial Photodynamic Therapy in the Control of COVID-19." *Antibiotics* 9 (6): 320. <https://doi.org/10.3390/antibiotics9060320>.
18. Randazzo, W., R. Aznar, and G. Sánchez. 2016. "Curcumin-Mediated Photodynamic Inactivation of Norovirus Surrogates." *Food and Environmental Virology* 8 (4): 244–50. <https://doi.org/10.1007/s12560-016-9255-3>.
19. Zahedipour, Fatemeh, Seyede Atefe Hosseini, Thozhukat Sathyapalan, Muhammed Majeed, Tannaz Jamialahmadi, Khalid Al- Rasadi, Maciej Banach, and Amirhossein Sahebkar. 2020. "Potential Effects of Curcumin in the Treatment of COVID - 19 Infection." *Phytotherapy Research*, June. <https://doi.org/10.1002/ptr.6738>.

20. Dai, Chongshan, Xiuying Zhang, and Keyu Zhang. 2020. "New Discovery of Curcumin Combination Therapy and Action Mechanism." *Evidence-Based Complementary and Alternative Medicine*. March 10, 2020. <https://www.hindawi.com/journals/ecam/2020/4793058/>.
21. Araújo, Natália Costa, Carla Raquel Fontana, Marleny Elizabeth Martinez Gerbi, and Vanderlei Salvador Bagnato. 2012. "Overall-Mouth Disinfection by Photodynamic Therapy Using Curcumin." *Photomedicine and Laser Surgery* 30 (2): 96–101. <https://doi.org/10.1089/pho.2011.3053>.
22. Wu, Juan, Wei Hou, Binbin Cao, Tao Zuo, Changhu Xue, Albert Wingnang Leung, Chuanshan Xu, and Qing-Juan Tang. 2015. "Virucidal Efficacy of Treatment with Photodynamically Activated Curcumin on Murine Norovirus Bio-Accumulated in Oysters." *Photodiagnosis and Photodynamic Therapy* 12 (3): 385–92. <https://doi.org/10.1016/j.pdpdt.2015.06.005>.
23. Zorofchian Moghadamtousi, Soheil, Habsah Abdul Kadir, Pouya Hassandarvish, Hassan Tajik, Sazaly Abubakar, and Keivan Zandi. 2014. "A Review on Antibacterial, Antiviral, and Antifungal Activity of Curcumin." *BioMed Research International*. April 29, 2014. <https://www.hindawi.com/journals/bmri/2014/186864/>.
24. Mohammadian Haftcheshmeh, Saeed, Mohammad R. Karimzadeh, Sara Azhdari, Parviz Vahedi, Elham Abdollahi, and Amir A. Momtazi-Borojeni. 2019. "Modulatory Effects of Curcumin on the Atherogenic Activities of Inflammatory Monocytes: Evidence from in Vitro and Animal Models of Human Atherosclerosis." *BioFactors* 46 (3): 341–55. <https://doi.org/10.1002/biof.1603>.
25. Kapakos, Georgia, Viktoria Youreva, and Ashok Srivastava. 2012. "Cardiovascular Protection by Curcumin: Molecular Aspects." *Indian Journal of Biochemistry & Biophysics* 49: 306–15. [http://nopr.niscair.res.in/bitstream/123456789/14830/1/IJBB%2049\(5\)%20306-315.pdf](http://nopr.niscair.res.in/bitstream/123456789/14830/1/IJBB%2049(5)%20306-315.pdf).