

## Review Article

# A Review about Better Analytical Technique for Determining Febuxostat in the Blood Plasma for Bioavailability and Bioequivalence Studies

### Abstract

This comprehensive review provides a pioneering analysis of the instrumental role of Liquid Chromatography with Mass Spectrometry (LC-MS) in unraveling the bioavailability and bioequivalence of Febuxostat (FBS) in human plasma. Utilizing Febuxostat d9 and d7, along with other drugs as internal standards (IS), the review steers through the intricate view of pharmaceutical research, focusing on validation methods and the challenges presented by the complex pharmacokinetics of FBS. Unprecedented in its depth, the review aims to contribute valuable insights to the field by addressing the evolving paradigms in pharmaceutical analysis. FBS, a revolutionary advancement in the treatment of hyperuricemia and gout, takes center stage, highlighting its pivotal role in contemporary therapeutic approaches. LC-MS develops as a cornerstone analytical method for studying FBS, offering unparalleled sensitivity and selectivity. The review delves into the sample preparation techniques, emphasizing the significance of protein precipitation and liquid-liquid extraction in extracting FBS from human blood plasma. LC-MS/MS, chosen for its exceptional sensitivity and specificity, becomes a focal point in FBS analysis, with IS employed to enhance accuracy. The optimization of chromatographic conditions, encompassing the careful selection of stationary and mobile phases, is highlighted as crucial for establishing a robust and reliable LC method, ensuring accuracy in pharmacokinetic studies of FBS. This concept encapsulates the essence of the review, positioning LC-MS as a superior analytical technique for the precise

determination of Febuxostat in blood plasma, especially in the context of bioavailability and bioequivalence studies.

## Keywords

Febuxostat, LC-MS, Pharmaceutical Analysis, Gout, Validation methods, Bioequivalence, Bioavailability study.

### 1. Introduction

Hyperuricemia and gouty arthritis, persistent conditions throughout human history, have witnessed a transformative evolution in mechanistic comprehension owing to recent research endeavors [1]. Despite these advancements, therapeutic interventions remain constrained. Gao *et al.* stated that a pivotal development in addressing this lacuna materialized with the FDA's endorsement of Febuxostat (FBS) in 2009 managed gouty arthritis or hyperuricemia [2]. FBS, a 2-(3-cyano-4-isobutoxyphenyl)-4-methyl-1,3-thiazole-5-carboxylic acid, has established itself as a secure and efficient treatment [3]. However, prolonged studies continue regarding its extended impact and its comparative efficacy over other anti-gout modalities.

Diverse methodologies have been devised for FBS determination, encompassing spectrophotometric and liquid chromatography methodologies [4] (**Table 1**). Our primary focus centers on a pioneering Liquid Chromatography-Mass Spectrometry (LC-MS) methodology for FBS quantification of human blood plasma. This methodology distinguishes itself through its inherent simplicity, discerning selectivity, and careful utilization of human plasma volume (a mere 100 ml) [5]. Yiwen *et al.* mentioned that the associated reduction in sample collection per progressive unit enhanced feasibility and extreme significance in augmenting data granularity, a critical consideration in bioavailability and future

pharmacokinetic investigations [6]. The singular employment of one-step solid-phase extraction ensures improved recoveries and obviates potential interference emanating from endogenous and exogenous sources [7]. The judicious inclusion of an isotope-labeled compound as an internal standard extends precision and accuracy. Ding *et al.* observed in their studies that with a shortened total run time of 2.0 minutes, LC-MS methodology emerged as an appealing bioanalytical mode for FBS in bioavailability and imminent pharmacokinetic inquiries [8].

**Table 1.** Differences between Spectrophotometry and Liquid Chromatography [9]

Parameter	Spectrophotometric	Liquid Chromatography
Principle of Analysis	Measures the absorption or transmission of light by a substance at specific wavelengths	Separates the mixture and quantifies the components based on their interaction with the mobile and stationary phases, generating a chromatogram
Analytical Range	Suitable for analyzing a single analyte or a small group of closely related compounds	Extends broader versatility for analyzing complex mixtures and a wide range of compounds simultaneously
Sensitivity	High sensitivity, especially in specific wavelength ranges	Provides High sensitivity, and with the integration of mass spectrometry (LC-MS), it also determines the trace-level analysis
Selectivity	Relies on differences in absorbance spectra, creating it less selective for complex mixtures	Achieves high selectivity by using specific columns and mobile phases, allowing the separation of closely related compounds
Application	Quantitatively analyze specific compounds in solutions, such as determining concentrations of chromophores	Widely used for analyzing complex samples in various fields, including pharmaceuticals, environmental analysis, and biochemistry
Speed of Analysis	Faster and delivers quick results	The analysis will take time due to the separation process, but it offers superior resolution for complex mixtures
Detection Techniques	Primarily relies on absorbance or transmittance measurements	Coupled with various detectors, such as UV-Vis, fluorescence, or mass spectrometry, it enhances detection capabilities

## 2. Overview of Febuxostat

Febuxostat has emerged as an essential drug for hyperuricemia and gout treatment. This innovative medication, unlike traditional options like allopurinol, specifically targets xanthine oxidase (XO), which is liable for uric acid production [10]. This targeted approach offers several advantages. Cicero *et al.* stated that FBS boasts a unique ability to bind and inhibit both oxidized and reduced forms of XO [11]. This potent dual action significantly reduces uric acid production, leading to lower serum urate levels (sUA) and, consequently, improved management of gout symptoms. *In vitro* studies have convincingly demonstrated its efficacy, solidifying its potential as a promising alternative [12]. While its potential was evident, FBS faced heightened scrutiny due to increased focus on drug safety profiles. Despite this, its compelling clinical data convinced regulatory bodies, with the European Medicines Agency and the U.S. Food and Drug Administration approving it in 2008 and 2009, respectively [13]. This emphasizes its crucial role in modern therapeutic approaches for gout management.



However, research continues to optimize FBS effectiveness. Further studies into its bioavailability and bioequivalence are ongoing, aimed at ensuring consistent and reliable performance within different individuals. Dina *et al.* mentioned that FBSs' unique mechanism of action, coupled with its proven efficacy and safety profile, positions it as a crucial component in the evolving view of gout management [14]. Ongoing research promises further refinement, solidifying its role in offering patients a more effective and well-tolerated approach to managing this condition.

Beyond the primary compound, derivatives such as Febuxostat d9 and d7 have gained attention in pharmaceutical research. FBS d9 and FBS d7 are isotopically labeled compounds, providing valuable tools in analytical and pharmacokinetic studies (**Table 2**). Yichao Xu *et al.* detailed that introducing deuterium atoms at specific positions in these derivatives facilitated precise quantification and elucidation of metabolic pathways during pharmacological

investigations [15]. FBS d9 and d7 have been employed with advanced analytical techniques, including LC-MS, to enhance the sensitivity and accuracy of quantitative analyses in biological samples, contributing to a deeper understanding of the FBS pharmacokinetic profile [16]. The isotopic labeling of these derivatives delivers invaluable insights into the absorption, distribution, metabolism, and excretion of FBS, contributing to the refinement of therapeutic strategies and optimization of dosage regimens [14].

**Table 2.** Chemical Structure of Febuxostat and its derivatives, FBS- d7 and d9

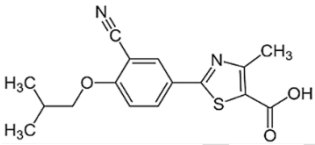
[<https://pubchem.ncbi.nlm.nih.gov/compound/134018>]

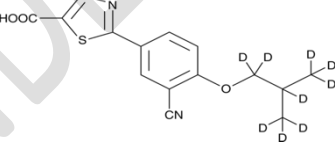
Drug	Chemical Structure	Chemical Name	M. Wt. (g/mol)
Febuxostat		2-(3-cyano-4-isobutoxyphenyl)-4-methyl-5-thiazolecarboxylic acid	316.4
Febuxostat - d7		2-[3-Cyano-4-(2-methylpropoxy)phenyl]-4-methyl-5-thiazolecarboxylic Acid-d7	323.4
Febuxostat - d9		2-[3-cyano-4-[1,1,2,3,3,3-hexadeuterio-2-(trideuteriomethyl)propoxy]phenyl]-4-methyl-1,3-thiazole-5-carboxylic acid	325.4

### 3. Importance of FBS Bioavailability and Bioequivalence Studies

In the realm of pharmaceuticals, bioavailability, and bioequivalence studies stand as pillars in ensuring drug efficiency and safety. For FBS, an essential drug in hyperuricemia management, unraveling its bioavailability and bioequivalence becomes imperative (**Figure 1**) [17]. This review explores the methodologies, especially focusing on the application of LC-

MS techniques in the determination of FBS in blood plasma [18]. With the keen emphasis on regulatory scrutiny for safety, understanding how LC-MS surpasses other techniques in specifying accurate drug measurement becomes crucial for advancing pharmacokinetic studies. The present review delves into the pivotal role of LC-MS as an analytical technique for elucidating the bioavailability and bioequivalence of FBS in blood plasma using FBS d9 and d7 and other drugs as internal standards (IS) [19]. By examining impurity profiles and the challenges posed by their complex pharmacokinetics, this review aims to contribute to the evolving view of pharmaceutical research and analysis.

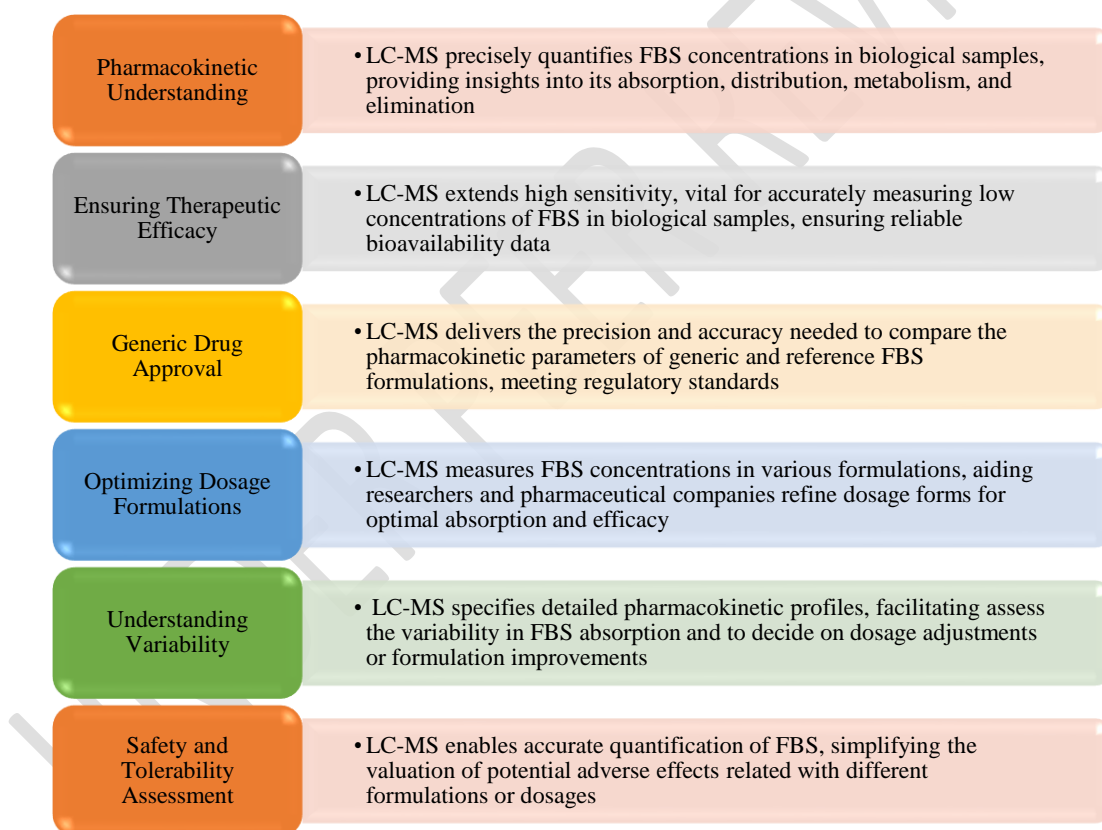

**Figure 1.** Requirements of Bioequivalence and Bioavailability Studies of Febuxostat by LC-

#### 4. Analytical Techniques in Pharmacokinetic Studies

Analytical techniques in pharmacokinetic studies encompass a spectrum of methodologies designed to elucidate a drug's behavior within the body. These are essential for comprehending how drugs interact with the body over time. Some of the commonly used techniques include Gas Chromatography (GC), Mass Spectrometry (MS), High-Performance Liquid Chromatography (HPLC), and more recently, advanced hyphenated methods such as LC-MS (**Table 3**) [20]. HPLC is widely utilized for its capacity to separate components in liquid samples with high sensitivity. Kamel B *et al.* specified that LC-MS combines separation with mass analysis, offering specificity and the ability to identify compounds in complex matrices [21]. GC-MS is ideal for analyzing volatile compounds in environmental and forensics fields. Hybrid techniques, such as LC-MS/MS, integrate multiple methods for enhanced capabilities [22]. Each method has its strengths, addressing specific analytical challenges in drug quantification, impurity profiling, and metabolite identification. Researchers choose techniques based on drug characteristics, often combining methods for a comprehensive pharmacokinetic understanding.

**Table 3.** Different Analytical Techniques Used in Pharmaceutical Drug Analysis

Parameter	GC	MS	HPLC	LC-MS
Compound Compatibility	Less commonly applied	Not much applied	Deals with liquid samples and compounds requiring high-resolution separation	Analyze a broad range of compounds, like polar and non-volatile, found in drug formulations
Sample Types	Volatile Drugs	Used only when coupled with LC	Drug formulations	Pharmaceutical drugs, metabolites, and biomarkers with diverse chemical properties

Sensitivity & Selectivity	Less sensitive due to its limited use in volatile compounds	Exceptionally sensitive to delivering structural information, and valuable for pharmaceutical R&D	Provides high sensitivity & selectivity to meet pharmaceutical quality control and impurity profiling	Delivers high sensitivity & selectivity vital for detecting low concentrations of drugs and their metabolites in complex matrices
Versatility	Less versatile in pharmaceuticals with specific analysis	Beneficial for in-depth structural characterization of pharmaceutical compounds	Commonly employed for routine pharmaceutical analysis, particularly in QC	Adaptable for analyzing pharmaceuticals, handling a wide variety of drug compounds
Quantitative Analysis	Limited	Potent device for accurate quantitative analysis	Routinely used for the precise determination of drug concentrations	Extensively used for drugs and their metabolites analysis, providing accurate and reliable results

#### 4.1 Significance of Accurate Drug Measurement

Accurate drug measurement is paramount in pharmacokinetic studies, serving as a cornerstone for reliable data vital in drug development and clinical applications. The precision of these measurements holds substantial influence over the assessment of crucial pharmacokinetic parameters, with absorption, distribution, metabolism, and excretion (ADME) of pharmaceutical compounds [23]. Any inaccuracies in drug measurement can introduce biases, leading to distorted pharmacokinetic profiles that may compromise the safety and efficacy of the drug. Sharma S *et al.* observed that analytical techniques played a pivotal role in confirming the accuracy of drug measurements by providing high sensitivity, selectivity, and the capacity to separate complex mixtures of drugs and metabolites [24]. This precision is essential in establishing a robust foundation for pharmacokinetic studies, contributing significantly to the reliability of data that informs clinical decision-making. As regulatory standards become more stringent, the emphasis on accurate drug measurement grows, reinforcing its pivotal role in shaping the pharmaceutical background.

## 5. Liquid Chromatography: An Overview

Liquid Chromatography is a fundamental analytical technique crucial for separating and quantifying components within mixtures. The technique relies on the differential partitioning of a sample between a mobile liquid phase and a stationary phase, leading to the separation of individual components based on their chemical properties [25]. As per a study by Faraz Rahimi *et al.*, LC comprehends various modes, including HPLC and Ultra-High-Performance Liquid Chromatography (UHPLC), allowing customization of column type, the composition of mobile phase, and detection methods, which is a requisite tool in the pharmaceutical analysis [26].

At the core of LC lies a dynamic process that reveals the secrets of mixtures. The technique involves sample injection into the mobile phase stream, followed by column chromatography. The mobile phase transports the sample over a column packed with the stationary phase [27]. Different molecules interact uniquely with the stationary phase, leading to varied retention times. As the separated components emerge, a detector measures their presence and amount, translating the information into a chromatogram (**Figure 2**). This discloses the identity and quantity of each component in the mixture [28]. LCs' versatility is further highlighted by its applications, ranging from pharmaceuticals, food and beverage analysis, environmental analysis, and biotechnology, to forensic science [29].

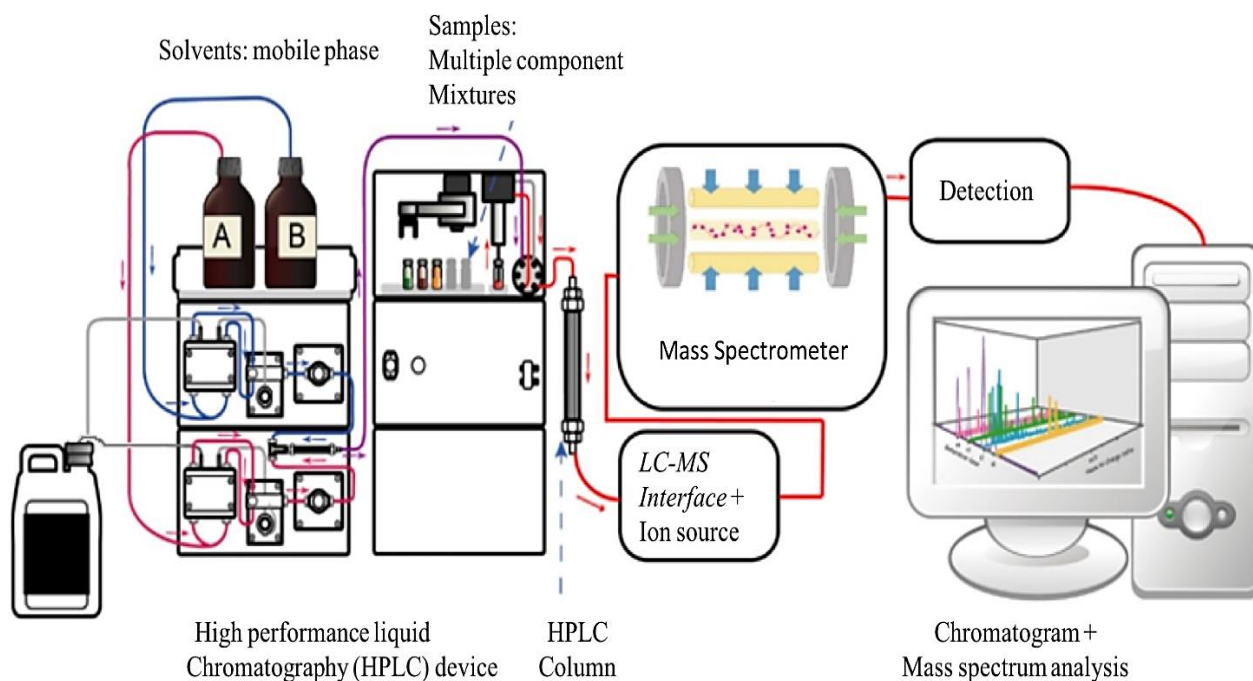

**Figure 2.** Schematic representation of a Liquid Chromatography Mass Spectrometer. [Credit: Cwszot, Dagui1929, CasJu, and YassineMrabet, reproduced under the [Creative Commons CC0 1.0 Universal Public Domain Dedication](https://creativecommons.org/licenses/by/4.0/) license.]

### 5.1 Advantages of LC in Pharmaceutical Analysis

LC occupies a central role in pharmaceutical analysis and its strength lies in its exceptional sensitivity, allowing the detection of minute drug quantities and impurities within complex mixtures. Srinivas B *et al.* stated that LC is a vital method for ensuring safety and efficacy, as even trace amounts can have a substantial impact [30]. Furthermore, LC stands out in separating individual components with remarkable precision (**Figure 3**). This meticulous separation enables accurate identification and quantification of each element, regardless of their similarities [31]. Additionally, LC demonstrates remarkable flexibility, analyzing a wide range of molecules, from small drugs to large proteins. This adaptability makes it an indispensable tool for both research and quality control.

Beyond its core strengths, LC offers several other advantages [32].

- *Precise measurements*: LC delivers accurate quantitative results, critical for ensuring consistent drug dosages and safety profiles.
- *Broad applicability*: It effectively analyzes diverse analytes, including hydrophobic and hydrophilic compounds, covering the varied chemical properties of drug molecules.
- *High-throughput analysis*: Modern automated systems process large batches of samples efficiently, crucial for high-volume pharmaceutical testing.
- *Diverse detection methods*: Compatibility with UV-Vis, fluorescence, and mass spectrometry detectors enhances analysis and characterization of pharmaceutical compounds.
- *Regulatory compliance*: Widely accepted methods ensure results comply with pharmaceutical standards, facilitating new drug approval processes.

LCs' unique combination of sensitivity, precision, versatility, and efficiency firmly establishes it as the go-to technique for pharmaceutical analysis. Its ability to provide accurate and reliable data across diverse sample types makes it an invaluable asset in validating the safety, efficiency, and superiority of pharmaceutical products.

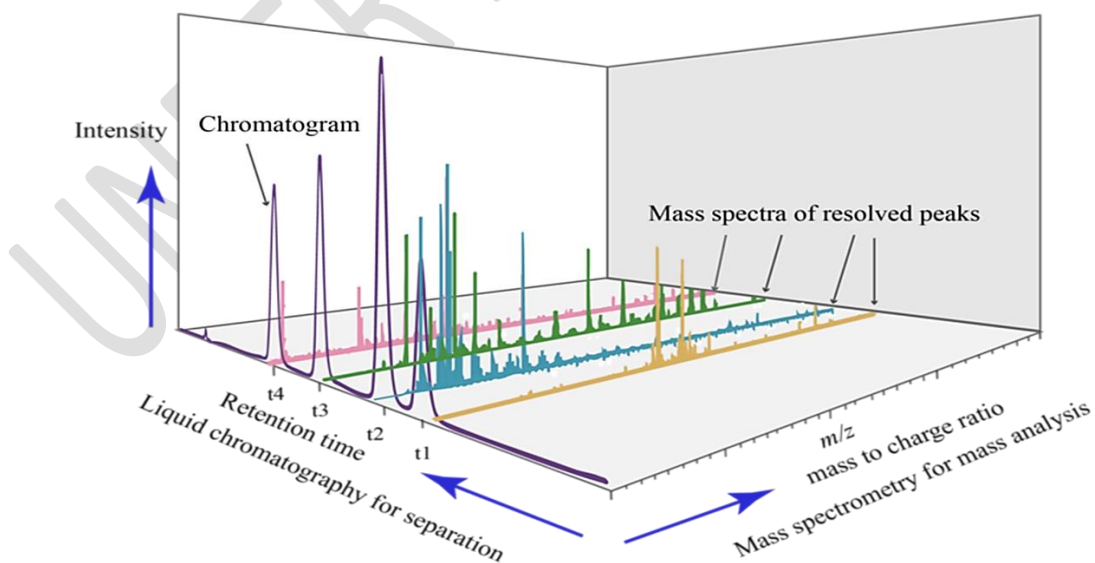

**Figure 3.** Example of the outline of LC-MS analysis. [Credit: Daniel Norena-Caro, reproduced under the [Creative Commons CC0 1.0 Universal Public Domain Dedication](https://creativecommons.org/licenses/by/4.0/) license.]

## 6. Febuxostat: Properties and Importance in Clinical Studies of Gout

FBS claims a distinct molecular structure critical to its pharmacological actions. Bin Fan *et al.* mentioned that the nonpurine selective inhibitor, FBS, helps to manage hyperuricemia associated with gout [33]. Excess uric acid in joints causes Gout, an inflammatory condition. FBS molecule's core structure includes a 1,3-thiazole monocarboxylic acid core, a 3-cyano-4-(2-methylpropoxy) phenyl substituent, and nitrogen and sulphur atoms. These attributes contribute to its stability, binding affinity to XO, and overall pharmacological profile. Arrigo *et al.* stated that FBSs' unique properties, such as potent XO inhibition, oral availability, selectivity, and prolonged action, make them a valued therapeutic option [34]. Clinical studies focus on the efficacy and safety of FBS in gout management. Ruixia Sun specified that FBS effectively reduces the frequency and severity of flares, diminishes urate calculi, and maintains serum uric acid levels below recommended levels [35]. FBS demonstrates superior tolerability and safety, with fewer side effects compared to allopurinol [33]. Despite these, FBSs' impact on gout treatment positions it as a key player in clinical practice, for improved joint health and a better quality of life for patients.

### 6.1 Role of FBS in Gout Management

Gout, inflammatory arthritis formed in joints, has found a powerful connection with FBS (**Figure 4**). Unlike traditional medications that manage symptoms, Kraev KI *et al.* in their research found that FBS challenges the root cause by targeting and inhibiting XO, the enzyme responsible for uric acid production [36]. This dual action against the oxidized and reduced

forms of XO effectively lowers serum urate (sUA) levels, significantly reducing the risk of gout flares and promoting joint health [37]. Clinical studies have validated its efficacy in this regard, showcasing its ability to not only decrease the frequency and severity of flares but also maintain healthy uric acid levels for extended periods. Gout, being a crystal-induced disease, requires addressing the source of the crystals: uric acid [38]. Santwona Dash *et al.* also detailed that by inhibiting XO and suppressing uric acid production, FBS directly targets the root cause, offering a more comprehensive solution than simply managing symptoms [39]. Additionally, its safety profile and tolerability hold significant value in regulatory scrutiny. Understanding FBSs' unique properties not only sheds light on their effectiveness in managing gout but also paves the way for further targeted research and advancements in gout treatment [40].



**Figure 4.** Foot affected by Gout exposing swelling, joint rigidity, and pain around the joint.

[Credit- Creative Commons Attribution-Share Alike 4.0 International

<http://www.scientificanimations.com/wiki-images/>]

## 7. Need for High-Performance Analytical Techniques

Analyzing FBS presents a set of challenges that necessitate the application of high-performance analytical techniques. The compound's intricate molecular structure, as an XO inhibitor, requires careful study [41]. Traditional analytical methods may struggle to provide the necessary resolution and sensitivity due to the complexity of Febuxostats' pharmacokinetics. The structural nuances, coupled with potential interference from

endogenous compounds, demand advanced techniques that can direct these challenges. A recent study by Tingting Wang *et al.* specified that high-performance analytical methods, particularly LC-MS, emerge as an essential tool to overcome these hurdles, ensuring accurate quantification and reliable pharmacokinetic data (**Table 4**) [42].

**Table 4.** Difference and prominence between LC-MS and Traditional methods

Parameter	Traditional Method	LC-MS
Sensitivity & Specificity	Often lack the sensitivity and specificity leading to potential challenges in detecting low-concentration analytes	Delivers higher sensitivity and specificity due to the combination of LC for separation and MS for precise detection
Structural Information	Don't provide detailed structural information, causing compound identification challenges	Extends structural information through mass analysis, aiding in the compound identification based on their mass-to-charge ratios
Multiple Analyte Detection	Often involve separate assays for each analyte, leading to longer analysis times and increased resources	Enables concurrent detection of multiple analytes in a single run, improving efficiency
Interference & Matrix Effects	Have challenges with interference and matrix effects, especially in complex sample matrices	Mitigate interference from matrix components through selective detection with the use of internal standards
Quantitative Accuracy	Relies on external calibration, potentially leading to variations in accuracy	Allows the use of internal standards, enhancing accuracy in quantification
Lower Detection Limits	Have higher LOD and LOQ, limiting their utility for trace-level analysis	Attains lower LOD and Quantitation LOQ, enabling the detection of compounds at very low concentrations
Regulatory Compliance	Require additional validation steps to meet regulatory standards	Mostly preferred in pharmaceutical and clinical research for its ability to meet stringent regulatory requirements

### 7.1 Importance of Accuracy in Bioavailability Studies

The accuracy of bioavailability studies is paramount in understanding the therapeutic profile of FBS. Bioavailability is the portion of a directed dose that reaches the systemic circulation and is a crucial parameter influencing a drug's effectiveness [43]. For FBS, precision in bioavailability measurement becomes imperative. Greco V *et al.* observed that the inaccuracies in quantifying FBS levels in blood plasma can lead to misguided assessments of

its absorption, distribution, and elimination [44]. High-performance analytical techniques, particularly those offering sensitivity, specificity, and automated exact mass measurement like LC-MS, play a pivotal role in ensuring the accuracy required for robust bioavailability studies [45]. The reliability of these studies is paramount in shaping dosage recommendations, optimizing therapeutic outcomes, and meeting regulatory standards in the development of FBS as a key player in gout management.

## **8. Liquid Chromatography in Pharmaceutical Analysis**

LC is a vital technique in pharmaceutical analysis, rooted in principles that support its widespread application. The method relies on the differential partitioning of a sample between a mobile liquid phase and a stationary phase [46]. The sample is injected into the mobile phase, typically a liquid solvent, and passes through a column containing the stationary phase. Components in the sample interact differently with the stationary phase, leading to their separation based on factors such as polarity, size, and affinity. Leonardo Perez *et al.* indicated that the key variations, including HPLC and UHPLC, enhance speed and resolution, focusing on LC as a versatile and powerful tool in pharmaceutical analysis [47].

### **8.1 Application in Drug Quantification**

LCs' application in drug quantification is integral to pharmaceutical analysis, particularly in pharmacokinetic studies. Hector *et al.* indicated that LCs' ability to precisely separate and quantify individual components within a complex mixture shows it is well-suited for determining drug concentrations in biological samples [48]. In drug quantification, a sample containing the drug of interest is introduced into the LC, and the detector records the signals as separated components elute from the column [32]. By comparing these signals to those of known standards, the drug concentration in the sample can be accurately verified. The

techniques' sensitivity, selectivity, and adaptability to various detection methods, such as UV or MS, enhance their utility in drug quantification [49]. Deschamps E *et al.* cited that LC played a crucial role in ensuring the precision and reliability required for accurate drug quantification, contributing extensively to the advancement of pharmaceutical research and analysis [50].

## 8.2 Methodology: Liquid Chromatography for Febuxostat Analysis

Choosing the appropriate LC technique is a critical step in ensuring the accurate and reliable analysis of febuxostat. HPLC and UHPLC are common choices. The decision is often guided by factors such as the required resolution, sensitivity, and speed of analysis. UHPLC, with its higher pressure and smaller particle sizes, allows for faster separations and improved resolution compared to traditional HPLC [51]. The selection depends on the specific demands of the analysis, emphasizing the need for optimal separation and quantification of FBS from complex matrices.

### 8.2.1 Sample Preparation

For analyzing FBS, sample preparation is a crucial step in LC, notably impacting the accuracy and sensitivity of the analytical method. In the context of biological samples, the Shimaa *et al.* study detected that the blood plasma required meticulous preparation to eliminate potential interferences and enhance the purity of the analyte before chromatographic analysis [52]. Commonly employed techniques for extracting FBS from the blood plasma include protein precipitation or liquid-liquid extraction [53].

In the protein precipitation method, blood samples are collected, and plasma is separated using centrifugation. Internal standards were added to ensure accuracy. Jiawen Lyu *et al.* cited that protein precipitation was induced by introducing a protein-denaturing solvent, followed by centrifugation to separate proteins from the supernatant [54]. The resulting

supernatant, containing the target analytes, was then transferred to a new vial. After undergoing evaporation and reconstitution, the prepared sample is ready for injection into the LC-MS system for analysis [55].

On the other hand, the liquid-liquid extraction method involves mixing plasma with an organic solvent to facilitate extraction. After the organic phase containing analytes was separated, it was collected, subjected to evaporation, modified, and then infused into the LC-MS system. The choice between these sample preparation methods depends on various factors, including the specific analytical method, the nature of the sample matrix, and the desired sensitivity [56]. Optimization of the sample preparation process is crucial to ensure accurate and reliable results in FBS analysis from blood plasma.

### 8.2.2 Chromatographic Conditions

For chromatographic analysis of FBS, the selection of chromatographic conditions is pivotal for the success of the technique. Key factors, such as the choice of stationary and mobile phases, significantly influence the separation and detection of the target compound. Typically, a reversed-phase column is preferred for FBS analysis due to its compatibility with polar compounds [57]. The optimization of the mobile phase composition, flow rate, and detection wavelength is crucial to achieving maximum sensitivity and resolution in the chromatographic separation. Thorough consideration and fine-tuning of these parameters contribute to the progress of a robust and consistent LC technique for FBS analysis (**Table 5**). This optimized method ensures accurate and precise data, which is essential for conducting pharmacokinetic studies. Patel B *et al.* specified that by providing a well-defined separation of FBS and other components in the sample matrix, these chromatographic conditions contributed to the overall success of the analytical method in pharmaceutical research and development [58].

**Table 5.** Chromatographic conditions for the determination of FBS [53, 59-62]

Drugs	Matrix	Stationary Phase	Mobile Phase	Analytical Wavelength (nm)
FBS	Human Plasma	Phenomenex Luna C18	Acetonitrile: water, 60:40, v:v, 0.032% glacial acetic acid	380
FBS	Human Plasma	Inertsil Symmetry C18 column	Methanol/1% formic acid (80:20; v/v)	210
FBS	Human Plasma	Bondapak C18	Acetonitrile and 0.5% aqueous phosphoric acid (52: 48, v/v)	315
FBS	Human Plasma	Nucleosil C18	10 mM ammonium acetate buffer (buffer of pH 4.0 adjusted with 0.2% triethyl amine) and acetonitrile in the ratio (15: 85, v/v)	275
FBS	Human Plasma	Purospher® RP-18	Trifluoroacetic acid (0.1%) in water and acetonitrile in a ratio of 42:58 v/v	230

## 9. Validation of the Analytical Method

Method validation is a crucial step in establishing the reliability and robustness of an analytical procedure, ensuring that the results generated are accurate, reproducible, and appropriate for the intended purpose [63]. In the context of LC for FBS analysis, method validation is paramount for confirming the appropriateness of the technique for its proposed claim in pharmacokinetic studies [64]. Validated methods introduce confidence in the accuracy of the data, contributing to the overall quality and credibility of the analytical results.

### 9.1 Parameters and Criteria for Validation

During the validation of an analytical method for FBS analysis, several key parameters and criteria play a crucial role in ensuring the methods' accuracy and reliability. Ramanlal *et al.* stated that one fundamental parameter was specificity, which evaluated the methods' ability to accurately and selectively measure FBS in the presence of potential impurities or matrix components [65]. Ensuring specificity is essential to guarantee that the detected signals solely originate from the analyte of interest. Precision assesses the degree of repeatability and

reproducibility of the method. Precision is evaluated through measures such as intra-day and inter-day precision, offering insights into consistent results under varying conditions [66].

Accuracy measures the closeness of calculated values to the true values and is often determined through recovery studies. Kamel B *et al.* cited that these studies involved comparing the measured concentration to the known concentration of FBS in spiked samples, establishing the accuracy of the method [21]. The linearity of the method is assessed to determine its ability to provide results that are directly proportional to the concentration of FBS in the sample. Calibration curves constructed over a range of concentrations help evaluate and establish the linearity of the analytical method. Parameters such as Limit of Detection (LOD) and Limit of Quantitation (LOQ) signify the lowest concentrations at which FBS can reliably detect and quantify, respectively. These parameters define the sensitivity of the method, crucial for pharmacokinetic studies [17]. Stability studies are conducted to assess the robustness of the method over time, including the stability of FBS in solution and the stability of analytical solutions under various storage conditions [67]. Diligently addressing these parameters during validation provides a comprehensive understanding of the analytical methods' competencies, establishing their aptness for pharmacokinetic studies involving FBS.

## 9.2 Clinical Validation Method in Healthy Subjects

This review was focused on studying to assess the bioavailability of Febuxostat in human blood plasma following oral administration. Aaron *et al.* developed a highly sensitive liquid chromatography-tandem mass spectrometry (LC-MS/MS) method, featuring a 10-fold higher sensitivity, and employed liquid-liquid extraction for sample preparation [68]. FBS d7 & FBS d9 and a few other drugs were utilized as internal standards to enhance accuracy and mitigate matrix effects. Babu *et al.* stated that the validated method demonstrated exceptional sensitivity with an LLOQ with a minimum of 1 ng/mL, successfully quantifying FBS

concentrations [69]. The validation of FBS on precision, accuracy, recovery, and stability study results supported a comprehensive clinical pharmacokinetic study, contributing valuable data for dosage recommendations and therapeutic optimization (**Table 6, 7**). The chromatograms of the studied Blank and the FBS standard are displayed in **Figures 5 & 6**, respectively [78].

### 9.3 Impurity Profile Determination using LC-MS Quadrupole Time-of-Flight (Q-TOF)

The impurity study of FBS Active Pharmaceutical Ingredient (API) involves a thorough examination of impurities within the drug substance, including an assessment of carryover impurity from intermediate stages and raw materials [79]. To achieve this, an LC-MS Q-TOF instrument was employed for impurity profiling, providing automated exact mass measurement and structural confirmation through infrared (IR), nuclear magnetic resonance (NMR), and mass analysis following isolation [80, 81]. The Q-TOF instrument delivers high-quality data, offering insights into the elemental composition and structural characteristics of impurities. Mustakhusen *et al.* cited that this detailed impurity profile is of paramount importance for regulatory compliance, ensuring adherence to safety standards, and maintaining the efficacy of the FBS API [82]. The overall impurity study involves a meticulous process starting with method development, utilizing techniques like HPLC or LC-MS for sensitive impurity detection [83, 84]. Sample preparation ensures representative drug substance samples, and chromatographic analysis, often with LC-MS, is conducted for the separation, identification, and quantification of impurities. Techniques like mass spectrometry, NMR spectroscopy, and IR spectroscopy contribute to structural characterization. Margaret *et al.* mentioned that validation of the method is crucial for regulatory compliance, culminating in the identification, quantification, and reporting of impurities, ensuring the pharmaceutical product's safety, efficacy, and adherence to quality standards [85].

## 10. Future Perspectives and Innovations in LC

Ongoing research is eagerly exploring potential breakthroughs in LC, primarily targeting advancements in column technology. Novel stationary phases and column designs, such as monolithic columns and superficially porous particles, are under study [86]. These innovations aim to elevate separation efficiency, increase analysis speed, and enhance selectivity, thereby pushing the boundaries of what LC can achieve in drug analysis. Concurrently, a study by Deyber *et al.* quoted an outstanding trend gaining momentum involving the miniaturization and incorporation of microfluidics into LC systems [87]. This shift towards micro-scale LC systems offers compelling advantages, including reduced solvent consumption, heightened sensitivity, and the prospect of conducting high-throughput analyses.

Also, the future view of LC holds exciting prospects in terms of hyphenation with advanced detection techniques [88]. Integrating LC with cutting-edge methods such as capillary electrophoresis, ion mobility spectrometry, and high-resolution MS presents a promising avenue for achieving unparalleled sensitivity, specificity, and comprehensive characterization of complex drug samples [89]. Besides, automation is anticipated for the potential emergence of high-throughput platforms in LC. Met Han *et al.* specified that the automated processes encompassing sample preparation, injection, and data analysis were balanced to contribute significantly to the efficiency, reproducibility, and overall advancement of drug analysis methodologies [90].

## 11. Emerging Technologies in Pharmaceutical Research

Pharmaceutical research is undergoing a profound transformation, marked by several key trends and innovations. Artificial Intelligence (AI) is at the forefront, leveraging machine learning and deep learning for transformative impacts on drug discovery processes [91]. A

study by Sarkar *et al.* mentioned that predictive modeling, virtual screening, and the analysis of intricate biological data are domains witnessing significant advancements, showcasing the potential of AI to revolutionize the entire drug development pipeline [92]. Further, the pharmaceutical industry is experiencing a shift towards continuous manufacturing processes, gaining momentum due to their potential for improved efficiency, reduced costs, and heightened control over production. Innovations in drug delivery systems are also unfolding, with nanotechnology taking center stage. Nano-sized carriers are demonstrating the ability to enhance drug solubility, improve bioavailability, and enable targeted delivery, offering the potential for more effective and less toxic treatments [93]. In the field of clinical trials, the application of blockchain technology is emerging as a disruptive force. Aithal *et al.* specified that blockchain brings transparency, security, and data integrity to clinical trials, with smart contracts and decentralized platforms updating trial processes and data management [94]. These advancements, linked with the continuous evolution of LC and the integration of emerging technologies, are collectively shaping a dynamic future for pharmaceutical research and analysis.

## 12. Conclusion

In the realm of pharmaceutical analysis, LC-MS reigns supreme, especially when delving into the intricate pharmacokinetics of drugs like Febuxostat. Its versatility offers a unique collection of advantages. This comprehensive review of LC-MSs' high sensitivity, selectivity, and customizable conditions makes them indispensable for quantifying Febuxostat and other pharmaceutical drugs with precision, generating reliable pharmacokinetic data crucial for understanding drug behavior. FBSs' adaptability to various detection methods, robust sample preparation techniques, and advancements in column technologies further solidify its lead. Beyond separation, LC-MS significantly contributes to the accuracy and

specificity demanded in pharmacokinetic studies, with reliable validation protocols ensuring data integrity and regulatory compliance. LC-MSs' proven track record in providing impurity profiles, simultaneous metabolite determination, and successful bioavailability studies position it as a cornerstone for future endeavors. Thus, LC-MS's superiority in Febuxostat analysis set the stage for a future where pharmacokinetic studies become insightful, efficient, and transformative, shaping the future of pharmaceutical research.

UNDER PEER REVIEW

**Table 6.** HPLC method for the determination of FBS & FBS- d7 & d9 in Human Blood Plasma [69-74]

Drug	Matrix	Stationary Phase	Mobile Phase at Flow Rate (FR)	Internal Standard	Detection	Sensitivity					
						Parameters		Precision (%)	Accuracy (%)	Recovery (%)	Stability (ng/ml)
						LOD (µg/ml)	LOQ (ng/ml)				
FBS	Human Plasma	Capcell Pak C18	Acetonitrile–5mM ammonium acetate–formic acid (85:15:0.015, v/v/v) at 0.6 mL/min	FBS-d7	LC-MS/MS	0.01-5	10	4.2	105	95.9	18.9-21.8
FBS	Human Plasma	Zorbax SB-C18	5mM ammonium formate and acetonitrile (40:60, v/v) at 0.5mL/min	FBS-d7	LC-MS/MS	0.01-6	1.1	7.69	110	82.7	3.13-3.24
FBS	Human Plasma	Ascentis Express C18	10 mM Ammonium formate: Acetonitrile (20:80 v/v) at 0.8 mL/min	FBS-d7	LC-MS/MS	0.01-8	1	8.44	103.19	81.59	3.03-3.11
FBS	Human Plasma	Hypersil Gold-C18	Mobile phase A [Water (0.1% formic acid)], and mobile phase B [acetonitrile (0.1% formic acid)] at 0.3 mL/min	FBS-d9	LC-MS	0.01-8	10	8.68	104.86	112.06	29.80-31.80

FBS	Human Plasma	Zorbax Eclipse XDB, C8	Acetonitrile and HPLC grade water in the ratio of (60:40 v/v)	FBS-d9	LC-MS	0.02-10	20.13	5.69	100.1	76.56	58.44-62.68
FBS	Human Plasma	Kromasil 100-5C18	5mM ammonium formate and acetonitrile (20:80, v/v) at 1.0 mL/min	FBS-d9	LC-MS/MS	0.015-8	15.1	4.71	105	80.1	45.8-49.2

---

UNDER PEER REVIEW

**Table 7.** HPLC method for the determination of FBS & a few drugs as IS in Human Blood Plasma [60, 75-77]

Drug	Matrix	Stationary Phase	Mobile Phase at Flow Rate (FR)	Internal Standard	Detection	Sensitivity		Precision (%)	Accuracy (%)	Recovery (%)	Stability (ng/ml)
						Parameters					
						LOD (µg/ml)	LOQ (ng/ml)				
FBS	Human Plasma	ZORBAX SB-C18	0.2% formic acid (A) and acetonitrile (B) [0–8.6 min, 28%B; 8.6–8.8 min, 28–100% B; 8.8–10.7 min, 100% B; 10.7–11 min, 100–28% B; 11–12.5 min, 28% B} at 0.08mL/min Methanol: 10 mM ammonium acetate: glacial acetic acid (70:30:0.01, v/v/v) at 0.8 mL/min	Losartan Potassium	LC-MS/MS	0.1-200	10	12.2	5.1	87.1-98.6	-
FBS	Human Plasma	Hypurity C18	Acetonitrile and 0.5% aqueous phosphoric acid (pH 3) (52: 48, v/v)	Indomethacin	LC-MS/MS	0.05-6	50	7.1	105.6	85.1	41.0-46.9
FBS	Human Plasma	Bondapack C18	Acetonitrile and 0.5% aqueous phosphoric acid (pH 3) (52: 48, v/v)	Ketoprofen	LC-MS/MS	0.05-5	50	5.28	103.78	77.56	144-151

FBS	Human Plasma	BEH C18	0.1% formic acid and acetonitrile (25:75; v/v) at 0.5mL/min	Trandolapril	UPLC	0.075-12	75	6.96	5.5	106.5	85.5-137.87
-----	-----------------	---------	---	--------------	------	----------	----	------	-----	-------	-------------

---

UNDER PEER REVIEW

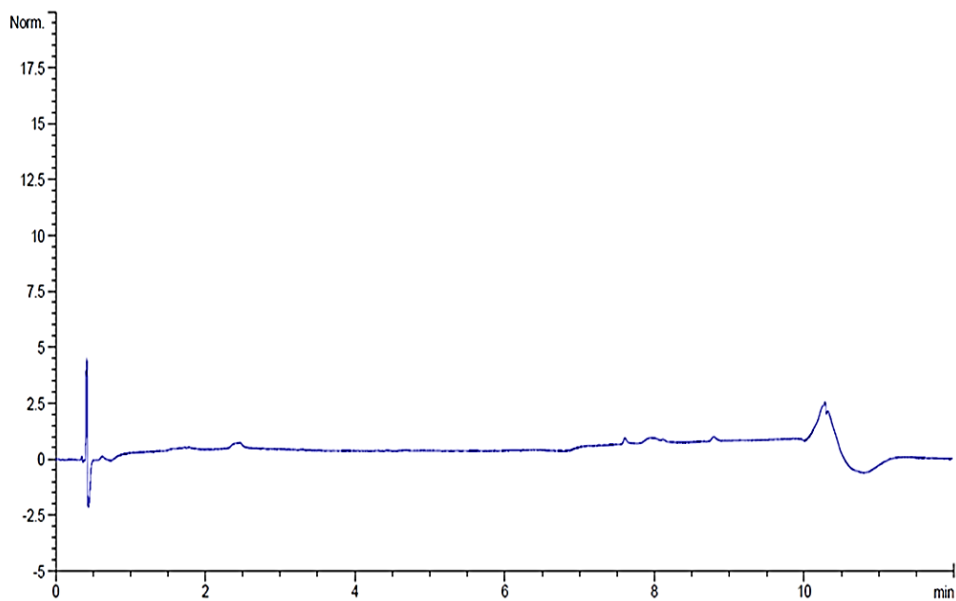

**Figure 5.** Chromatograms of the Blank Sample [78]

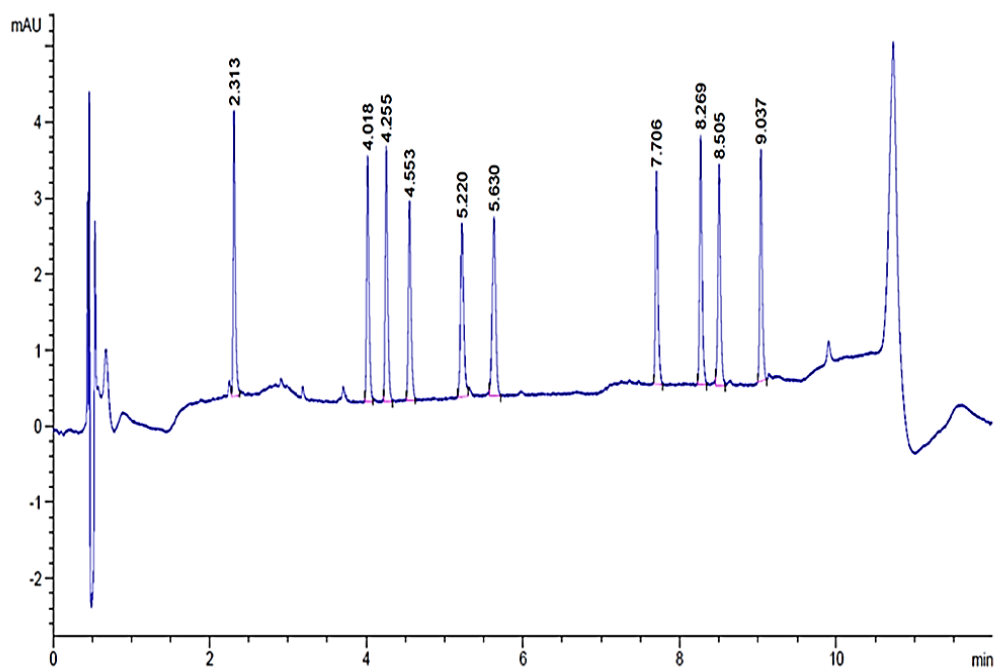

**Figure 6.** Chromatograms of the Febuxostat Standard [78]

## REFERENCES

1. Zhongwei Xu, Beyond Conventional Care: Developing Novel Therapeutic Approaches to Combat Arthritis, ProQuest Dissertations Publishing, **2023**, 30962423.  
<https://www.proquest.com/openview/5c374df1f32fa1ab6573f82847d917ea/1?pq-origsite=gscholar&cbl=2026366&diss=y>
2. Gao Tianshu, Xu Jin, Xiao Yuxiao, Li Jiaqi, Hu Weifeng, Su Xiaoyu, Shen Xudong, Yu Wan, Chen Zhen, Huang Baosheng, Li Honglei, Wang Xing, Therapeutic effects and mechanisms of N-(9,10-anthraquinone-2-ylcarbonyl) xanthine oxidase inhibitors on hyperuricemia, *Frontiers in Pharmacology*, **2022**, *13*.
3. D.M. Darandale, K.B. Erande, S.R. Tambe, R.S. Bhamber, Development and Validation of RP-HPLC Method for the Determination of Febuxostat in Bulk and Pharmaceutical Dosage Form, *Indian Journals*, **2017**, *10*, 6, 713-718.
4. Raj Kumar, Gaurav Joshi, Harveen Kler, Sourav Kalra, Manpreet Kaur, Ramandeep Arya, Toward an Understanding of Structural Insights of Xanthine and Aldehyde Oxidases: An Overview of their Inhibitors and Role in Various Diseases, *Medical Research Reviews*, **2018**, *38*, 4, 1073-1125.
5. Russell P. Grant, Brian A. Rappold, Development and Validation of Small Molecule Analytes by Liquid Chromatography-Tandem Mass Spectrometry, *Principles and Applications of Clinical Mass Spectrometry*, **2018**, 115-179.
6. Yiwen Ma, Kaifeng Guo, Mian Wu, Xiaoting Chen, Shen Qu, Haibing Chen, Serum Metabolome Analysis by Liquid Chromatography–mass Spectrometry Reveals Differences between Asymptomatic Hyperuricemia and Gout, Preprint, **2020**.  
<https://doi.org/10.21203/rs.3.rs-93712/v1>

7. Oriana G. Chavez-Pineda, Roberto Rodriguez-Moncayo, Diana F. Cedillo-Alcantar, Pablo E. Guevara-Pantoja, Josue U. Amador-Hernandez, Jose L. Garcia-Cordero, Microfluidic systems for the analysis of blood-derived molecular biomarkers, *Electrophoresis*, **2022**, *43*, (16-17), 1667-1700.
8. Ruilin Ding, Longxia Chen, Xinghai Li, Tengqiong Xiong, Hong Chen, Xiaojing Hu, Yun Li, Yi Zhou, Kezhi Liu, Jianhong Wu, Feng Jiang, Qing Peng, A Phase I Study to Evaluate the Pharmacokinetic Drug-Drug Interaction of HP501, Febuxostat, and Colchicine in Male Chinese Patients with Hyperuricemia, *Clin Drug Investig*, **2023**, *43*, 401–411.  
<https://doi.org/10.1007/s40261-023-01274-7>
9. Kalyani A. Gudadhe, Mukund G. Tawar, Development and Validation of Analytical Instrumental Method for Pharmaceutical Products, *Am. J. Pharm Health Res*, **2019**, *7*, 4, ISSN: 2321-3647.
10. Heba Selim Elshair, Yasser Ahmed Nienaa, Rana Ibrahim Koreen, Noha M Elkholy, Renoprotective Effect of Febuxostat Compared with Allopurinol in Hyperuricemic Chronic Kidney Disease Patients Stage 3 and 4, *Medicine Updates*, **2022**, *9*, 9, 71-105.
11. A.F.G. Cicero, F. Fogacci, M. Kuwabara, C. Borghi, Therapeutic Strategies for the Treatment of Chronic Hyperuricemia: An Evidence-Based Update, *Medicina*, **2021**, *57*, 1, 58. <https://doi.org/10.3390/medicina57010058>
12. Yu B. Belousov, Seminar "Gout: Status of the Problem", **2020**,  
<https://studyboom.ru/en/ingibitory-ksantinoksidazy-seminar-podagra-sostoyanie-problemy/>
13. M.E. Gherghina, I. Peride, M. Tiglis, T.P. Neagu, A. Niculae, I.A. Checherita, Uric Acid and Oxidative Stress—Relationship with Cardiovascular, Metabolic, and Renal Impairment, *International Journal of Molecular Sciences*, **2022**, *23*, 6, 3188.  
<https://doi.org/10.3390/ijms23063188>

14. Dina S Ghallab, Eman Shawky, Ali M. Metwally, Ismail Celik, Reham S. Ibrahim, Mohamed M. Mohyeldin, Integrated in silico – *in vitro* strategy for the discovery of potential xanthine oxidase inhibitors from Egyptian propolis and their synergistic effect with allopurinol and febuxostat, *RSC Adv*, **2022**, *12*, 5, 2843-2872.
15. Yichao Xu, Jinliang Chen, Dandan Yang, Yin Hu, Xinhua Hu, Bo Jiang, Zourong Ruan, Honggang Lou, Development of LC-MS/MS determination method and backpropagation artificial neural networks pharmacokinetic model of febuxostat in healthy subjects, *J Clin Pharm Ther*, **2021**, *46*, 333–342. <https://doi.org/10.1111/jcpt.13285>
16. Xiangling Feng, Yan Cao, Yufeng Ding, Heng Zheng, Development and validation for the quantitative determination of xanthine oxidoreductase inhibitor topiroxostat by LC-MS/MS and its clinico-pharmacokinetic study, *Journal of Pharmaceutical and Biomedical Analysis*, **2020**, *189*, 113470.
17. Das Dibya, Halder Dhiman, Maji Himangshu Sekhar, Kumar De Pintu, Saha Sudipta, Singh Navjot, Pal Tapan Kumar, Introduction of an innovative approach for bioanalytical method development and validation of febuxostat by using LC-ESI-MS/MS in human plasma, *Research Journal of Pharmacy and Technology*, **2021**, *14*, 8, 4060-4066.
18. Amit Kumar J. Vyas, Sonali B. Mishra, A.B. Patel, N.K. Patel, S.R. Shah, D.B. Sheth, A Brief Review on Liquid Chromatography- Mass Spectrometry/LCMS and its Application, *Asian Journal of Pharmaceutical Analysis*, **2022**, *12*, 3, 203-0. doi: 10.52711/2231-5675.2022.00034
19. Kareem M. Younes, Ehab F. El-Kady, Eman S. Elzanfaly, Determination of Febuxostat in Human Plasma Using RP-LC–UV Method, *Journal of Chromatographic Science*, **2016**, *54*, 6, 1022–1027. <https://doi.org/10.1093/chromsci/bmw040>
20. Jayesh M Rajput, Dhanshri S Nandre, Bhagyashri G Pawar, A Comprehensive Review on Advanced Chromatographic Techniques and Spectroscopic Techniques in Pharmaceutical

- Analysis, *International Journal of Pharmaceutical Research and Applications*, **2022**, 7, 3, 53-62.
21. Bishoy Kamel, Garry G. Graham, Sophie L. Stocker, Zhixin Liu, Kenneth M. Williams, Jane E. Carland, Kevin D. Pile, Richard O. Day, A pharmacokinetic-pharmacodynamic study of a single dose of febuxostat in healthy subjects, *Br J Clin Pharmacol*, **2020**, 86, 2486–2496. <https://doi.org/10.1111/bcp.14357>
22. Chao-Jung Chen, Der-Yen Lee, Jiabin Yu, Yu-Ning Lin, Tsung-Min Lin, Recent advances in LC-MS-based metabolomics for clinical biomarker discovery, *Mass Spectrometry Reviews*, **2023**, 42, 6, 2349-2378.
23. Anna-Karin Sohlenius-Sternbeck, Ylva Terelius, Evaluation of ADMET Predictor in Early Discovery Drug Metabolism and Pharmacokinetics Project Work, *Drug Metabolism and Disposition*, **2022**, 50, 2, 95-100. <https://doi.org/10.1124/dmd.121.000552>
24. S. Sharma, N. Singh, A.D. Ankalgi, A. Rana, M.S. Ashawat, Modern Trends in Analytical Techniques for Method Development and Validation of Pharmaceuticals: A Review, *JDDT*, **2021**, 11, 1-S, 121-30. <https://www.jddtonline.info/index.php/jddt/article/view/4515>
25. K. Pramod, Deep A. Amar, K. Pooja, Singh A. Mahendra, An overview: LC-MS as tool of sample extraction and quantification in bioanalytical laboratories, *Asian Journal of Pharmaceutical Analysis*, **2020**, 10, 3, 165-172.
26. Faraz Rahimi, Stelios Chatzimichail, Aliyah Saifuddin, Andrew J. Surman, Simon D. Taylor-Robinson, Ali Salehi-Reyhani, A Review of Portable High-Performance Liquid Chromatography: The Future of the Field? *Chromatographia*, **2020**, 83, 1165–1195. <https://doi.org/10.1007/s10337-020-03944-6>
27. R.P. Bhole, S.R. Jagtap, K.B. Chadar, Y.B. Zambare, Liquid Chromatography-Mass Spectrometry Technique-A Review, *Research Journal of Pharmacy and Technology*, **2020**, 13, 1, 505-516. DOI: 10.5958/0974-360X.2020.00097.9

28. A. Rappold Brian, Review of the Use of Liquid Chromatography-Tandem Mass Spectrometry in Clinical Laboratories: Part I-Development, *Ann Lab Med*, **2022**, *42*, 2, 121-140.
29. A. Pyka-Pajak, Special Issue on “Applications of Chromatographic Separation Techniques in Food and Chemistry”, *Processes*, **2024**, *12*, 2, 304.  
<https://doi.org/10.3390/pr12020304>
30. B. Srinivas, Bhaskar Mangalapu, Ramesha Andagar Ramakrishna, M.B. Madhusudana Reddy, Swagata Halder, P. Venkata Narayana, A Comprehensive Review of Current and Emerging Analytical Techniques for the Identification, Quantification, and Assessment of Genotoxic Impurities in Drug Substances, *Eur. Chem. Bull.*, **2023**, *12*, 10, 12526-12564.
31. Christoph Seger, Linda Salzmann, After another decade: LC–MS/MS became routine in clinical diagnostics, *Clinical Biochemistry*, **2020**, *82*, 2-11.  
<https://doi.org/10.1016/j.clinbiochem.2020.03.004>
32. Marco Beccaria, Deirdre Cabooter, Current developments in LC-MS for pharmaceutical analysis, *Analyst*, **2020**, *145*, 4, 1129-1157.  
<http://dx.doi.org/10.1039/C9AN02145K>
33. Bin Fan, Ping Zhang, Xiaoyu Li, Efficacy and safety of Febuxostat Versus Allopurinol in Hyperuricemic patients with or without Gout: A meta-analysis, *Neuroendocrinol Lett.*, **2020**, *41*, 4, 195–204.
34. Arrigo F.G. Cicero, Federica Fogacci, Raffaele Ivan Cincione, Giuliano Tocci, Claudio Borghi, Clinical Effects of Xanthine Oxidase Inhibitors in Hyperuricemic Patients, *Med Princ Pract.*, **2021**, *30*, 2, 122–130. <https://doi.org/10.1159/000512178>
35. Ruixia Sun, Jie Lu, Hui Li, Xiaoyu Cheng, Ying Xin, Changgui Li, Evaluation of febuxostat initiation during an acute gout attack: A prospective, randomized clinical trial, *Joint Bone Spine*, **2020**, *87*, 5, 461-466.

36. K.I. Kraev, M.G. Geneva-Popova, B.K. Hristov, P.A. Uchikov, S.D. Popova-Belova, M.I. Kraeva, Y.M. Basheva-Kraeva, N.S. Stoyanova, V.T. Mitkova-Hristova, Celebrating Versatility: Febuxostat's Multifaceted Therapeutic Application, *Life*, **2023**, *13*, 11, 2199.
37. **M.A.B. Siddiq**, Evidence-Based Management of Gout - A Systematic Search and Review. Preprints, **2020**. <https://doi.org/10.20944/preprints202012.0156.v1>
38. Y. Zhang, S. Chen, M. Yuan, Y. Xu, H. Xu, Gout and Diet: A Comprehensive Review of Mechanisms and Management, *Nutrients*, **2022**, *14*, 17, 3525.  
<https://doi.org/10.3390/nu14173525>
39. Santwona Dash, Sabita Pattanayak, Barsarani Jena, Manasa K. Panda, Yengkhom D. Singh, Xanthine Oxidase Perspective in Human Health, *Current Biotechnology*, **2020**, *9*, 4, 255-262.
40. **A. Charlton**, J. Garzarella, K.A.M. Jandeleit-Dahm, J.C. Jha, Oxidative Stress and Inflammation in Renal and Cardiovascular Complications of Diabetes, *Biology*, **2021**, *10*, 1, 18. <https://doi.org/10.3390/biology10010018>
41. **M.F.S. de Abreu**, C.A. Wegermann, M.S. Ceroulo, I.G.M. Sant'Anna, R.C.S. Lessa, Ten Years Milestones in Xanthine Oxidase Inhibitors Discovery: Febuxostat-Based Inhibitors Trends, Bifunctional Derivatives, and Automatized Screening Assays, *Organics*, **2022**, *3*, 4, 380-414. <https://doi.org/10.3390/org3040026>
42. Tingting Wang, Di Zhang, Dong Sun, Jingkai Gu, Current status of *in vivo* bioanalysis of nano drug delivery systems, *Journal of Pharmaceutical Analysis*, **2020**, *10*, 3, 221-232.
43. **Aleš Kvasnička**, **David Friedecký**, **Radana Brumarová**, **Markéta Pavlíková**, **Kateřina Pavelcová**, **Jana Mašínová**, **Lenka Hasíková**, **Jakub Závada**, **Karel Pavelka**, **Pavel Ješina**, **Blanka Stibůrková**, Alterations in lipidome profiles distinguish early-onset hyperuricemia, gout, and the effect of urate-lowering treatment, *Arthritis Res Ther*, **2023**, *25*, 234.  
<https://doi.org/10.1186/s13075-023-03204-6>

44. Valentina Greco, Marcello Locatelli, Fabio Savini, Ugo de Grazia, Ottavia Montanaro, Enrica Rosato, Miryam Perrucci, Luigi Ciriolo, Abuzar Kabir, Halil Ibrahim Ulusoy, Cristian D'Ovidio, Imran Ali, Alessandro Giuffrida, New Challenges in (Bio)Analytical Sample Treatment Procedures for Clinical Applications, *Separations*, **2023**, *10*, 1, 62. <https://doi.org/10.3390/separations10010062>
45. Dipali Sonawane, Amit Kumar Sahu, Tarang Jadav, Rakesh Kumar Tekade, Pinaki Sengupta, Innovation in Strategies for Sensitivity Improvement of Chromatography and Mass Spectrometry Based Analytical Techniques, *Critical Reviews in Analytical Chemistry*, **2023**, *53*, 3, 655-671.
46. Eva-Maria Harrieder, Fleming Kretschmer, Sebastian Böcker, Michael Witting, Current state-of-the-art of separation methods used in LC-MS based metabolomics and lipidomics, *Journal of Chromatography B*, **2022**, *1188*, 123069.
47. Leonardo Perez de Souza, Saleh Alseekh, Federico Scossa, Alisdair R. Fernie, Ultra-high-performance liquid chromatography high-resolution mass spectrometry variants for metabolomics research, *Nat Methods*, **2021**, *18*, 733–746. <https://doi.org/10.1038/s41592-021-01116-4>
48. Hector Gallart-Ayala, Tony Teav, Julijana Ivanisevic, Metabolomics meets lipidomics: Assessing the small molecule component of metabolism, *Bio Essays*, **2020**, *42*, 12, 2000052.
49. T. Tuzimski, A. Petruczynik, Review of Chromatographic Methods Coupled with Modern Detection Techniques Applied in the Therapeutic Drugs Monitoring (TDM), *Molecules*, **2020**, *25*, 17, 4026. <https://doi.org/10.3390/molecules25174026>
50. E. Deschamps, V. Calabrese, I. Schmitz, M. Hubert-Roux, D. Castagnos, C. Afonso, Advances in Ultra-High-Resolution Mass Spectrometry for Pharmaceutical Analysis, *Molecules*, **2023**, *28*, 5, 2061. <https://doi.org/10.3390/molecules28052061>

51. R. Swetha Sri, K. Bhavya Sri, Ch. Mounika, A Review on Comparative study of HPLC and UPLC, *Research Journal of Pharmacy and Technology*, **2020**, *13*, 3, 1570-1574.
52. Shima A. Mahmoud, Amira M. El-Kosasy, Fatma A. Fouad, Green UHPLC Method for Simultaneous Determination of Febuxostat and Diclofenac in Pharmaceutical Dosage Form and Human Plasma, *Journal of Analytical Sciences, Methods and Instrumentation*, **2021**, *11*, 4.
53. Isil Gazioglu, S. Evrim Kepekci Tekkeli, Angela Tartaglia, Ceylin Aslan, Marcello Locatelli, Abuzar Kabir, Simultaneous determination of febuxostat and montelukast in human plasma using fabric phase sorptive extraction and high-performance liquid chromatography-fluorimetric detection, *Journal of Chromatography B*, **2022**, 1188:123070. <https://doi.org/10.1016/j.jchromb.2021.123070>.
54. Jiawen Lyu, Yan Wang, Chengfei Ruan, Xiaolei Zhang, Kejia Li, Mingliang Ye, Mechanical stress induced protein precipitation method for drug target screening, *Analytica Chimica Acta*, **2021**, 1168.
55. Michael J. Quintana, Alike Z. Shum, Michael S. Folsie, Prerana C. Ramesh, Shahab Ahmadzadeh, Giustino Varrassi, Sahar Shekoohi, Alan D. Kaye, Gout Treatment and Clinical Considerations: The Role of Pegloticase, Colchicine, and Febuxostat, *Cureus*, **2023**, *15*, 10, e46649.
56. Nabil A. Alhakamy, Usama A. Fahmy, Osama A. A. Ahmed, Enas A. Almohammadi, Shahad A. Alotaibi, Raghad A. Aljohani, Waleed S. Alharbi, Mohamed A. Alfaleh, Mohammad Y. Alfaifi, Development of an optimized febuxostat self-nanoemulsified loaded transdermal film: in-vitro, ex-vivo and in-vivo evaluation, *Pharmaceutical Development and Technology*, **2020**, *25*, 3, 326-331.

57. Anjali V. Patil, Abhijit N. Daf, Development & Validation for Estimation of Anti-Hyperuricemic Drug By RP-HPLC Method From Dosage Form, IJNRD, **2023**, 8, 3. ISSN: 2456-4184.
58. B. Patel, H. Thakkar, Formulation Development of Fast Dissolving Microneedles Loaded with Cubosomes of Febuxostat: *In Vitro* and *In Vivo* Evaluation, *Pharmaceutics*, **2023**, 15, 1, 224. <https://doi.org/10.3390/pharmaceutics15010224>
59. Das Zheng Shi, Jian Liu, Xing-Jiang Hu, Jian-Zhong ShenTu, Development of a simple LC-MS/MS method for the determination of febuxostat in human plasma and its application to a bioequivalence study, *Pharmazie*, **2013**, 68: 396–400.
60. Kareem M. Younes, Ehab F. El-Kady, Eman S. Elzanfaly, Determination of Febuxostat in Human Plasma Using RP-LC–UV Method, *Journal of Chromatographic Science*, **2016**, 54, 6, 1022–1027.
61. Sudhir S. Muvvala, Venkata Nadh Ratnakaram, Rama Rao Nadendla, A Validated RP-HPLC Method for the Estimation of Febuxostat in Bulk Drugs, *Int. J. Pharm Tech Res*, **2012**, 4, 4, 1358-1366.
62. Miglena Smerikarova, Stanislav Bozhanov, Vania Maslarska, Validation of Rapid and Simple HPLC-UV Method for Diflunisal Determination in Bulk Drug and Human Plasma, *Indian Journal of Pharmaceutical Education and Research*, **2023**, 57, 1, 278-285.
63. Sudarshan Balasaheb Kakad, Mahesh Hari Kolhe, Tushar Pradip Dukre, A Review on Pharmaceutical Validation, *IJPQA*, **2020**, 11, 3, 338-342.
64. Saraswathisreeram Pranush Kumar, Deeki Doma Sherpa, Amit Kumar Sahu, Tarang Jadav, Rakesh Kumar Tekade, Pinaki Sengupta, Innovation in bioanalytical strategies and in vitro drug–drug interaction study approaches in drug discovery, *Bioanalysis*, **2021**, 13, 6, 513-532.

65. Ramanlal N. Kachave, Pragati B. Mandlik, Snehal R. Wakchaure, A Review on Analytical Methods of Antigout Agents, *Journal of Reports in Pharmaceutical Sciences*, **2020**, *9*, 1, 136-167.
66. A.F.G. Cicero, F. Fogacci, V. Di Micoli, C. Angeloni, M. Giovannini, C. Borghi, Purine Metabolism Dysfunctions: Experimental Methods of Detection and Diagnostic Potential, *International Journal of Molecular Sciences*, **2023**, *24*, 8, 7027.  
<https://doi.org/10.3390/ijms24087027>
67. Vrushali Kharate, Mohini Kuchekar, Minal Harde, Bhushan Pimple, Vinita Patole, Manisha Salunkhe, Pooja Wadgave, Manish Bhise, Asmita Gaikwad, Harshal Tare, Development of Validated Stability Indicating HPTLC Method for Estimation of Febuxostat in Bulk and Tablet Dosage Form by Using QBD Approach, *IJDDT*, **2023**, *13*, 2, 542-550.
68. Aaron Stella, Subhakar Dey, A Sensitive and Specific ESI-Positive LC–MS/MS Method for the Quantitation of Estrogens in Human Serum in Under Three Minutes, *Journal of Chromatographic Science*, **2021**, *59*, 3, 280–288.  
<https://doi.org/10.1093/chromsci/bmaa104>
69. Babu Rao Chandu, Kanchanamala Kanala, Nagiat T. Hwisa, Prakash Katakam, Mukkanti Khagga, Bioequivalence and pharmacokinetic study of febuxostat in human plasma by using LC-MS/MS with liquid-liquid extraction method, *Springer Plus*, **2013**, *2*, 194.
70. Haidong Wang, Pan Deng, Xiaoyan Chen, Lixia Guo, Dafang Zhonga, Development and validation of a liquid chromatography–tandem mass spectrometry method for the determination of febuxostat in human plasma, *Biomed. Chromatogr*, **2012**, DOI 10.1002/bmc.2744
71. Venkata Rami Reddy Vaka, Jaswanth Kumar Inamadugu, Nageswara Rao Pilli, Mullangi Ramesh, Hussain Reddy Katreddi, A sensitive LC-MS/MS method for the quantification of

- febuxostat in human plasma and its pharmacokinetic application, *Biomed. Chromatogr*, **2013**, DOI 10.1002/bmc.2936
72. Yichao Xu, Jinliang Chen, Dandan Yang, Yin Hu, Xinhua Hu, Bo Jiang, Zourong Ruan, Honggang Lou, Development of LC-MS/MS determination method and backpropagation artificial neural networks pharmacokinetic model of febuxostat in healthy subjects, *J Clin Pharm Ther*, **2020**, *00*, 1–10.
73. Narottam Pal, Avanapu Srinivasa Rao, Pigilli Ravikumar, New Method Development and Validation for the Determination of Febuxostat in Human Plasma by Liquid Chromatography–Mass Spectrometry, *Int J Pharm Pharm Sci*, **2016**, *8*, 9, 61-70.
74. Surya Prakasarao Kovvasu, Steven Yeung, Priyanka Kunamaneni, Balaji Kodali, Bioanalysis of Febuxostat in Human Plasma by Liquid Chromatography/Tandem Mass Spectrometry, *International Journal of PharmTech Research*, **2018**, *11*, 2, 168-176.
75. Yingli Wu, Zhengsheng Mao, Youping Liu, Xin Wang, Xin Di, Simultaneous determination of febuxostat and its three active metabolites in human plasma by liquid chromatography–tandem mass spectrometry and its application to a pharmacokinetic study in Chinese healthy volunteers, *Journal of Pharmaceutical and Biomedical Analysis*, **2015**, *114*, 216–221.
76. Dinesh S. Patel, Naveen Sharma, Mukesh C. Patel, Bhavin N. Patel, Pranav S. Shrivastav, Mallika Sanyal, Liquid Chromatography Tandem Mass Spectrometry Method for Determination of Febuxostat in Human Plasma to Support a Bioequivalence Study, *Journal of Advanced Pharmaceutical Science and Technology*, **2013**, DOI: 10.14302/issn.2328-0182.japst-12-173
77. Ojikummar Lukram, Shivaji Parmar, Amit Hande, Determination of febuxostat in human plasma using ultra-performance liquid chromatography tandem mass spectrometry, *Drug Test. Analysis*, **2012**, DOI 10.1002/dta.420

78. Balaji N, Sayeeda Sultana, Ultra-High Performance Liquid Chromatographic Determination of Genotoxic Impurities in Febuxostat Drug Substance and Products, *Asian J Pharm Clin Res*, **2017**, *10*, 1, 324-330.
79. Rajesh Kanagaddi, Satya Sree Nannapaneni, Naresh Kumar Katari, J.N.S.R.C. Murty, Suresh Salakolusu, Shashipal Aitha, Mahesh Ranga, Muralidharan Kaliyapermal, Forced degradation study of Febuxostat: Isolation and structural characterization of degradation products, **2023**.  
[https://papers.ssrn.com/sol3/papers.cfm?abstract\\_id=4369314](https://papers.ssrn.com/sol3/papers.cfm?abstract_id=4369314)
80. Saurabh B Ganorkar, Yvan Vander Heyden, Recent trends in pharmaceutical analysis to foster modern drug discovery by comparative in-silico profiling of drugs and related substances, *TrAC Trends in Analytical Chemistry*, **2022**, *157*, 116747.
81. N. Balaji, Sayeeda Sultana, UPLC determination of genotoxic impurities in febuxostat drug substance and products, *Recent Advances in Pharmaceutical Sciences*, **2022**, *6*, 234-253. Publisher: Innovare Academics.
82. Mustakhusen H. Kadivara, Praveen Kumar Sinhaa, Dharmendra Kushwaha, Pijush Jana, Hitesh Sharma, Atul Bapodra, Study of impurity carryover and impurity profile in Febuxostat drug substance by LC–MS/MS technique, *Journal of Pharmaceutical and Biomedical Analysis*, **2011**, *56*, 749-757.
83. N. Balaji, Sayeeda Sultana, Trace Level Determination and Quantification of Potential Genotoxic Impurities in Dasatinib Drug Substance by UHPLC/Infinity LC, *International Journal of Pharmacy and Pharmaceutical Sciences*, **2016**, *8*, 10, 209-216.
84. N. Balaji, S Sultana, Ultra-fast Liquid Chromatographic Determination of Potential Genotoxic Impurities in Dasatinib Drug Substance at Trace Level, *Challenges and Advances in Pharmaceutical Research*, **2022**, *10*, 150-169.

85. Margaret N. Ruesch, Luca Benetti, Eileen Berkay, David J. Cirelli, Neha Frantz, Martin H. Gastens, Wayne P. Kelley, Juliana Kretsinger, Mike Lewis, Shawn Novick, Barbara Rellahan, Laura Pack, Corné J.M. Stroop, Ann Subashi, Ping Yin, Ming Zeng, John Stults, Strategies for Setting Patient-Centric Commercial Specifications for Biotherapeutic Products, *Journal of Pharmaceutical Sciences*, **2021**, *110*, 2, 771-784.
86. David S. Bell, Ahren I. Green, Diego A. Lopez, Columns - What is on Your HPLC Particle? A Look at Stationary Phase Chemistry Synthesis, *LCGC Asia Pacific*, **2021**, *24*, 1, 28–33.
87. Deyber Arley Vargas Medina, Edvaldo Vasconcelos Soares Maciel, Fernando Mauro Lanças, Miniaturization of liquid chromatography coupled to mass spectrometry. 3. Achievements on chip-based LC–MS devices, *TrAC Trends in Analytical Chemistry*, **2020**, *131*, pp. 116003.
88. Shivani Puri, Dinkar Sahal, Upendra Sharma, A conversation between hyphenated spectroscopic techniques and phytometabolites from medicinal plants, *Anal Sci Adv*, **2021**, *2*, 579–593. <https://doi.org/10.1002/ansa.202100021>
89. Daniel G. Delafield, Gaoyuan Lu, Cameron J. Kaminsky, Lingjun Li, High-end ion mobility mass spectrometry: A current review of analytical capacity in omics applications and structural investigations, *TrAC Trends in Analytical Chemistry*, **2022**, *157*, 116761.
90. Mei Han, Yunan Wang, Kevin Cook, Noor Bala, Marcus Soto, Dan A. Rock, Josh T. Pearson, Brooke M. Rock, S-1 Universal Automated Immunoaffinity Purification-CE-MS Platform for Accelerating Next Generation Biologic Design, *Anal. Chem.*, **2021**, *93*, 13, 5562–5569.
91. M.B.M.A. Rashid, Artificial Intelligence Effecting a Paradigm Shift in Drug Development, *SLAS TECHNOLOGY: Translating Life Sciences Innovation*, **2021**, *26*, 1, 3-15.  
doi:10.1177/2472630320956931

92. C. Sarkar, B. Das, V.S. Rawat, J.B. Wahlang, A. Nongpiur, I. Tiewsoh, N.M. Lyngdoh, D. Das, M. Bidarolli, H.T. Sony, Artificial Intelligence and Machine Learning Technology Driven Modern Drug Discovery and Development, International Journal of Molecular Sciences, **2023**, 24, 3, 2026. <https://doi.org/10.3390/ijms24032026>
93. Niloufar Maghsoudnia, Reza Baradaran Eftekhari, Alireza Naderi Sohi, Ali Zamzami, Farid Abedin Dorkoosh, Application of nano-based systems for drug delivery and targeting: a review, J Nanopart Res, **2020**, 22, 245. <https://doi.org/10.1007/s11051-020-04959-8>
94. P.S. Aithal, Architha Aithal, Edwin Dias, Blockchain Technology - Current Status and Future Research Opportunities in Various Areas of Healthcare Industry, International Journal of Health Sciences and Pharmacy, **2021**, 5, 1, 130-150.
95. Balaji Nagarajan, Sayeeda Sultana, Reversed-phase UHPLC enantiomeric separation of Rasagiline salts using a chiralpak@ AGP column, Scientia Pharmaceutica, 2017, 85, 3, 26.
96. Balaji N, Sivaraman VR, Neeraja P. A validated uplc method for the determination of process-related impurities in the antimigraine bulk drug. J Appl Chem 2013; 3:20-8.
97. Balaji Nagarajan, Gunasekar Manoharan, Stability-Indicating HPLC method for the determination of related substances in Lansoprazole Intermediate, International journal of engineering science technologies, 2022, 6, 3, 20-27.
98. Balaji Nagarajan, Gunasekar Manoharan, Stability-indicating HPLC method for the determination of related substances in lansoprazole sulphide, International Journal of science and technology research archive, 2022, 3, 1, 1-7.
99. Balaji N, Sivaraman VR, P Neeraja, GC quantification of residual hexylmethane sulfonate in dabigatran etexilate mesylate, IOSR Journal of applied chemistry, 2012, 2, 48-51.
100. Balaji Nagarajan, Gunasekar Manoharan, Vishal Ramani, Logudurai Radhakrishnan, Trace level determination of 1-Chlorobutane in Candesartan Cilexetil Drug Substance, 2022, 10, 8, 519-525.