

---

# DESIGN OF DIGITAL LUX METER BASED ON ARDUINO USING EL7900 PHOTODIODE SENSOR

## ABSTRACT

**Aims:** To design and manufacture digital lux meter to the illumination intensity (E) detection tool that is more efficient, relatively cheaper and can be carried because it has a smaller shape and size compared to tools on the market

**Study design:** Design of lux meter digital based on Arduino using EL7900 sensor.

**Place and Duration of Study:** Physics Study Program, Faculty of Mathematics and Natural Sciences, Udayana University, from June 2024 to September 2024.

**Methodology:** The method used is to design electronic components so that it can become a digital lux meter. The main processor uses Arduino. The microcontroller functions as a data processor which is the output of the EL 7900 sensor. The HC-SR04 sensor is a distance sensor whose function is to measure the distance measured on the design tool. The detection results from the sensor are then processed in the microcontroller and displayed on the OLED

**Result:** Lux meter digital based on Arduino using EL7900 sensor have been produced. The results of the research show that the further the measurement distance from the light source, the illumination intensity (E) decreases. This research also finds that the illumination intensity will increase if the source power is increased. Based on calibration testing between the design tool and the reference tool, it shows very good results with an error rate of 0.06%. Field test results showed that the level of accuracy of the illumination intensity between the design tool and the reference tool at a distance of 150 cm from the light source with different light source power reached 99.48

**Conclusion:** In this research, has been produced digital lux meter to the illumination intensity (E) detection tool, relatively cheaper and can be carried because it has a smaller shape and size compared to tools on the market. Based on calibration testing, it shows very good results with an error rate of 0.06 %.

*Keywords: Light; Distance ;Lux meter;EL 7900 sensor.*

## 1. INTRODUCTION

Light in a room plays an important role in life. Lighting is one of the most important factors in space design (Abdollahi, 2021). Each designed room requires different lighting strengths to suit the needs and functions of the room (Kong & Jakubiec, 2021). The use of ineffective and inefficient room lighting can reduce comfort and cause waste (Belanyetal, 2021; Choetal., 2020). Understanding of lighting and measuring instruments for measuring lighting strength has not received serious attention in society, especially among the general public. Technological advances have brought us to an era where sophisticated sensors play an important role in understanding and utilizing the surrounding environment. One of the crucial sensors in many applications is the light sensor, which allows us to measure the lighting strength around us with very accurate precision. The measuring instrument for lighting strength in a room is a lux meter. The unit of measurement for a lux meter is lux. Lux meters are equipped with light sensors that are sensitive to changes in the amount of light received. All lux meters consist of a frame, a sensor with a photo cell and a panel layer. The sensor is placed on the light source to be measured (NurHudha, et al., 2021). Based on the description above, this study aims to design and manufacture a digital lux meter based on the EL7900 light sensor as the main focus of exploration and innovation in lighting strength.

### 1.1 Sensor Photodiode EL7900

The EL7900 photodiode is a light detector that converts light intensity into electric current. The EL7900 photodiode is packaged in an integrated circuit (IC) that contains a combination of a photodiode and a current amplifier. This detector is capable of detecting light intensity with a range between 1 lux to 8,000 lux and requires a power supply between 2.7V to 5.5V. Pin assignment and spectral response of the EL7900 photodiode

The EL7900 photodiode is a light detector that converts light intensity into electric current. The EL7900 photodiode is packaged in an integrated circuit (IC) that contains a combination of a photodiode and a current amplifier. This detector is capable of detecting light intensity with a range between 1 lux to 8,000 lux and requires a power supply between 2.7 V to 5.5 V. Pin assignment and spectral response of the EL7900 photodiode

### 1.2 Arduino Uno R3

Arduino Uno R3 is a microcontroller development board based on the

(I / O) pins, where 14 of them can be used as PWM outputs including (pins 0 to 13), 6 analog input pins, using 16 MHz crystals including pins A0 to A5, USB connection, power jack, ICSP header and reset button. These are all that is needed to support a microcontroller circuit.

### **1.3 Organic Light Emitting Diode (OLED)**

Arduino Uno R3 is a microcontroller development board based on the ATmega328P chip. Arduino Uno R3 has 14 digital input / output (I / O) pins, where 14 of them can be used as PWM outputs including (pins 0 to 13), 6 analog input pins, using 16 MHz crystals including pins A0 to A5, USB connection, power jack, ICSP header and reset button. These are all that is needed to support a microcontroller circuit.

UNDER PEER REVIEW

## 2. METHODOLOGY

### 2.1 Design of System

The design diagram for the Arduino-based digital lux meter research using the EL7900 Photodiode sensor is shown in Figure 1. The block diagram in Figure 1 begins with the EL7900 Photodiode sensor which converts the input signal in the form of light intensity into an analog signal in the form of voltage. Furthermore, this signal is sent to the ATmega328P microcontroller located on the Arduino Uno R3 board. This data or signal is processed by the embedded program code on the microcontroller. The processed data is then displayed on OLED in the form of light intensity expressed in lux units.

### 2.2 Calibration Methods

The calibration and testing process of the design tool is carried out by comparing the results of the lighting intensity measurements between the design tool and the standard tool. Quantitatively, the level of accuracy or linearity of the design tool is carried out by the linear regression process. Light intensity calibration is carried out with variations in distance ranging from 25 cm to 100 cm, with an interval of 25 cm. Distance interval measurements are carried out for 10 seconds each. Calibration in this study was carried out to determine the level of accuracy of the design tool with the Smart Sensor AS803 lux meter as a reference in understanding the concept of light measurement, knowing the lighting strength of a light source and knowing

the relationship between distance and lighting strength. In this study, a flashlight was used as a light source.

## 3. RESULTS AND DISCUSSION

### 3.1 Results

Research on the design and manufacture of a digital lux meter based on Arduino using EL7900 photodiode sensor, was carried out at the Electronics and Instrumentation Laboratory of the Physics Study Program, Udayana University. The function of each component is as follows: Arduino Uno R3 with ATmega328P microcontroller is the main processor of all components in the circuit that functions as the center for processing input and output signals. The EL7900 sensor is a sensor that functions to detect light intensity. The battery functions as a power source for the digital lux meter. OLED 128 x 64 is a display media that functions to display data reading results. The appearance of the designed digital lux meter is shown in Figure 3. Figure 3 is the initial display of a digital lux meter based on Light using the EL7900 photodiode sensor. On the OLED the words lux meter digital are displayed. As for making the writing on the initial display, it is made in the Arduino IDE with the following program code. Figure 4 shows the results of reading the light intensity measurement data displayed on the OLED with a light intensity value of 15.83 Lux. The program code to display the results of reading the measurement data is as follows

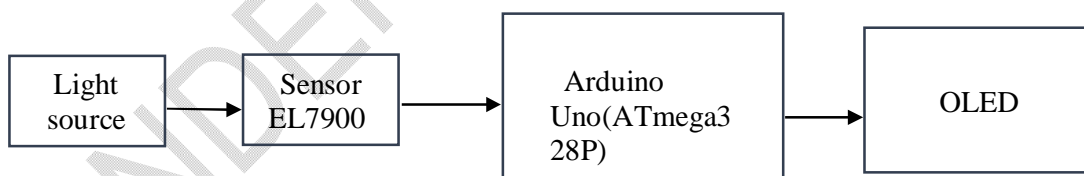

Figure 1. Block diagram of measuring instrument design

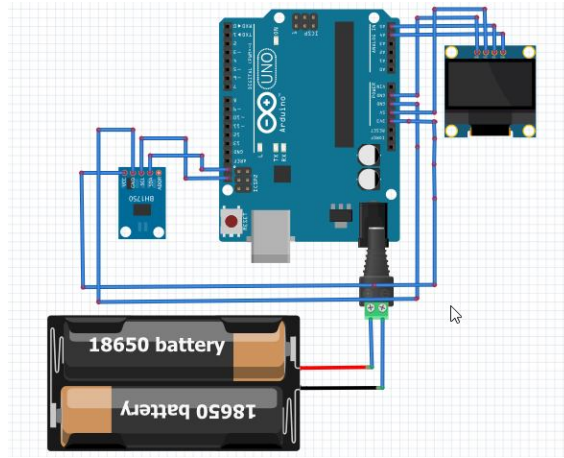

Fig.2.Resultofdesigntool

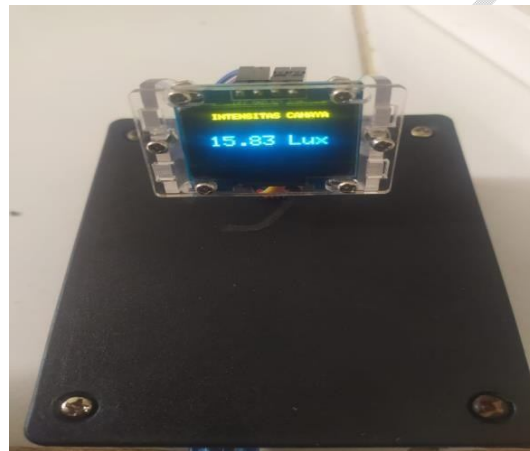

Fig3.ResultofReadingMeasurementDataforDesignTools

## 3.2 Discussion

### 3.2.1 Design Tool Calibration

The calibration and testing process of the design tool was carried out by comparing the results of the lighting strength measurements between the design tool and the standard tool. Calibration was carried out with variations in distance ranging from 25 cm to 100 cm, with an interval of 25 cm. The distance interval measurement was carried out for 10 seconds each. Calibration in this study was carried out to determine the level of accuracy of the design tool with the Smart Sensor AS803 luxmeter as a reference. In this study, a flashlight was used as a light source. The measurement results are shown in Table 1.

Table 1 shows the value of the illumination intensity (E) at a distance of 25 cm of the reference tool is 348 lux and the design tool is 336 lux. The value of the illumination intensity (E) at a distance of 50 cm of the reference tool is 247 lux and the design tool is 232 lux. While the illumination intensity at a distance of 75 cm of the reference tool is 173 lux and the design tool is 165 lux and the illumination intensity at a distance of 100 cm of the reference tool is 107 lux and the design tool is 97 lux. From this study it can be seen that the further the distance of the light source from the measuring instrument, the smaller the illumination intensity value obtained. This is in accordance with the formula of illumination intensity is inversely proportional to distance, meaning that if the distance is greater, the value of the illumination intensity of the light will be smaller. Likewise, vice versa, if the distance is smaller, the value of the illumination intensity of the light will be greater. In theory, the illumination intensity (E) in a plane because the light source with intensity I, decreases with the square of the distance between the light source and the plane, mathematically it can be written with the equation:

$$E = I/r^2 \quad (3-1)$$

Where E is the illuminance (lux), I is the luminous intensity (candela=cd)/(lumens=lm) and r is the distance of the plane from the light source (m). In theory, candela is a measure of light intensity in a certain direction or angle, for example light from a flashlight, or a laser whose measurement is focused in a certain direction, while lumens are the total light produced by a light source without taking into account the direction and angle of the light source, for example measuring TL lamps, LEDs.

To determine the level of accuracy of the design tool with the reference tool is shown in a regression graph as in Figure 4, showing the level of accuracy between the design tool and the reference tool is very good with a coefficient of determination  $R^2 = 0.9994$ , meaning that the level of conformity at the time of measurement reaches 99.94%. Figure 5 is a correlation graph of measurements between the reference tool and the design tool. Figure 5 shows a decrease in lighting intensity (E) has the same pattern between the design tool and the reference tool along with the increase in the measurement distance from the light source. There are differences in measurement results between the design tool and the reference tool. There are several factors that caused differences in measurement readings including tool distance, time and observation eye. This was also obtained by Dolera-Moreno et al., (2020) stating that observation time affects the magnitude of the light intensity, the longer the measurement, showing a more fluctuating value, meaning that the detected light becomes unstable (Ibañez et al., 2017).

### 3.2.2 Implementation of Design Tools

The application of the design tool is carried out using TL lamps with varying lamp power. The results of the study show that the lighting intensity (E) with varying lamp power at a distance of 150 cm from the light source as in Table 2.

**Table 1.** The lighting intensity value of the standard reference tool with the design tool

No	Distance(cm)	Illumination strength(E) reference device (lux)	Illumination strength(E) design tool(lux)
1	25	348	336
2	50	247	232
3	75	173	165
4	100	107	97

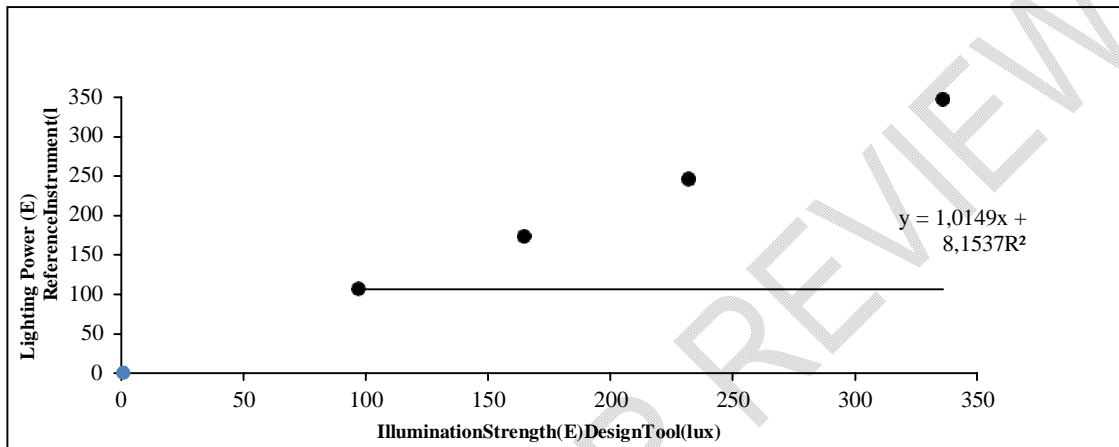

**Fig 4.** Regression graph between the illumination strength (E) of the design tool and the reference tool at a distance of 25, 50, 75, and 100 cm from the light source

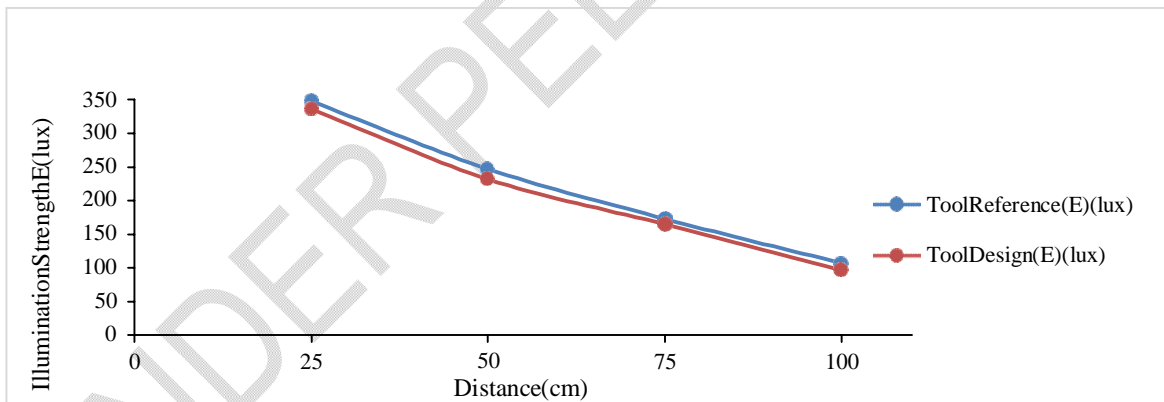

**Fig 5.** Calibration graph of lighting strength (E) between the design tool and the reference tool at a distance of 25, 50, 75, and 100 cm

**Table 2.** Results of measurements of lighting strength (E) at a distance of 150 cm from the light source, variations in light source power

No	Light source power (watts)	Illumination strength (E) reference device (lux)	Illumination strength (E) design tool (lux)
1	9	97	87
2	12	133	121
3	15	172	160
4	18	214	190

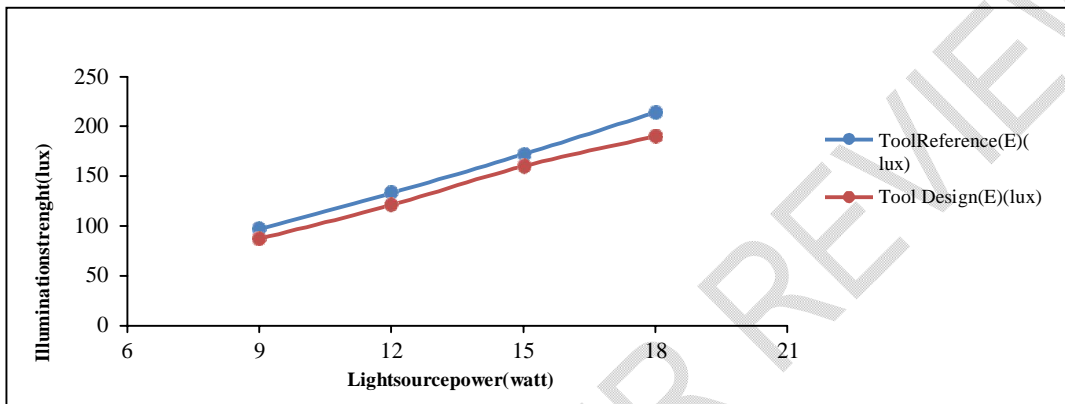

Fig 6. Regression graph of the lighting strength of the design tool and the reference tool at a distance of 150 cm from the light source using the variation function of the light source power.

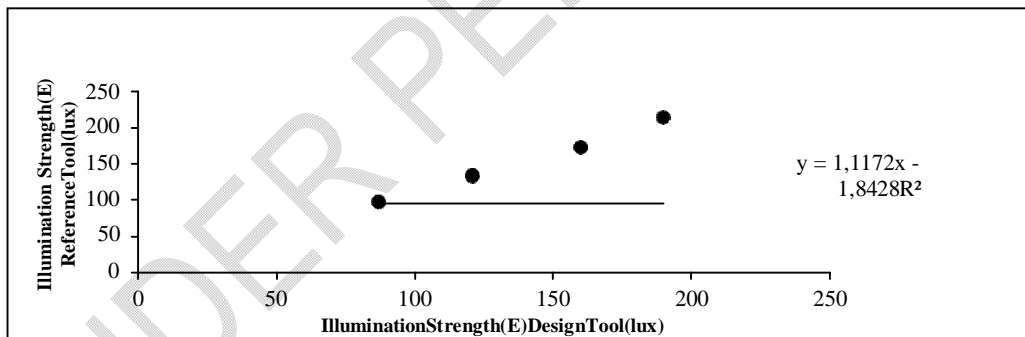

Fig 7. Regression graph of the lighting strength of the design tool with the reference tool at a distance of 150 cm from the light source, the function of the variation of the power of the light source

shows that the smaller the lamp power used, the smaller the lighting intensity value obtained. This is in accordance with the formula for lighting intensity is directly proportional to distance, meaning that if the light source power is greater, the lighting intensity value will be greater. Likewise, vice versa, if the light source power is smaller, the lighting intensity value will be smaller. To determine the level of accuracy of the design tool using regression as in Figure 6, shows that when measuring the same distance from the light source (150 cm), the lighting intensity

increases (increases) along with the increase in lamp power (light source), conversely the lighting intensity will decrease along with the decrease in the light source power, this is in accordance with the results of research by Ingram et al. (2019) that lighting intensity depends on the source power and distance from the light source. To determine the level of accuracy of the design tool using regression as in Figure 7, it shows that the level of accuracy of the design tool with the reference tool is 99.48%. which is indicated by the coefficient of determination  $R^2 = 0.9948$

## 4. CONCLUSION

The conclusions obtained are:

1. Design and manufacture digital lux meter based on Arduino Uno using EL 7900 sensor has been produced.
2. Design digital lux meter has been produced relatively cheaper and can be carried because it has a smaller shape and size compared to tools on the market.
3. The level of accuracy of the illumination intensity between the design tool and the reference tool at a distance of 150 cm from the light source reached 99.48%

## REFERENCES

1. Abdollahi, R. (2021). Design of lighting systems for sacred places with the approach of improving technical and economic conditions. *Ain Shams Engineering Journal*, 12(3), 2899-2905. <https://doi.org/10.1016/j.asej.2021.02.021>.
2. Bahrin. 2017. Lighting Control System Using Arduino Uno At ICHSAN University Gorontalo. *ILKOM Scientific Journal*. 9:283-284.
3. Belany, P., Hrabovsky, P., & Kolkova, Z. (2021). Combination of lighting retrofit and lifecycle cost analysis for energy efficiency improvement in buildings. *Energy Reports*, 7, 2470-2483 <https://doi.org/10.1016/j.egyr.2021.04.044>.
4. Cho, Y., Seo, J., Lee, H., Choi, S., Choi, A., Sung, M., & Hur, Y. (2020). Platform design for life log-based smart lighting control. *Building and Environment*, 185. <https://doi.org/10.1016/j.buildenv.2020.107267>.
5. Dólera-Moreno, C., Palazón-Bru, A., Colomina-Climent, F., & Gil-Guillén, V. F. (2020). Construction and internal validation of a new mortality risk score for patients admitted to the intensive care unit. *International Journal of Clinical Practice*, 70(1).
6. Efrianto, Ridwan., I. Fahrudi. 2016. Motor Security System Using Smartcard Batam State Polytechnic. *Integration Journal*. 8(1):2.
7. Fuada, S. 2017. Design of Control System on Digital IC-Based Cracker Dryer Prototype Using Proteus 7.0 Software. *Control System-Electric Power-Telecommunication-Computer*. 6(1):89.
8. Ibañez, C.A., Zafra, J.C.G., & Sacht, H.M. (2017). Natural and Artificial Lighting Analysis in a Classroom of Technical Drawing: Measurements and HDR Images Use. *Procedia Engineering*, 196, 964-971. <https://doi.org/10.1016/j.proeng.2017.08.037>.
9. Ingram, G. L., Zhao, Y. B., & Lu, Z. H. (2019). Exciton triggered luminance degradation of organic light emitting diodes. *Organic Electronics*, 69, 160-163. <https://doi.org/10.1016/j.orgel.2019.03.023>.
10. Kong, Z., & Jakubiec, J. A. (2021). Instantaneous lighting quality within higher educational classrooms in Singapore. *Frontiers of Architectural Research*, 10(4), 787-802. <https://doi.org/10.1016/j.foar.2021.05.001>.
11. Mutmainnah, I. Rofii., Misto & D.U. Azmi. 2020. Electrical and Optical Characteristics of LEDs and Lasers. *Journal of Theory and Applications of Physics*. 08(02):203-204.
12. Sari, K., C. Suhery & Y. Arman. 2015. Implementation of Fish Feed System Using Buzzer and Microcontroller Based Interface Application. *Untan Computer System Coding Journal* 03:112.
13. Suryani, E., Rully, A.H. & Ulfa, E.R. 2021. Implementation of Dynamic System Simulation Models in the Corn Industry. *CV Budi Utama*. Yogyakarta.
14. Suryantoro, H. & A. Budiyanto. 2019. Labview & Arduino Based Water Level Monitoring System Prototype as a Supporting Means for Control System Instrumentation. *Journal of Laboratory*. 1(3):22-23.
15. Winata, A.S. 2019. Arduino Uno and Android Based Digital Lock Encrypted Combination of Vigenere Cipher and Xor Cipher Algorithms. Undergraduate Study Program in Computer Science, Faculty of Computer Science and Information Technology, University of North Sumatra. Medan.