

An Acquisition Embedded System for Electrical Measurement Monitoring

ABSTRACT

Aims: This study aims to develop an integrated acquisition system to monitor electrical measurements.

Study design: acquisition embedded system is developed using research and development study.

Place and Duration of Study: Department of Machinery Automation System, Polytechnic A.T.I. Makassar, Indonesia, between March 2021 and October 2021.

Methodology: The performance of the proposed integrated acquisition embedded system and conventional measurement is compared through different testing.

Results: The results showed that the device worked as expected and was right on target. The device test error is compared with direct measurement with the measuring instrument; the voltage error is 0.17%, the current error is 0.46%, the power error is 0.89%, and the frequency error is 0.01%. System devices can measure and monitor several electricity measurements.

Conclusion: The experimental results show that the system can function correctly. The integrated acquisition system can operate with great accuracy. This study is expected to contribute to establishing a system that will benefit the government's efforts to preserve energy efficiency.

Keywords: Embedded System, Electrical, Energy Troubleshooting, Saving Electricity

1. INTRODUCTION

The vast growth of energy conversion technologies and the development of various equipment to support human activities contribute to a significant increase in electricity-related energy demand. The cost of electricity is rising with the increase in energy use [1], [2]. This situation worsens with the diminishing supply of fossil fuels as the primary source of power generation.

The increase in energy demand has forced the government to socialize the culture of energy conservation. The socialization for energy-saving might begin by using electrical energy intelligently in home and commercial buildings [3].

According to statistics, electricity contributed to around 35% of building energy use in 2022, up from 30% in 2010 worldwide [4]. In 2021, in the United States, the average yearly power usage for a home utility user was 10,632 kilowatt-hours (kWh), or approximately 886 kWh per month [5]. In Indonesia, total residential power demand increased from 84.1 terawatt-hours in 2014 to 111.4 terawatt-hours in 2020, despite a 0.98% annual population increase [6]. Then the previous works also stated that electricity demand is anticipated to rise much further in Indonesia. Therefore, energy conservation in residential buildings is needed and should be incorporated into government plans. In Indonesia, the government has released the guideline of the Minister of Energy and Mineral Resources (ESDM) on electricity energy savings to minimize electrical energy consumption by improving energy-

saving habits (i.e., changing the behavior of individuals who live in the building). It stipulates that all office buildings must use an energy-saving scheme for air conditioning, lighting, and other equipment.

With the rise in energy prices and the environmental difficulties associated with fossil fuel energy supply, many researchers have been working to promote green energy through alternative and renewable energy[7]. Starting from households, the smallest unit in society, energy efficiency can be achieved by optimizing lighting system consumption and designing lighting systems according to space functionality[8]. Most significantly, heating/cooling systems and ventilation should be continuously managed based on actual needs[9]. Effective power metering and monitoring systems are necessary to ensure efficient electrical energy consumption. The power metering and monitoring systems would provide valuable information to building owners and operators on the facility's energy use performance[10]. Owners can all be involved in evaluating energy consumption with an effective metering and monitoring system. As a result, significant actions should be taken immediately to ensure adequate energy use. The integrated energy management and monitoring system is enough to increase energy efficiency[11]. Therefore, an effective measurement and monitoring system may save energy, lowering the building's running costs.

There are two approaches to achieving energy efficiency: passive and active energy efficiency. Passive energy efficiency actions include the installation and use of energy-saving equipment as well as measures to rectify power factors[12], [13]. Passive energy efficiency is a crucial endeavor for energy conservation. Nevertheless, the passive technique is insufficient to achieve the needed level of energy efficiency[14]. Thus, it requires a system that can promote energy efficiency using an active approach. Energy efficiency necessitates an operational strategy such as load control, system automation, and energy use monitoring to achieve a better energy-saving plan, eventually improving energy efficiency performance.

The active approach technique's electric energy efficiency necessitates using an electrical energy monitoring system to provide reports and data analysis and communicate with various devices[15]–[17]. This system is linked to an electric load distribution panel, which can automatically record power use and adjust the electrical load. More crucially, the system must be embedded and be able to communicate with various measuring devices, send data across devices, store measurement data, and perform the numerous analyses required for decision-making. However, with the rapidly expanding information and communication technology field, the system must use effective communication techniques such as IP-based, autodial, and connectivity with mobile devices. Thus far, implementing the monitoring system with the requisite capabilities is prohibitively expensive. As a result, the installation of the energy-saving monitoring system is limited. Therefore, this study developed an open protocol device integrated into an acquisition embedded system capable of monitoring electrical energy and may aid in developing energy-saving cultures. A low-cost power monitoring and energy management system is devised for building premises.

The suggested system is linked to a distribution panel in each room and has an open communication protocol for remote monitoring. It has some advantages, such as the capacity to automatically data acquisition for tele-metering (i.e., current, voltage, frequency, active power, apparent power, and $\cos \phi$), tele-signaling (i.e., in the form of an alarm that occurs due to disturbances in the quality of electric power), tele-controlling (i.e., controlling the lighting system (Lighting Control) and Air Conditioning (HVAC Control)), and recommended troubleshooting system with application web to minimize downtime on the machine in the event of interference or trouble. This system consists of several sub-controllers that can communicate in an integrated way from each electronic device to the concentrator gateway, which operators can access anytime and anywhere. Compared to the

other research, the contribution of this study is the presence of troubleshooting features built into integrated and embedded systems. Also, the communication protocols will be implemented using universal standard protocols and open technology, namely the Modbus RTU Serial RS485 protocol and the Modbus TCP/IP Ethernet protocol and communication media using wired and wireless media.

2. MATERIAL AND METHODS

This study uses the research and development (R&D) approach to develop an integrated acquisition embedded system for electrical measurement.

The suggested system is developed by creating an integrated embedded system for monitoring electrical energy. Integrated acquisition embedded system development is divided into hardware and software design. The obtained design will then be realized to construct the embedded system. Finally, the embedded system is then tested to ensure its performance.

The first step of an integrated embedded system development is created as follows: (1) Design and manufacture integrated boards based on embedded systems for multiple control points. (2) Create a website system based on the WEB SCADA system to monitor the electrical energy. (3) perform system communication testing via wireless media. (4) testing the power profile data acquisition system (tele-metering, tele-signaling, and tele-controlling). (5) Carry out tests using an automatic spinner machine as a load. (6) Analyze experimental results, compare results before system implementation, and compare multiple configurations for optimization.

Then, the second step was designing and developing application software that is a PHP framework-based SCADA Web for monitoring systems.

2.1 The development of an integrated embedded system

In this step, this research addressed the design of an embedded system. An embedded system is proposed to connect and control the whole component. The P.C.B., wiring, and caching design for an embedded system can be seen in Fig. 1.

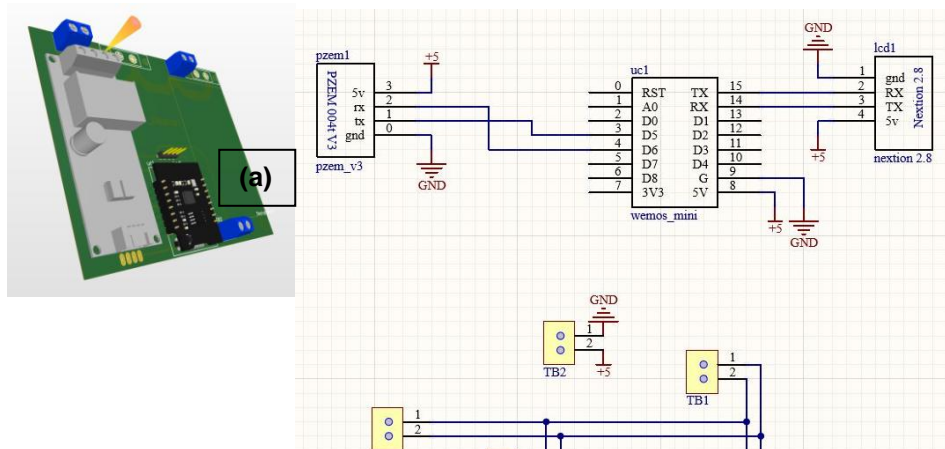

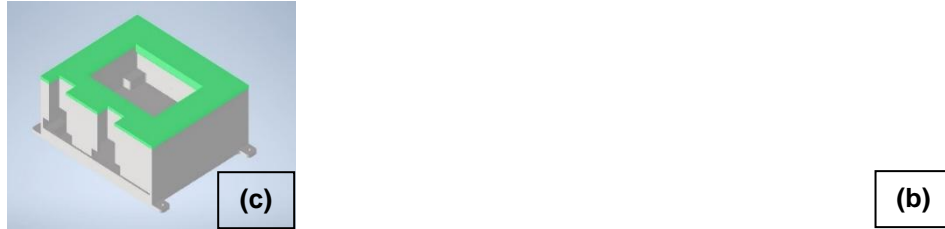

Fig.1.(a) P.C.B. Design; (b) Wiring Design, (c) Cashing design

Fig.1 (a) shows the P.C.B. design. This design was created and printed with the Altium app. The device subsystem (i.e., electric current, voltage, frequency, active power, apparent power, and $\cos \phi$) wiring can be seen in Fig.1 (b). Fig.1 (b) shows a series of subsystem devices made in this study. The values of electric current, voltage, power factor, and frequency are electrical quantities that will be acquired by the micro to be processed into power quality parameters such as active power, reactive power, apparent power, usage costs, and interference solutions. The results of this acquisition will be sent to the server, processed, and displayed on the following step application website. The casing is made using a 3D printer. The casing was designed using the 3D blender application. The three-dimensional design can be seen in Fig.1 (c).

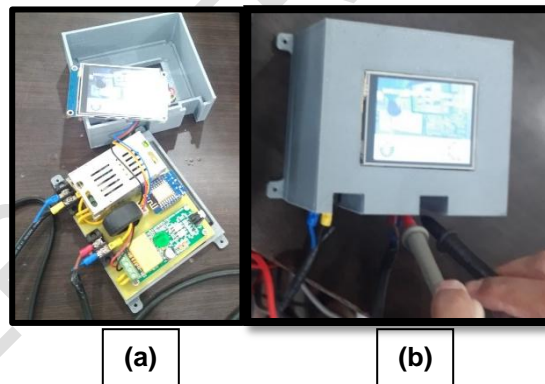

Fig.2.(a) inside of the device, (b) outside of the device

Fig.2 (a) shows the inside of the device, along with the casing and cover. The casing is made to protect it from interference by electrical touch, which can cause electrical hazards. The device's appearance when the casing is closed can be seen in Fig.2 (b). Fig.2 (b) shows the outside of the device after the inner device, which consists of a microcontroller, and its input and output are closed with a specially-made casing.

2.2 The development of application software for monitoring electrical energy

The second step is the application of software for monitoring electrical energy. All electrical acquisition data (i.e., electric current, voltage, frequency, active power, apparent

power, and cos phi) are stored in the MySQL database to be displayed again via a PHP-based Web application. This process is shown in Fig.3.

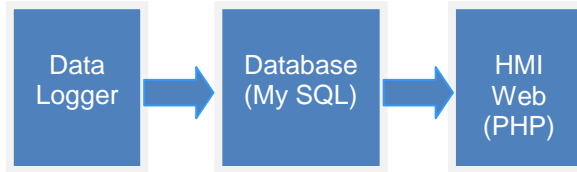

Fig.3. Data Application Block Diagram

Some Arduino program listings for data acquisition to computer displays via serial monitors can be seen in Fig. 4.

```
1 #include <EmonLib.h>
2 EnergyMonitor emon1;
3 void setup()
4 {
5   Serial.begin(9600);
6   emon1.voltage(2, 205.89, 6);
7   emon1.current(1, 1.26);
8 }
9 void loop()
10 {
11   emon1.calcVI(20, 2000);
12   unsigned int long timemillis = millis();
13   unsigned int long time = timemillis / 1000;
14   float realPower = abs(emon1.realPower);
15   float apparentPower = abs(emon1.apparentPower);
16   float powerFactor = abs(emon1.powerFactor);
17   float supplyVoltage = abs(emon1.Vrms);
18   float Irms = abs(emon1.Irms);
19   float kwh = abs(realPower*time)/abs(1000*3600);
20   Serial.print(realPower); Serial.print(" ");
21   Serial.print(apparentPower); Serial.print(" ");
22   Serial.print(supplyVoltage); Serial.print(" ");
23   Serial.print(Irms); Serial.print(" ");
24   Serial.print(powerFactor); Serial.print(" ");
25   Serial.print(kwh); Serial.println(" ");
26 }
```

Fig.4. Program code for Electrical Power Profile Measurement

The designed integrated acquisition system for monitoring electrical energy will have several features, such as autorunning, calibration, monitoring, and several other parameter settings.

The next step after all the systems are made is to access the web via <https://spirit2021.bpsdmikemenperin.xyz/> to monitor the condition of the electric voltage when not loaded and loaded. The website page is accessed and logged in by entering the email and password that was previously registered. This limited or password access is used as security to limit access to the system.

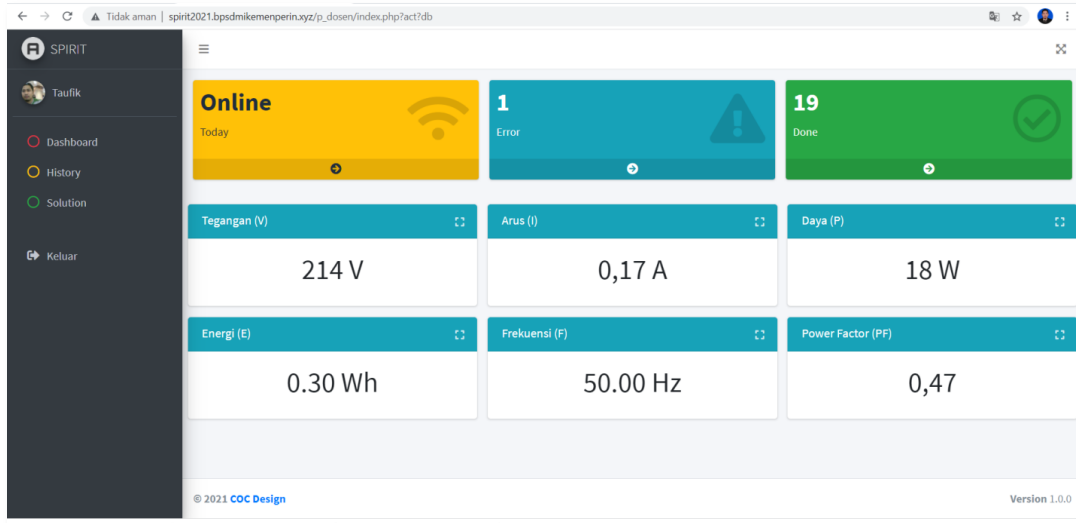

Fig.5.Dashboard Page Display

Fig.5 shows the voltage, electric current, active power, energy, frequency, and power factor values. This data is data on the server received and processed from a microcontroller device that is on and directly connected to the load being monitored. The dashboard display will provide the load value measured in real time if the microcontroller device is on and marked with the word "online" appearing on the dashboard menu. The dashboard menu will appear offline if the microcontroller device is off.

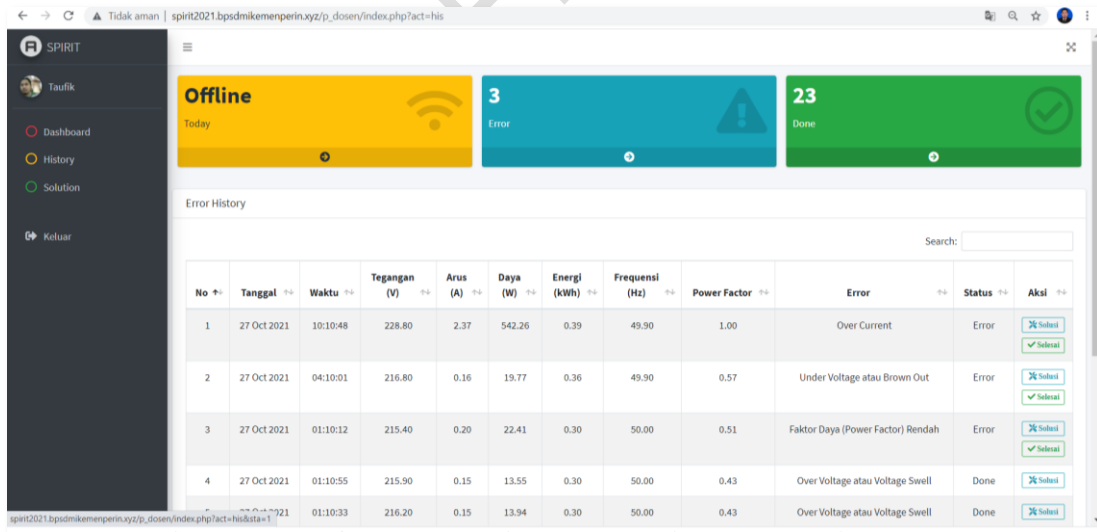

Fig.6. Display menu shows some of the data recorded from electrical energy monitoring.

3. RESULTS AND DISCUSSION

The proposed embedded system's performance is compared to standard power meters. The data collection was carried out to check the overall performance of the embedded system that was made. Measurements were made by comparing the results of direct measurements using amperage pliers compared to the display on the website. Measurements were made using a spinner load. In the spinner, there are two loads. The spinner tool is on in the first load, but the motor is off. In the second loading, the spinner tool and the engine are on.

Table 1. Load Voltage Measurement with Clamp Meter and Device

Number	Clamp Meters Measurement Voltage(Volts)	Website Display Voltage(Volts)	Error (Volt)	Error (%)
1	232	232	0	0
2	232	232	0	0
3	233	232	1	0,43
4	232	233	1	0,43
5	233	232	1	0,43
6	233	233	0	0
7	232	233	1	0,43
8	232	232	0	0
9	232	232	0	0
10	232	232	0	0
Average			0.4	0,17

Table 1 is obtained from the measurements with the spinner load in the condition that the spinner has been turned on, but the spinner motor has not run yet. The spinner already has an on-load in the form of a control component from the spinner. Table 1 shows that the error is 0.17%, meaning that the system's accuracy in acquiring the voltage value is 99.83%.

Table 2. Load Current Measurement with Clamp Meters and Devices

Number	Clamp Meter Measurement Electricity Current (A)	Website Display Electric Current(A)	Error (A)	Error (%)
1	0,0507	0,0400	0,0107	21,1
2	0,0508	0,0400	0,0108	21,2
3	0,0509	0,0400	0,0109	21,4
4	0,0508	0,0400	0,0108	21,2
5	0,0507	0,0400	0,0107	21,1
6	0,0500	0,0400	0,0100	20,0
7	0,0505	0,0400	0,0105	20,7
8	0,0509	0,0400	0,0109	21,4
9	0,0507	0,0400	0,0107	21,1
10	0,0512	0,0400	0,0112	21,8
Average			0,0107	21,1

Table 2 is obtained from the current measurement with the spinner load in the condition that the spinner has been turned on, but the spinner motor has not yet been run. The spinner already has an on-load in the form of a control component from the spinner.

Table 2 shows that the error is 21.1%, meaning that the system's accuracy in acquiring the current value is 78.9%.

Table 3. Load Power Measurement with Clamp Meter and Device

Number	Clamp Meter Measurement Electrical Power (Watt)	Display Website Electrical Power (Watt)	Error (Watt)	Error (%)
1	6,2	7	0,8	12,9
2	6,3	7	0,7	11,1
3	6,3	7	0,7	11,1
4	6,2	7	0,8	12,9
5	6,1	7	0,9	14,7
6	6,3	7	0,7	11,1
7	6,3	7	0,7	11,1
8	6,3	7	0,7	11,1
9	6,3	7	0,7	11,1
10	6,3	7	0,7	11,1
	Average		0,74	11,8

Table 3 is obtained for the power measurement with the spinner load when the spinner has been turned on, but the spinner motor has not run yet. The spinner already has an on-load in the form of a control component from the spinner. Table3 shows that the error is 11.8%, meaning that the system's accuracy in acquiring the power value is 88.2%.

Table 4. Frequency Measurement with Clamp Meters and Devices

Number	Clamp Meter Measurement Frequency (Hz)	Display Website Frequency (Hz)	Error (Hz)	Error (%)
1	49,99	50	0,01	0,02
2	49,99	50	0,01	0,02
3	49,99	50	0,01	0,02
4	49,89	49,90	0,01	0,02
5	49,89	49,90	0,01	0,02
6	49,89	49,90	0,01	0,02
7	49,80	49,80	0	0
8	49,80	49,80	0	0
9	49,80	49,80	0	0
10	49,81	49,80	0,01	0,02
	Average		0,005	0,01

Table 4 is obtained for frequency measurements without loading, which were carried out. Frequency data was also collected with the spinner load when the spinner was turned on and the spinner motor had not been run. The spinner already has an on-load in the form of a control component from the spinner. To ensure that the data is re-tested. Table 4 shows that the error is 0.01%, meaning that the system's accuracy in acquiring the voltage value is 99.99%.

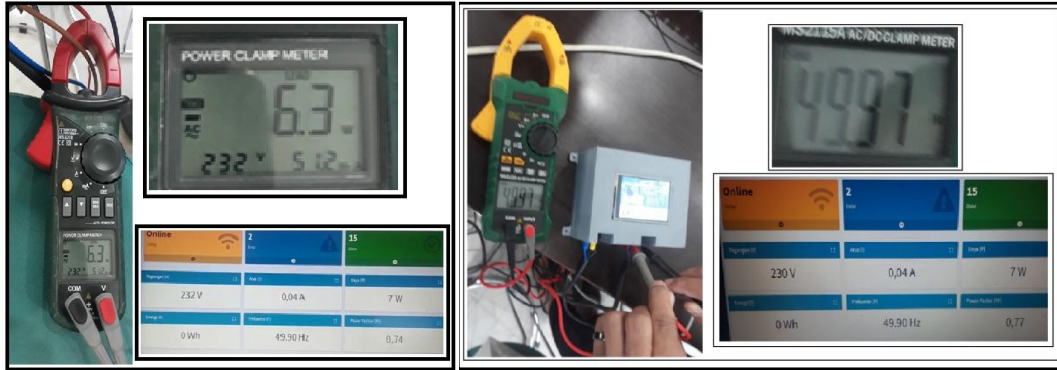

Fig 7. (a) Comparison of Load Power Measurement with Power Clamp Meters and our Devices, (b) Comparison of Frequency Measurements with Clamp Meters and our Devices

Fig.7 (a) shows current, voltage, and power measurements with the spinner load on. The condition of the spinner has been turned on, and the spinner motor has not been started. The spinner already has an on-load in the form of a control component from the spinner. Fig.7 (b) compares frequency measurements with clamp meters and our devices. As we can see, the acquisition of electrical measurement using an integrated acquisition system can be confirmed to work well where the results are not too different from the results of manual measurements.

The quality of monitoring electric power provides the benefits of saving electrical energy. The system device also provides a solution for saving electrical energy by providing information on using electric power (electricity usage management). The existence of electrical details will warn the user or electrician to conduct inspections and take the necessary actions for troubleshooting and saving electrical energy.

4. CONCLUSION

This paper presents research on integrated acquisition embedded systems capable of monitoring electrical energy. The results show that the system is capable of functioning correctly. The integrated acquisition system can operate with great accuracy. The error in using the device compared to direct measurement with a clamp meter at load one is that the voltage is 0.17%, the current is 21.1%, and the power is 11.8%. The error in using the device compared to direct measurement with a clamp meter at a frequency measurement of 0.01%. High errors above 1% occur only when using the device to acquire electric current, which has a smaller current value of 1 A. This is due to receiving the microcontroller in amperes with three digits. System devices can monitor the electrical measurement. The system devices can provide electrical energy-saving solutions by providing information regarding the use of electric power (electricity usage management). This study is expected to contribute to establishing a system that will benefit the government's efforts to preserve energy.

CONSENT

The authors declare that they have no known competing financial interests or personal relationships that could have appeared to influence the work reported in this paper.

ETHICAL APPROVAL

Not Available

REFERENCES

- [1] S. Khan, M. Murshed, I. Ozturk, and K. Khudoykulov, "The roles of energy efficiency improvement, renewable electricity production, and financial inclusion in stimulating environmental sustainability in the Next Eleven countries," *Renewable Energy*, vol. 193, pp. 1164–1176, 2022, doi: 10.1016/j.renene.2022.05.065.
- [2] C. S. Tan, K. Maragatham, and Y. P. Leong, "Electricity energy outlook in Malaysia," *I.O.P. Conference Series: Earth and Environmental Science*, vol. 16, no. 1, p. 012126, Jun. 2013, doi: 10.1088/1755-1315/16/1/012126.
- [3] Y. Himeur *et al.*, "Techno-economic assessment of building energy efficiency systems using behavioral change: A case study of an edge-based micro-moments solution," *Journal of Cleaner Production*, vol. 331, p. 129786, Jan. 2022, doi: 10.1016/j.jclepro.2021.129786.
- [4] S. Khan, M. Murshed, I. Ozturk, and K. Khudoykulov, "The roles of energy efficiency improvement, renewable electricity production, and financial inclusion in stimulating environmental sustainability in the Next Eleven countries," *Renewable Energy*, vol. 193, pp. 1164–1176, 2022, doi: 10.1016/j.renene.2022.05.065.
- [2] C. S. Tan, K. Maragatham, and Y. P. Leong, "Electricity energy outlook in Malaysia," *I.O.P. Conference Series: Earth and Environmental Science*, vol. 16, no. 1, p. 012126, Jun. 2013, doi: 10.1088/1755-1315/16/1/012126.
- [3] Y. Himeur *et al.*, "Techno-economic assessment of building energy efficiency systems using behavioral change: A case study of an edge-based micro-moments solution," *Journal of Cleaner Production*, vol. 331, p. 129786, Jan. 2022, doi: 10.1016/j.jclepro.2021.129786.
- [4] IEA, "https://www.iea.org/energy-system/buildings," 2023. <https://www.iea.org/energy-system/buildings>.
- [5] EIA, "https://www.eia.gov/tools/faqs/faq.php?id=97&t=3," 2023. .
- [6] E.R.L., "https://erl.scholasticahq.com/article/33899-gmm-approach-to-residential-electricity-consumption-in-indonesia," 2023. <https://erl.scholasticahq.com/article/33899-gmm-approach-to-residential-electricity-consumption-in-indonesia> (accessed Jul. 28, 2023).
- [7] Y. Qin, Z. Xu, X. Wang, and M. Škare, "Green energy adoption and its determinants: A bibliometric analysis," *Renewable and Sustainable Energy Reviews*, vol. 153, p. 111780, 2022, doi: 10.1016/j.rser.2021.111780.
- [8] M. Humayun, M. S. Alsaqer, and N. Jhanjhi, "Energy Optimization for Smart Cities Using IoT," *Applied Artificial Intelligence*, vol. 36, no. 1, p. 2037255, Dec. 2022, doi: 10.1080/08839514.2022.2037255.
- [9] A. Behzadi, A. Gram, E. Thorin, and S. Sadrizadeh, "A hybrid machine learning-assisted optimization and rule-based energy monitoring of a green concept based on low-temperature heating and high-temperature cooling system," *Journal of Cleaner Production*, vol. 384, p. 135535, 2023, doi: 10.1016/j.jclepro.2022.135535.
- [10] Z. Chen, C. B. Sivaparthipan, and B. Muthu, "IoT based smart and intelligent smart city energy optimization," *Sustainable Energy Technologies and Assessments*, vol.

- 49, p. 101724, Feb. 2022, doi: 10.1016/j.seta.2021.101724.
- [11] S. Panda *et al.*, "Residential Demand Side Management model, optimization and future perspective: A review," *Energy Reports*, vol. 8, pp. 3727–3766, Nov. 2022, doi: 10.1016/j.egy.2022.02.300.
- [12] M. Noro and F. Busato, "Energy Saving, Energy Efficiency or Renewable Energy: Which Is Better for the Decarbonization of the Residential Sector in Italy?," *Energies*, vol. 16, no. 8, p. 3556, Apr. 2023, doi: 10.3390/en16083556.
- [13] M. S. Tokarik and R. C. Richman, "Life cycle cost optimization of passive energy efficiency improvements in a Toronto house," *Energy and Buildings*, vol. 118, pp. 160–169, Apr. 2016, doi: 10.1016/j.enbuild.2016.02.015.
- [14] N. Abdou, Y. EL Mghouchi, S. Hamdaoui, N. E.L. Asri, and M. Mouqallid, "Multi-objective optimization of passive energy efficiency measures for net-zero energy building in Morocco," *Building and Environment*, vol. 204, p. 108141, Oct. 2021, doi: 10.1016/j.buildenv.2021.108141.
- [15] R. Abadia, M. C. Rocamora, J. I. Corcoles, A. Ruiz-Canales, A. Martinez-Romero, and M. A. Moreno, "Comparative analysis of energy efficiency in water users associations," *Spanish Journal of Agricultural Research*, vol. 8, no. S2, p. 134, Nov. 2010, doi: 10.5424/sjar/201008S2-1356.
- [16] M. U. Saleem, M. R. Usman, M. A. Usman, and C. Politis, "Design, Deployment and Performance Evaluation of an IoT Based Smart Energy Management System for Demand Side Management in Smart Grid," *IEEE Access*, vol. 10, pp. 15261–15278, 2022, doi: 10.1109/ACCESS.2022.3147484.
- [17] B. Zhou *et al.*, "Smart home energy management systems: Concept, configurations, and scheduling strategies," *Renewable and Sustainable Energy Reviews*, vol. 61, pp. 30–40, Aug. 2016, doi: 10.1016/j.rser.2016.03.047.