

Review Article

ARTIFICIAL INTELLIGENCE AND SERICULTURE

ABSTRACT

The term Artificial intelligence is used to describe any machine or system having the intelligence of human *i.e.*, the ability to learn, adopt and apply their knowledge to give a result similar to human being. In the current environment, producing high-quality silk is crucial to reaching sustainability by 2030. The identification of the barriers preventing the increase of silkworm production is limited by the traditional technique. With the development in the field of artificial intelligence, it is providing many benefits to sectors like sericulture where, the expert systems are being used to solve many problems like disease and pest, gender classification, changing environmental conditions in both host plant as well as silkworm sector. For the sericulture industry to thrive amidst a changing world, it must keep pace with evolving challenges. This necessitates emphasizing the integration of intelligent tools. This approach underscores the importance of leveraging technology for a prosperous future and economy.

Key words: Artificial Intelligence, voice recognition, image processing, Sericulture, pest and disease, gender classification, host plant

Comment [DV1]: Italicise

Comment [DV2]: Rewrite as "it provides benefit to the sericulture sector"

Comment [DV3]: Add "in silkworm"

Comment [DV4]: I should be in small letter "i"

Comment [DV5]: Capitalise first word

1. INTRODUCTION

"Sericulture" derives from "Su" (Si), meaning silk, and entails the complete process of cultivating silkworms, growing their food plants, and producing silk. This agro-industry is economically beneficial and integrates various activities that have a profound impact on the economic prosperity of rural areas. Sericulture merges agricultural activities like silkworm rearing and food plant cultivation with industrial methods for silk production, which includes breeding silkworms to obtain eggs and cocoons. In India, sericulture—specifically the rearing of silkworms and subsequent production of silk fiber—has become a promising rural industry. This is attributed to its short gestation period, low initial costs, significant employment opportunities, and high potential for returns on investment. Over the course of time, this industry is evolving to meet the demands of the market, new advances in technology, and concerns for the environment. However, currently sericulture has become less about making silk and more about adopting innovative technologies, ecological methods, and responding to the needs of a worldwide market. Sustainable sericulture is now more important than ever as environmental awareness expands. The industrial process of producing silk is changing these days due to the integration of cutting-edge technologies including cloud computing, big data, artificial intelligence (AI), and the

Comment [DV6]: Provide references for the statement

Comment [DV7]: Add references

Internet of Things (IoT). The primary objective of this paper is to discuss artificial intelligence's application in the sericulture industry.

2. ARTIFICIAL INTELLIGENCE

Artificial Intelligence defined by Grewal (2014) as “the mechanical simulation system of collecting knowledge and information and processing intelligence of universe: (collecting and interpreting) and disseminating it to the eligible in the form of actionable intelligence”. Simply put, artificial intelligence refers to machines' capacity to emulate human behavior. These machines can think, learn, and act like humans, applying their knowledge in real-time to solve problems. The well-known examples of artificial intelligence are iPhone Siri, amazon Alexa, IBMs Deep Blue, Sophia the humanoid robot etc.

Comment [DV8]: Use abbreviated form like AI

Comment [DV9]: italicise

MACHINE LEARNING

Machine learning fundamentally revolves around the idea of learning from experience and examples, forming a subset of artificial intelligence. It employs algorithms and statistical techniques that enable machines to learn from data, generate results based on their training and testing, and progressively improve their performance as they encounter more data and experience. In the same way that a child is taught to walk, talk, run, read, and write, a computer is taught everything to become artificially intelligent through machine learning, language, and commands. Machine learning makes use of several technologies such as computer vision, robotics, image processing, and symbolic learning. The computer automatically evaluates tens of thousands of samples, generates an algorithm, and then enhances itself through machine learning once it reaches the intended result. Human inputs are required for the machine to learn. The machine is taught by the human that for this specific activity, you should do this and that its output should be what we desire, and then the human leaves the machine to learn automatically from its prior experiences. Therefore, the fundamental data bases (database) and the cycles or processes used to fill these data bases into the machines should be reliable, secure, and up to date. The qualities of artificial or machine intelligence include mobility, understanding, forecasting modification, spontaneous decision-making, and constant learning (Mohammed, 2019).

Comment [DV10]: rewrite the sentence

Comment [DV11]: Give space before The

Issues facing the sericulture industry include preserving humidity and temperature, reducing the number of workers needed to count eggs, and separating sex, among others. Constant counting can cause vertigo, migraines, and eye strain in addition to reducing the precision of the results. In order to overcome these challenges in the field of sericulture today, computer-based approaches such as Artificial Neural Networks (ANN), Single Shot Multi-Box Detector (SSD), Convolutional Neural Network (CNN), the Internet of Things (IoT), Artificial Intelligence (AI) methodologies, and image processing algorithms must be employed. In the modern sericulture industry, computer-based technologies are significantly more important to reaching tangible goals. It's also used in the sericulture industry for counting, identifying, and classifying fruits, flowers, leaves, sicknesses, and silkworm eggs, among other things. In the past, researchers have used deep learning (VGG16, ResNet50, and Inception V3), machine learning (ANN, CNN, Fast CNN, Faster CNN, SSD, Yolo V3, KNN, SVM), and image processing (Violo) techniques to efficiently count, detect, and classify silkworm eggs at low cost. This is because early detection of

Comment [DV12]: Add "in"

Comment [DV13]: Provide space before "in"

Comment [DV14]: Provide space before "in"

unhealthy and healthy silkworm eggs leads to an estimated profit. An Agritech start-up in Bengaluru is connecting the entire silk industry supply chain with digital technologies, enabling sericulture farmers to get better prices for their produce and guaranteeing the quality of cocoons and yarn for reelers, weavers, and retailers. A range of techniques, such as human approaches, artificial neural networks (ANN), the internet of things (IOT), artificial intelligence (AI), and image processing algorithms, are used to count silkworm eggs (Ngo *et al.*, 2021; Prathan *et al.*, 2019).

Comment [DV15]: Provide space before 'an'

Comment [DV16]: Rewrite the paragraph

Comment [DV17]: Provide space before 'a'

3. ARTIFICIAL INTELLIGENCE IN SERICULTURE

The world silk industry is gaining importance day by day due to the high demand of silk in market. Silk is a natural protein fiber which are produced by many insects but the main commercial silk is produced by 4 species of insect under order lepidoptera and they are *Bombyx mori* (mulberry), *Samia ricini* (eri), *Antheraea assamensis* (muga), *Antheraea mylitta* and *Antheraea proylei* (tasar). The silkworm has 4 life stages viz. egg, larva, pupa and adult, each stage being equally important for a better commercial outcome.

Comment [DV18]: Remove underline as it is already written in italics

Comment [DV19]: Remove underline as it is already written in italics

Comment [DV20]: Remove underline as it is already written in italics

Comment [DV21]: Remove underline as it is already written in italics

Comment [DV22]: Remove underline as it is already written in italics

The sericulture comprises of two parts, one is host plant production and the other is silkworm rearing, both are interdependent. Development in both the sector equally will bring better result to the industry and application of artificial intelligence is now showing the potential of how far the development can go in future. Here in this paper, some of the very few application of artificial intelligence is discussed in a brief manner.

Comment [DV23]: Italicise

Comment [DV24]: Add "of"

Comment [DV25]: Write as "applications"

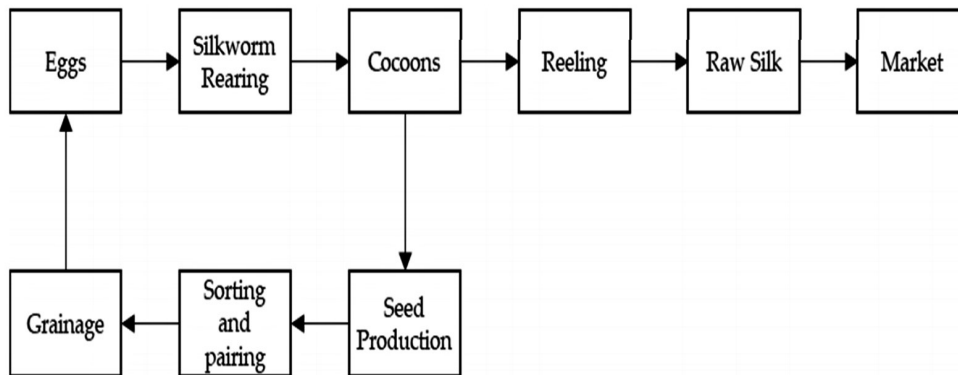

Fig 1: Silkworm commercial process flow diagram (Raj *et al.*, 2019)

Comment [DV26]: Remove space

3.1. ARTIFICIAL INTELLIGENCE IN HOST PLANT PRODUCTION

Out of the four life stages of silkworm, the larval stage is the feeding stage that feeds on the host plants and based on host plant the silkworms are classified into monophagous i.e., mulberry and polyphagous i.e., eri, muga and tasar. Quality and quantity of feeds the silkworm gets during its larval period greatly influence the silkworm growth and development, their health and also the production of quality and quantity of silk which is the final product.

Comment [DV27]: italicise

Comment [DV28]: italicise

Prediction of crop yield by observing the nutritional data of the soil can be achieved by using artificial intelligence techniques. Using machine learning models like regression models, the nutritional data of soil can be computed with which the leaf yield of a host plant can be predicted, which in turn provides a farmer with better plans for future rearing of silkworm. Experimentation on soil sample for different soil parameter data like soil macro and micro-nutrients, soil pH and electrical conductivity, organic carbon content etc. which greatly affects the plant growth, was conducted through AI model consisting 3 regression model viz. Multiple Linear Regression, Ridge Regression and Random Forest Regression. Such AI models can predict the yield which improves the rearing efficiency (Srikantiah and Deeksha, 2021).

Comment [DV29]: remove space

Comment [DV30]: italicise

Comment [DV31]: italicise

Disease is another biotic factor influencing the yield of a crop by infesting the crops causing crop failure. Diseases like leaf spot, leaf rust, mildew, leaf and root rot, leaf blast, seedling and leaf blight etc. are some of the very few diseases commonly seen in host plant fields. To identify such diseases, expert observation and continuous monitoring is required with a team of experts which is not always possible for farmers. Hence automatic disease detection by expert systems comes in use in such cases which provides more accuracy compared to traditional system. AI models based on image processing like Convolutional Neural Network is one of the most successful models that helps in accurate disease recognition where the image with diseased leaf is fed to the model and the different layers of the neural network system will work on that image layer by layer to properly identify the disease attacking the leaves. It can help providing the farmers knowledge about the type of disease infesting their crops (Hema *et al.*, 2019).

Comment [DV32]: italicise

Comment [DV33]: use abbreviated form as CNN

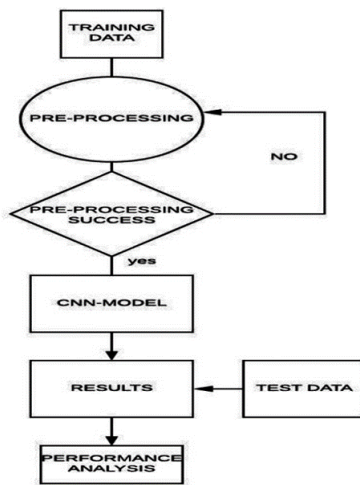

Fig 2: Proposed system architecture (Hema *et al.*, 2019)

Expert systems for detection of disease symptoms, spread of disease and even knowledge about favorable conditions for disease and images of diseases, are being

developed. The user can ask any query and the system will draw conclusions from the knowledge base which is obtainable from books, magazines, knowledgeable persons etc. and display the conclusion to the user (Salman and Naser, 2019). Another example of AI model based on image processing is model designed with You Only Look Once (YOLO) algorithm that can effectively classifies leaf diseases and detect the disease for further treatment (Reddy and Deeksha, 2021). Controlling the disease at an early stage is very much essential for achieving higher productivity which also requires skilled detection.

Comment [DV34]: italicise

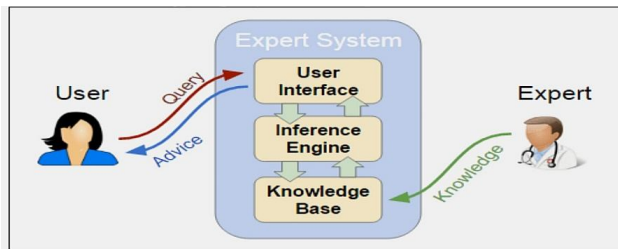

Fig 3: Main components of expert system (Salman and Naser, 2019)

Comment [DV35]: remove empty space

3.2. ARTIFICIAL INTELLIGENCE IN SILKWORM SEED PRODUCTION

Silkworm seeds can be hibernating or non-hibernating, sensitive to light and vibration. Some of the crucial information about eggs like date of oviposition, probable date of hatching, hibernating or non-hibernating, free from any disease or not are mandatory to provide along with the eggs being transported for proper planning for rearing. Sometimes, the eggs are induced with hibernation artificially or break the hibernation artificially for the rearing to coincide with availability of feeding.

For these to achieve, artificial intelligence helps obtaining the developmental stage of the embryo in a non-destructive manner. Experimentations regarding recognition of the developmental stages of an embryo inside egg shell was done using terahertz imaging technology, where the terahertz images from 8 days prior to hatching are fused with optical images of same duration to get accurate results of the developmental stage of the embryo. This model not only gave result in THz images but also less time consuming with high recognition accuracy (Xiong *et al.*, 2021). This helps in predicting date and time of hatching, hibernation period, initiation and termination period of hibernation etc.

Comment [DV36]: remove extra space

Comment [DV37]: italicise

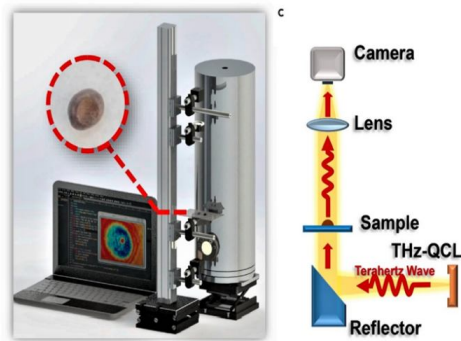

Fig 4: THz QCL video imaging system

Comment [DV38]: Remove extra space

3.3. ARTIFICIAL INTELLIGENCE IN SILKWORM REARING (Xiong *et al.*, 2021)

Out of the four stages in silkworm life cycle, the larval stage is the feeding stage. The quality and quantity of cocoon or silk production depends largely on this larval stage. This larval stage is the most vulnerable stage to any pest or disease attack and also the most sensitive stage to any fluctuation in ideal environmental condition.

Therefore, it is important to prioritize maintaining optimal environmental conditions to enhance productivity. Achieving and sustaining these conditions can be facilitated through an AI-powered automated smart sericulture facility. This facility integrates advanced monitoring systems and sensors to promptly detect any deviations from the optimal rearing environment and automatically take corrective actions to restore it (Nithin *et al.*, 2021).

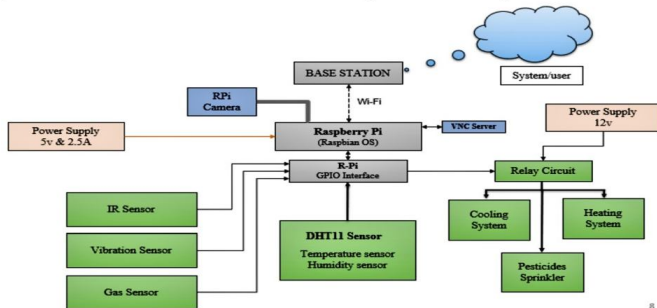

Fig 5: The automated smart sericulture plant system architecture (Nithin *et al.*, 2021)

Environmental factors strongly influence disease incidence in silkworms, causing significant threats like flacherie, grasserie, muscardine, and pebrine. These diseases can devastate sericulture, leading to crop losses. Optimal environmental conditions are crucial for larval growth. To mitigate such risks, early disease warning systems utilizing AI can predict outbreaks by analyzing environmental variables. In 2021, a mobile-based system developed by North Eastern Space Applications Centre and CMERTI provided early warnings for flacherie in Muga silkworms, using temperature, humidity, and anthropogenic data to help farmers take timely precautions. (Goswami *et al.*, 2021).

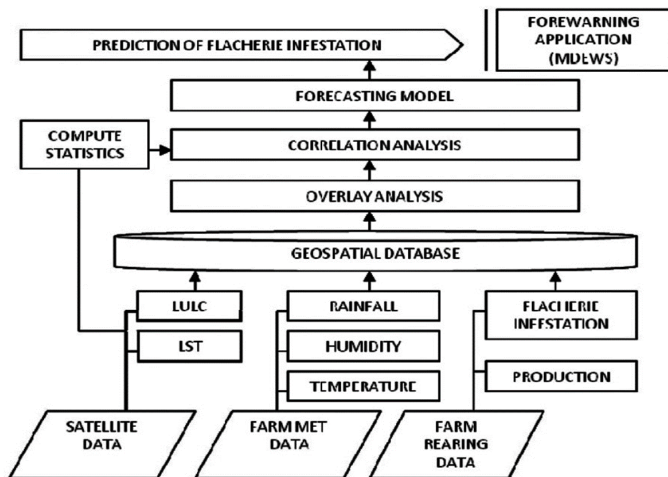

Fig 6: Disease forecasting system methodology flow chart (Goswami *et al.*, 2021)

In addition to diseases, pests pose a significant threat to sericulture, leading to substantial crop and economic losses. Pests such as ants, uzi fly, and dermestid beetle attack silkworms, often resulting in their death and reduced harvest yields. Continuous surveillance of pests is challenging through manual methods but can be effectively managed using artificial intelligence. AI models equipped with deep-learning algorithms such as Inception ResNet, Inception-V3, VGG-16, and VGG-19 can be trained to detect invasive species in rearing houses, enabling consistent monitoring (Prמודh and Thippesha, 2022).

3.4. ARTIFICIAL INTELLIGENCE IN SILKWORM GENDER CLASSIFICATION

Silkworm gender can be visually classified during larval, pupal, and adult stages. Certain sex-specific traits, like color variations in eggs, larvae, and pupae, exist but have not been commercially utilized in India for various reasons. Gender classification is crucial in sericulture for breeding and silk production. Male silkworms are typically preferred for commercial silk production due to their higher silk content per cocoon and lower leaf consumption compared to females. This distinction is essential for optimizing silk production and managing resources effectively.

There are two ways of classification of gender viz. destructive and non-destructive way. Gender classification of pupae traditionally requires skilled visual observation without damaging the cocoon, which is crucial since silk is the final product. Destroying cocoons for gender identification isn't economically feasible. The classical method relies on the size difference as females are generally larger, but it has limitations. Hence, AI-based approach uses image processing and load sensors to non-destructively classify pupae by visually comparing cocoons and considering their weight, effectively separating male and

Comment [DV39]: Remove extra space

Comment [DV40]: italicise

female cocoons (Raj *et al.*, 2019). X-ray imaging offers a non-destructive method for cocoon gender separation. Using an AI-based system, it compares the shape features of the pupa inside the cocoon with computed shape features of both male and female pupae and cocoons. This process classifies the gender without the need to cut open the cocoon (Thomas and Thomas, 2022). Such systems can easily identify the sex with higher accuracy using less time and labour which is the main aim for using artificial intelligence *i.e.*, less time and labour consuming.

Comment [DV41]: italicise

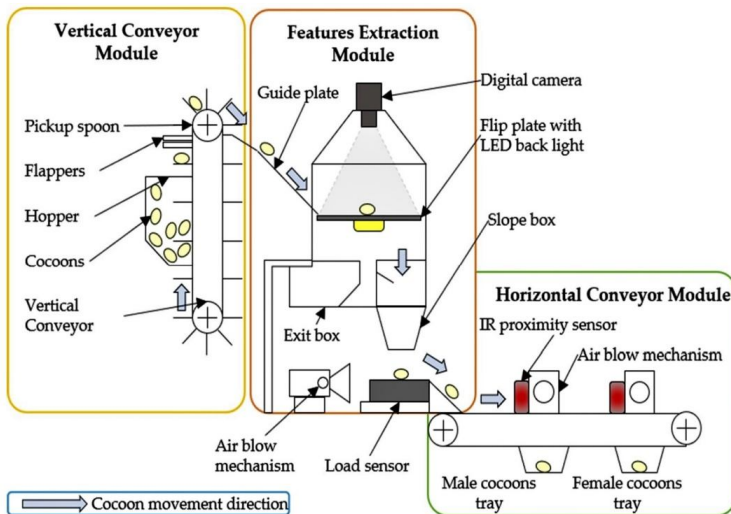

Fig 7: Schematic diagram of cocoon separating machine (Raj *et al.*, 2019)

4. CONCLUSION

Here, we concluded that in order to produce high-quality silk filament, it becomes essential to constantly track silkworms at every stage of their development. If not and many diseases may arise that are not even visible or observable because they do not exhibit any symptoms; instead, they stop the silkworms' life cycle, growth, and development, and are only discovered after a worm dies among the population of silkworms in the raised tray. The main aim of artificial intelligence is to reduce time and labour with higher accuracy in decision making. If suitably developed and implemented, it has the capability to revolutionize the world. Artificial Neural Networks, the Internet of Things, Artificial Intelligence approaches, and Image Processing Algorithms are just a few examples of the computer-based technological interventions that ensure the safe and healthy growth of the silk worms with modulated temperature control, disease detection, and protection. As artificial intelligence has shown how far its potentiality lies in the future, it will certainly help the sericulture to grow to a whole new level while coping up with the challenges to survive and flourish in the future.

Comment [DV42]: write in a crisp way

References:

- Goswami, J.; Gogoi, D. K.; Rashid, N.; Handique, B. K.; Subrahmanyam, G.; Bora, P. P.; Das, R. and Raju, P. L. N. (2021). Development of a Muga disease early warning system – a mobile-based service for seri farmers. *CURRENT SCIENCE*.**121**(10): 1328-1334
- Grewal, D. S. (2014). A Critical Conceptual Analysis of Definitions of Artificial Intelligence as Applicable to Computer Engineering. *IOSR Journal of Computer Engineering*. **16**(2): 09-13
- Guzman, A.L. (2017). Making AI safe for humans: A conversation with Siri. In R. W. Gehl & M. Bakardjieva (Eds.), *Socialbots and their friends: Digital media and the automation of sociality*. 69-85
- Hema, D. D.; Dey, S.; Krishabh and Saha, A. (2019). Mulberry Leaf Disease Detection using Deep Learning. *International Journal of Engineering and Advanced Technology*. **09**(01): 3366-3371
- Mohammed Z. (2019). Artificial intelligence, definition, ethics and standards. *Electronics and communications: Law, standard and practice*. p. 1-10
- Ngo, T. D., Bui, T. T., Pham, T. M., Thai, H. T., Nguyen, G. L., & Nguyen, T. N. (2021). Image deconvolution for optical small satellite with deep learning and real-time GPU acceleration. *Journal of Real-Time Image Processing*. **18**(5), 1697-1710
- Nithin, H. V.; Naikwadi, M. B.; Meghana, G. H.; Jyothi, B. K. and Kamala Priya, V. L. (2021). AUTOMATED SMART SERICULTURE PLANT: AN IOT & AI BASED SYSTEM APPROACH. *International Research Journal of Modernization in Engineering Technology and Science*. **03**(07): 781-785
- Prathan, S., Auephanwiriyaikul, S., Theera-Umpon, N., & Marukatat, S. (2019, January). Image-based silkworm egg classification and counting using counting neural network. *Proceedings of the 3rd International Conference on Machine Learning and Soft Computing* (pp. 21-26)
- Pramodh, B. R. and Thippesha, D. (2022). Deep Learning-Based Pest Surveillance System for Sericulture. *Journal of Research in Engineering and Applied Sciences*. **07**(01): 277-280
- Raj, A. N. J.; Sundaram, R.; Mahesh, V. G. V.; Zhuang, Z. and Simeone, A. (2019). A Multi-Sensor System for Silkworm Cocoon Gender Classification via Image Processing and Support Vector Machine. *Sensors*. **19**
- Reddy, M. P. and Deeksha, A. (2021). Mulberry leaf disease detection using YOLO. *International Journal of Advance Research, Ideas and Innovations in Technology*. **07**(03): 1816-1821

- Salman, F. M. and Naser, S. S. A. (2019). Expert System for Castor Disease and Diagnosis. *International Journal of Engineering and Information Systems*. **03**(03): 1-10
- Srikantaiah, K. C. and Deeksha, A. (2021). Mulberry Leaf Yield Prediction Using Machine Learning Techniques. *Atlantis Highlights in Computer Sciences*. **04**: 393-398
- Thomas, S. and Thomas, J. (2022). Non-destructive silkworm pupa gender classification with X-ray images using ensemble learning. *Artificial Intelligence in Agriculture*. **06**: 100-110
- Toosi, A.; Bottino, A.; Saboury, B.; Siegel, E. and Rahmim, A. (2021). A BRIEF HISTORY OF AI: HOW TO PREVENT ANOTHER WINTER. *PET Clinics*. **16**(04): 449-469
- Xiong, H.; Cai, J.; Zhang, W.; Hu, J.; Deng, Y.; Miao, J.; Tan, Z.; Li, H.; Cao, J. and Wu, X. (2021). Deep learning enhanced terahertz imaging of silkworm eggs development. *iScience*. **24**

UNDER PEER REVIEW