

Original Research Article

Design and Implementation of an IoT Based Smart Home Monitoring and Control System Using NodeMCU

ABSTRACT

This paper presents the design and implementation of an IoT based smart home monitoring and control system using a NodeMCU microcontroller. The system allows the user to remotely control electrical appliances through a web-based user interface dashboard. The system uses sensors DHT11 to monitor the temperature and humidity of the home and MQ 2 to monitor the air quality and alerts the user in case smoke or fire is detected. Various HTML scripts are executed to develop a web-based dashboard interface where the user interacts with the system. When connected to the internet, the system generates an IP address that is used to access the web page for monitoring and control of various house appliances. A coverage range of up to 67.050 meters was achieved by the system using the on-board Wi-Fi module on the NodeMCU. The system provides energy efficiency, home security, and centralized remote control of appliances thereby minimizing human efforts, energy losses and providing a friendly and secure home.

Keywords: NodeMCU, IOT, Smart home, Webserver dashboard

1. INTRODUCTION

Smart home automation systems are becoming popular in recent years as the rapid development in the Internet of things (IoT) technologies makes interconnections and remote control of appliances much easier. Smart home automation systems enable users to conveniently control and monitor their home appliances. In addition, they enhance efficient energy use and minimize energy losses [1].

The IoT comprises the network of physical objects (things) that are embedded with sensors and software for the purpose of interconnecting devices over the internet. Another significant use of the IoT technologies is automation. By utilizing sensors and actuators, appliances can be controlled and environmental condition can be monitored [1]. With the IoT technology, the "smart home," also known as "house automation," aims to make domestic tasks more convenient, safe, and cost-effective [2].

Generally, home automation systems include main components which are [1]: 1. User interface: a device that can receive commands to control a system, such as a phone, computer, or display. 2. Transmission method: wireless (such as radio waves, infrared, Bluetooth or GSM). 3. Central Controller: It is a hardware interface that sends the control signals and communicates with the user interface.

Although the idea of home automation has been around for a while, its technical difficulties, high price, incompatibility and range issues have stopped it from being commonplace in home automation. However, by addressing these challenges through IoT wireless

technologies and the use of smartphone applications, the prospect of home automation systems will improve.

This paper proposes a user-friendly dashboard interface for control of home appliances and monitoring of temperature, humidity and air quality using a NodeMCU and a few peripheral components.

1.1 Related Literature

Several systems have been developed for smart home automation as can be found in literature [3]-[35]. Some of these systems that are relevant to this paper are reviewed in this section and the limitations in such systems have been highlighted. In [9], a smart home (SH) automation using Bluetooth and GSM module was proposed. The work aimed to assist handicapped and elderly people to control home appliances from remote places. Bluetooth was used to control appliances indoor and GSM to control appliances outdoor. Bluetooth can reduce system costs because most cellphones and laptops have this built-in application. Users can monitor and control appliances remotely by sending SMS through GSM. However, such systems have limitations in both cases. Bluetooth has a limited range and data rate, while GSM is expensive due to SMS costs.

[12] Proposed a smart home automation based on sensor technology that can automatically control home appliances using Android-based smartphone as a remote controller. The authors utilized Raspberry Pi as the microcontroller and Bluetooth as the communication protocol. Wi-Fi was used to connect the smartphone to the Raspberry Pi controller. All sensors update their data to a local server via Raspberry Pi. However, the user cannot access the server and cannot directly use the smartphone to send the commands to the Raspberry Pi controller outside the Bluetooth range.

In [13], a home automation and environmental monitoring system was developed using Arduino Mega 2560 microcontroller with Bluetooth module. Several sensors and switches were used to control home appliances through a web-based application. However, Arduino Mega is more expensive than NodeMCU, and the use of Bluetooth is unsuitable for smart home application due to its limited features.

A Wi-Fi-based home automation system was designed and implemented by [14]. The developed prototype allowed users to control and monitor a home through Wi-Fi by using Arduino Mega integrated with Android-based application known as Virtuino. However, the prototype had limited connectivity, can only perform local control, and the remote control of the developed system should be enabled based on IoT to allow users to control it using a webserver even when they are not around their home. A similar system using Arduino Mega with Internet of things (IoT) was presented by [15]. The interconnected system consisting of an Arduino microcontroller was used to connect to an Ethernet shield, which was connected to a modem with Internet connection. A relay was connected to the device for control while a dashboard through a HTML page with an assigned IP address was used. However, the system did not consider home monitoring and the system was not implemented.

Reference [16] introduced a web-based Internet of things (IoT) architecture using GSM to implement smart home system and presented a GSM-based control system. This work suggested a structure to enable users to monitor and control smart devices through the Internet, where the users give commands through the web, and the user input is converted to GSM-SMS commands. The proposed structure creates an interface between the SH and users through the Internet and GSM and provides a GSM-based wireless connection from

the web server to the SH. These commands are sent to the integrated system module, which is placed anywhere and can be directly connected to the devices through GSM network. In addition, the module is controlled through an Internet of things (IoT) agent by the GSM network. The user commands are executed and analyzed using a microcontroller to control home appliances, and sends an acknowledgment to the user. The prototype collects and transmits data through GSM– SMS.

Reference [17] introduced an Internet of things (IoT)-based system for efficient energy management of devices and security. The main concept of this work is to control home appliances using smartphones through Wi-Fi as the connection protocol, which provides the information on the required software and hardware components. The Internet of things (IoT) structure used acts such that all the devices are connected to a smart central control system, which is linked to the switch for each connected device and thus, enables access to each individual device.

In this work, we proposed a smart home automation system using normal web server and a Wi-Fi module such that appliances can be monitored and controlled wirelessly by sending command to the microcontroller (ESP8266) via the web server dashboard. The appliances to be control by the prototype system include indoor lighting point, outdoor lighting point, power plug, and a fan. The system is also equipped with temperature, humidity and smoke sensor such that the status of the environment is monitored. One key advantage of the system is the user-friendly webserver dashboard feature that allows it to be used in any computer system or mobile phone that can access the internet.

2. MATERIAL AND METHODS

The SH system is built around the NodeMCU which serves as the main control unit. Peripheral devices used are the temperature and humidity sensor, gas sensor, relay assembly and the loads all of which are controlled through the webserver dashboard. The microcontroller is programmed to communicate with the webserver and the other part of the system. To control and monitor home appliances the Internet Protocol (IP) address generated by the microcontroller is copied unto a browser where it will open the system dashboard through which it displays the present condition of the appliances/environment. The communication channel used is Wi-Fi. The system block diagram is shown in Fig. 1 where the different hardware components are illustrated

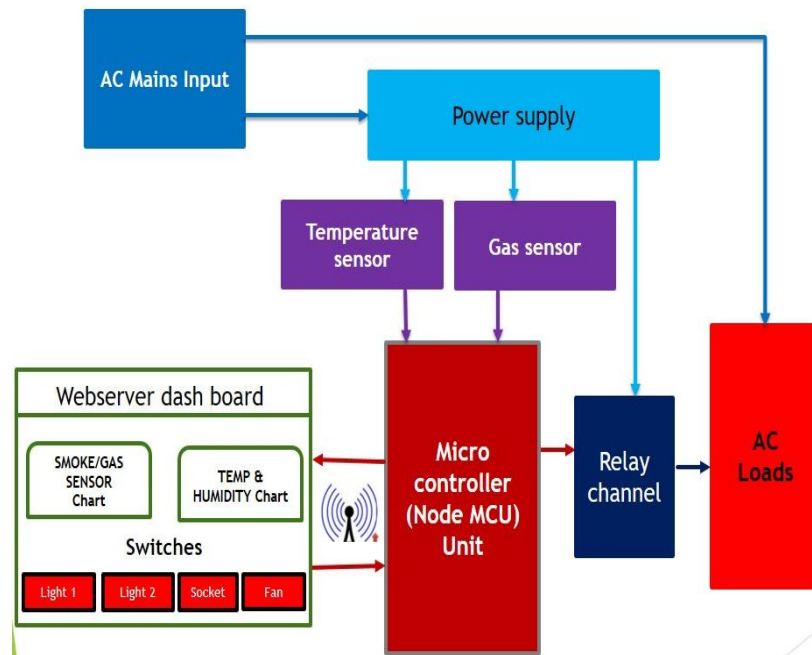

Fig. 1 Block diagram of the smart home automation system

2.1 Hardware Components of the System

The main hardware components used in the SH automation system are shown in Fig. 2. Each of the components are listed below with a brief description of their functions.

- (a) **ESP8266 (NodeMCU):** is an open-source firmware and development kit that helps in prototype or building Internet of things (IoT) products. In addition to its CPU, RAM, and operating system, it contains and a Wi-Fi module that can easily connect to components, such as sensors and actuators.
- (b) **DHT11 Sensor Module:** measures both the temperature and humidity in an individual distinctive mode. The module ensures high reliability and excellent long-term stability due to the exclusive digital signal acquisition with respect to the sensing technology. [8].
- (c) **MQ Gas sensor Module:** MQ-2 gas sensor or detector is an electronic detector used for sensing the concentration of gases within the air like LPG, Propane, methane, hydrogen, alcohol, smoke and carbon monoxide gas. It contains a sensing material whose resistance changes when it comes in touch with the gas. This variation within the value of resistance is used for the detection of gas [ref].
- (d) **Relay Module:** a four-channel relay module contains four relays and the associated driver circuitry which makes interfacing with a microcontroller or a sensor easy. There are two terminal blocks with six terminals each, and each block is shared by two relays. The terminals are screw type, which makes connections to mains wiring easy and changeable. The four relays on the module are rated for 5V, which means the relay is activated when there is approximately 5V across the coil. The contacts on each relay are specified for 250VAC and 10A in each case, as marked on the body of the relays.

(e) **AC-DC 5V Precision Buck Converter:** is a Switch Mode Power Supply Module. It can supply 5V DC from 220V AC and has a power rating of 3.5W. This makes it perfect for small projects that needs a 5V supply from mains.

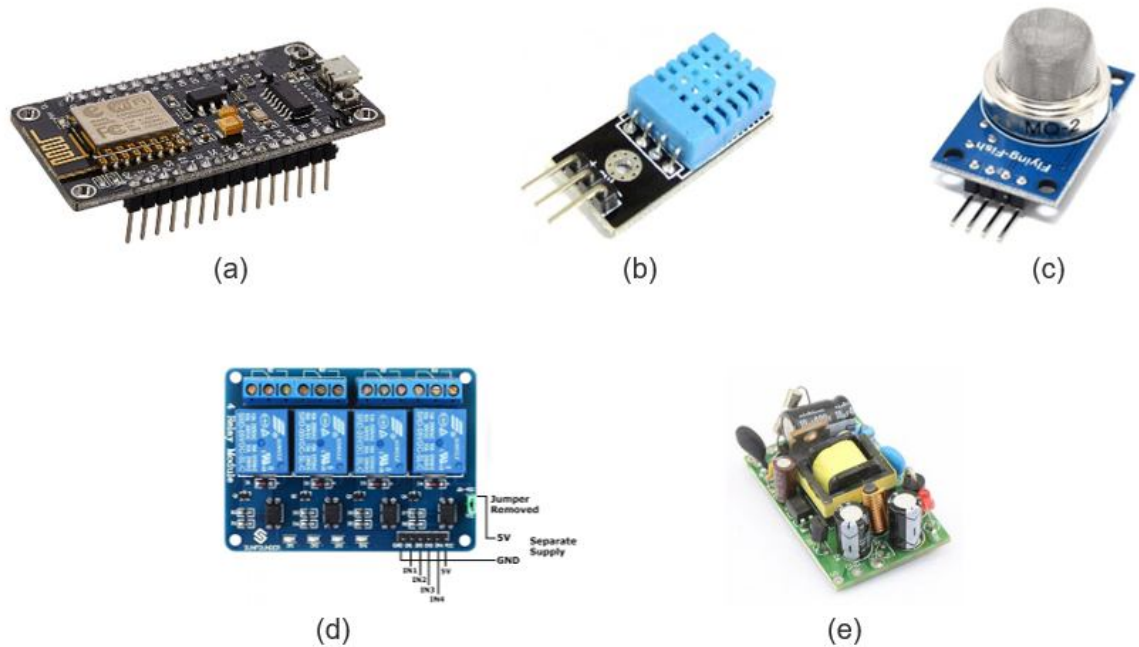

Fig. 2 Hardware components of the system (a) NodeMCU Esp8266 (b) DHT11 Sensor module (c) MQ-2 gas sensor module (d) Relay module (e) Power supply unit

2.2 Software Components of the System

- (a) **Webserver Dashboard:** A web server dashboard is created using various HTML scripts, to allow users to interact with the system. The system can monitor the temperature and humidity of the environment via the web server dashboard and control the actuator unit smartly using smartphones, tablets, or computers.
- (b) **Arduino Integrated Development Environment (IDE):** Is an open-source software that makes it simple to create and upload codes to the microcontroller board. This program is compatible with NodeMCU and Arduino boards.

2.3 The Design Procedure

A schematic diagram of the whole SH automation system is shown in Fig. 3. When the system is on, the Wi-Fi module will be active. Connection to the system on the host computer or smartphone is established through the Wi-Fi module. The Node-MCU generates an IP address which when used as a web address displays the system's dashboard. The user can simply select which appliance to control and also monitor real-time data on temperature, humidity and air quality. This process is depicted on the flow chart shown in Fig. 4.

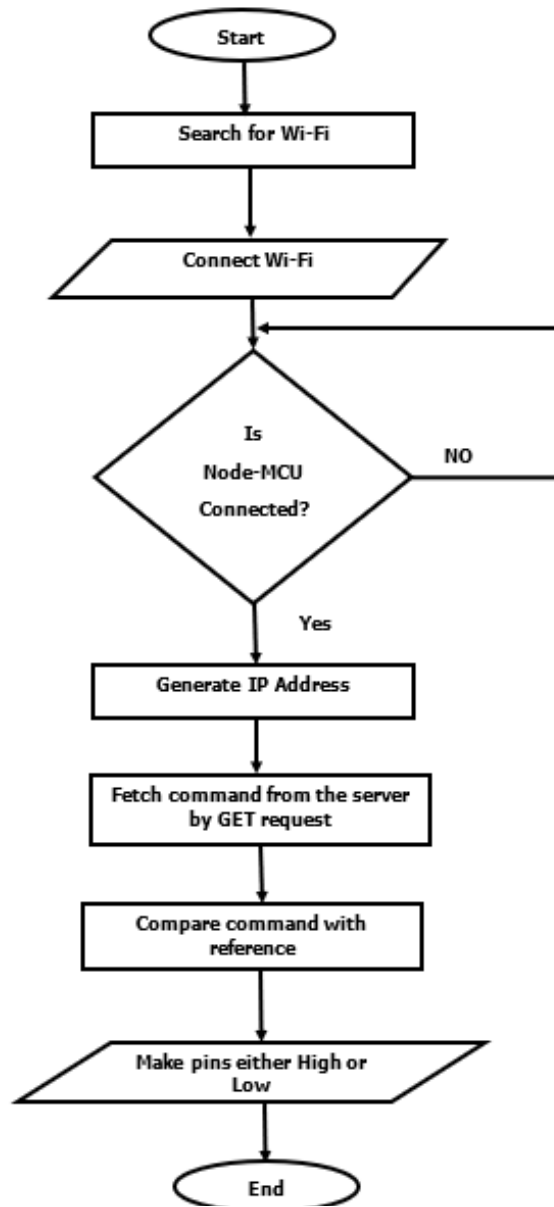

Fig. 4 Flowchart of the system

3. RESULTS AND DISCUSSION

The Wi-Fi based smart home monitoring and control system using NodeMCU was designed and implemented in this paper. Fig. 5 shows the prototype of the complete work. Different experimental tests such as remote switching of appliances and real-time monitoring of temperature, humidity and smoke were conducted to assess the performance of the prototype system.

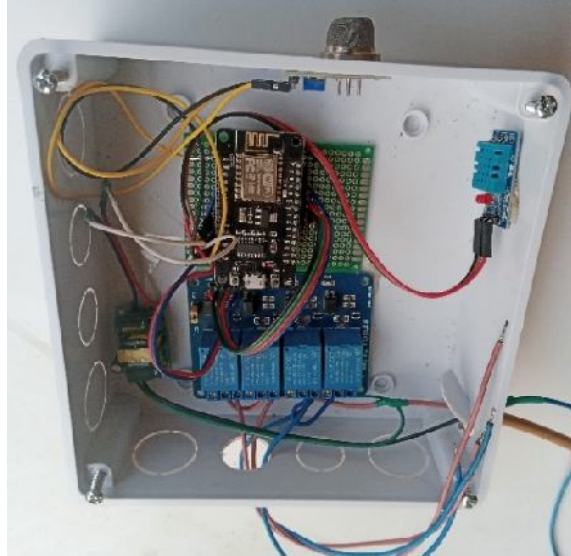
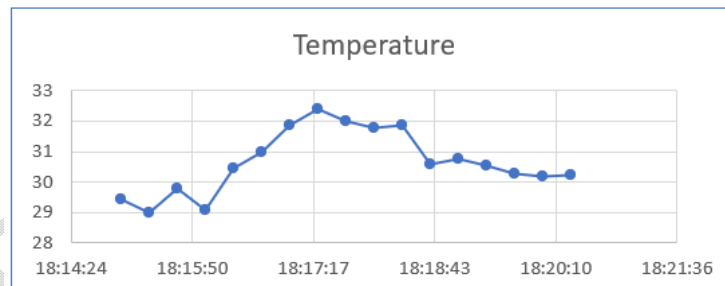

Fig. 5. Complete prototype of the Smart Home automation system

3.1 Temperature and Humidity Test

This test was conducted by introducing a hot iron close to the temperature sensor DHT11. Temperature and humidity data are continuously updated and saved on the web dashboard display which may be viewed through a mobile phone or computer. Fig. 6(a) and 6(b) show the obtained results on the dashboard.



(a)

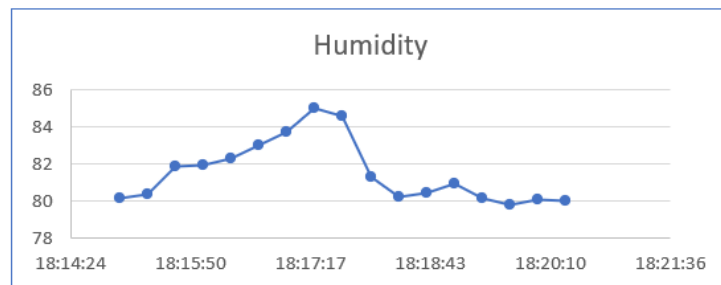

(b)

Fig. 6. Real-time measurement of temperature and humidity from the dashboard (a) Temperature (b) Humidity

It can be observed from Fig. 6(a) that the temperature rises as a result of the heat from the iron. After the heat was withdrawn, the temperature drops to about 30 degrees. Similar readings were observed for the humidity as shown in Fig 6(b).

3.2 Smoke Detection Test

The smoke detection system alerts the user in the event of a fire outbreak. The sensor reads and displays the level of concentration of smoke in the air and a buzzer sounds an alarm. Fig. 7 shows the real-time data from the MQ2 sensor when a smoke is introduced by burning a piece of paper. It can be observed that the smoke concentration in the air measured in parts per million (ppm) rises sharply when a smoke was introduced.

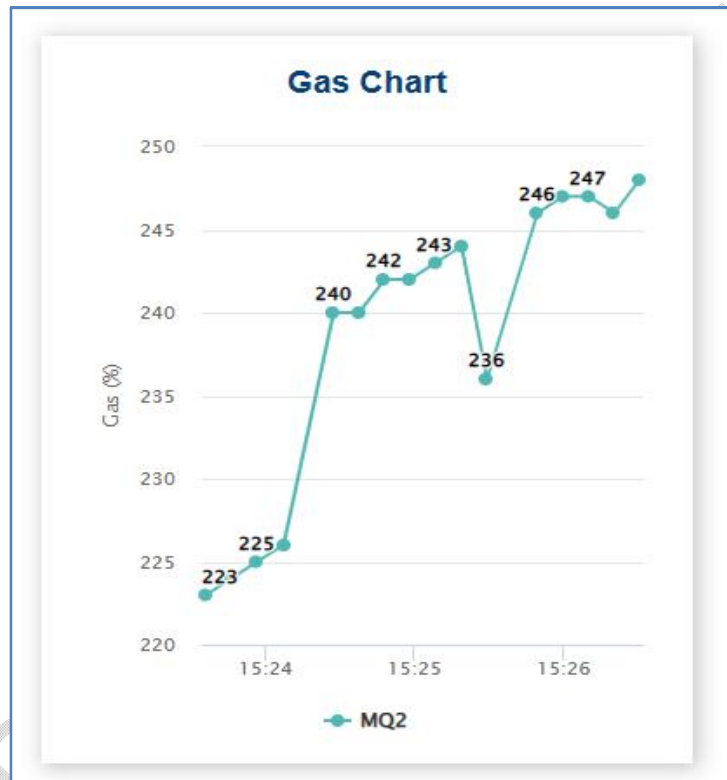

Fig. 7. Real-time measurement of smoke concentration in the air from the dashboard display

3.3 Control of Appliances

For the purpose of demonstration, two light points and two sockets were controlled remotely. Fig. 8 shows the test on the prototype system. The system was able to control the sockets via the webpage dashboard at a distance within the Wi-Fi coverage. Based on our test at various distances, a maximum coverage distance of 67.054 meters was achieved. A smart phone was used for hosting the dashboard, thus making the system portable, convenient and user friendly.

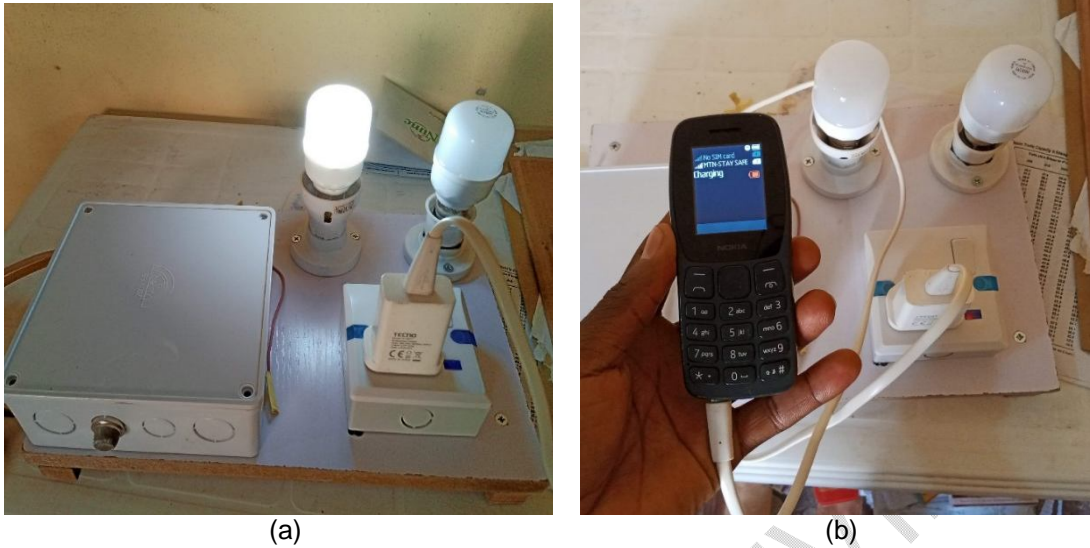

Fig. 8. Real-time remote control of appliances (a) Lighting points control (b) Socket control

4. CONCLUSION

This paper presented the design and implementation of a Smart Home automation system using NodeMCU, DHT11 sensor module, MQ-2 gas sensor module, relay module and web-based interface for the purpose of controlling home appliances and real-time monitoring of the home environment. Although the prototype system was able to control a handful of home appliances, none the less, the system can be upscaled easily to allow for complete control of all home appliances. The system provides users a convenient and inexpensive solution for real-time home control and monitoring using their smartphones.

REFERENCES

1. Gunge V. S. and Yalagi P. S. Smart home automation: a literature review. *International Journal of Computer Applications*, vol. 975, pp. 88-93, 2016.
2. Ishaka U. Design and construction of GSM Based home automation with AT Command. M. ENG. Thesis Report, MAU, Yola, Nigeria, 2012.
3. Obe O.O., Oluwafemi S. and Boyinbode O.K. Development of wireless home automation system for disabled people. *international journal of science and engineering research*, vol. 9, no. 1, 2018.
4. Joshi U., Dills A., Biazio E., Cook C., Chen Z., and Wang G. Designing and Implementing an Affordable and Accessible Smart Home Based on Internet of Things. *Investigations: The Journal of Student Research@ IPFW*, 2018.
5. Soumya S., Chavali M., Gupta S. and Rao, N. Internet of Things based home automation system. *IEEE International Conference on Recent Trends in Electronics, Information & Communication Technology (RTEICT)*, IEEE, pp. 848-850, 2016.
6. Bhatnagar H. V., Kumar P., Rawat S. and Choudhury T. Implementation model of Wi-Fi

- based smart home system. In *2018 International Conference on Advances in Computing and Communication Engineering (ICACCE)*, pp. 23-28. IEEE, 2018.
7. Jabbar W. A., Kian T. K., Ramli R. M., Zubir S. N., Zamrizaman N. S., Balfaqih M. and Alharbi S. Design and fabrication of smart home with Internet of Things enabled automation system. *IEEE access*, 7, 144059-144074, 2019.
 8. Aziz D. A. Webserver based smart monitoring system using ESP8266 node MCU module. *International Journal of Scientific & Engineering Research*, vol. 9 , no. 6, pp. 801-808, 2018.
 9. Anandhavalli D., Mubina N. S. and Bharathi P. Smart Home Automation Control Using Bluetooth And GSM. *International Journal of Informative and Futuristic Research*, vol. 2, no. 8, 2015.
 10. Shouran Z., Ashari A. and Priyambodo T. K. Internet of Things (IoT) of Smart Home: Privacy and Security. *International Journal of Computer Applications*, vol. 975, pp. 88-92.
 - [11] Edmonds M. How Smart Homes Work - Setting up a Smart Home. 2011. Available at: <http://home.howstuffworks.com/smart-home.htm>, accessed: March 25, 2023.
 11. Davidovic B. and Labus A. A smart home system based on sensor technology. *Facta Universitatis, Series: Electronics and Energetics*, vol. 29, no. 3, pp. 451-460, 2015.
 12. David N., Chima A., Ugochukwu A. and Obinna E. Design of a home automation system using arduino. *International Journal of Scientific & Engineering Research*, vol. 6, no. 6, pp. 795-801, 2015.
 13. Jabbar W. A., Alsibai M. H., Amran N. S. S. and Mahayadin S. K. Design and Implementation of IoT-Based Automation System for Smart Home. *International Symposium on Networks, Computers and Communications (ISNCC)*, no. IEEE, pp. 1-6, 2018.
 14. Imran S. S., Vignesh J., Singh V. K. and ArunPrasath D. T. Smart Home automation based on IoT using arduino mega. *International Conference on Current Research in Engineering Science and Technology (ICCREST-2016)*, no. E-ISSN, pp. 2348-8379, 2016.
 15. Ganesh E. Implementation of IOT Architecture for SMART HOME using GSM Technology. *International Journal of Computer Techniques*, pp. 2394-2231, 2017.
 16. Bhat O., Bhat S. and Gokhale P. Implementation of IoT in smart homes. *Int. J. Adv. Res. Comput. Commun. Eng*, vol. 6(12), pp. 149-154, 2017.
 17. Kodali R. K. and Soratkal S. MQTT based home automation system using ESP8266. in *IEEE Region 10 Humanitarian Technology Conference (R10-HTC)*, 2016.
 18. Ozeer U., Letondeur L., Ottogalli F.G., Salaün G. and Vincen J.M. Designing and Implementing Resilient IoT Applications in the Fog: A Smart Home Use Case. in *22nd Conference on Innovation in Clouds, Internet and Networks*, 2019.
 19. Letondeur L., Ottogalli F.G. and Coupaye T. A demo of application lifecycle management for IoT collaborative neighborhood in the Fog: Practical experiments and lessons learned around docker. in *2017 IEEE Fog World Congress (FWC)*, no. IEEE, pp. 1-6, 2017.
 20. Ozeer U., Etchevers X., Letondeur L., Ottogalli F.G., Salaün G. and Vincent J.M. Resilience of stateful IoT applications in a dynamic fog environment. in *Proceedings of the 15th EAI International Conference on Mobile and Ubiquitous Systems: Computing,*

Networking and Services 2018, pp. 332-341, ACM, 2018.

21. Konidala D. M., Kim D.Y., Yeun C.Y. and Lee B.C. Security framework for RFID-based applications in smart home environment. *Journal of Information Processing Systems*, vol. 7, no. 1, pp. 111-120, 2011.
22. He J., Xiao Q., He P. and Pathan M. An Adaptive Privacy Protection Method for Smart Home Environments Using Supervised Learning. *Future Internet*, vol. 9, no. 1, p. 7, 2017.
23. Ali B. and Awad A. Cyber and physical security vulnerability assessment for IoT-based smart homes. *Sensors*, vol. 18, no. 3, p. 817, 2018.
24. Gupta P. and Chhabra J. IoT based Smart Home design using power and security management. in *2016 International Conference on Innovation and Challenges in Cyber Security (ICICCS-INBUSH)* pp. 6-10, IEEE, 2016.
25. Malche T. and Maheshwary P. Internet of things (IoT) for building smart home system. in *2017 International Conference on I-SMAC (IoT in Social, Mobile, Analytics and Cloud)(I-SMAC)*, pp. 65-70, IEEE, 2017.
26. Badabaji S. and Nagaraju V. S. An IoT Based Smart Home Service System. *International Journal of Pure and Applied Mathematics*, vol. 199, no. 16, pp. 4659-4667, 2018.
27. Kaur S., Singh R., Khairwal N. and Jain P. Home Automation and Security System. *Advanced Computational Intelligence: An International Journal (ACIJ)*, vol. 3, no. 3, 2016.
28. Wenbo Y., Quanyu W. and Zhenwei G. Smart home implementation based on Internet and Wi-Fi technology," in *In 2015 34th Chinese Control Conference (CCC)* (pp. 9072-9077). IEEE, 2015.
29. Rye D. My Life at X10, AV and Automation Industry eMagazine. AV and Automation Industry eMagazine. Archived from the original on September 30, 2014. Retrieved March 8 2023.
30. Anonymous. 1.5 Million Home Automation Systems Installed in the US This Year, Accessed: 22nd January 2023. Available: <http://abiresearch.com>.
31. Anonymous. Smart Home - Statista Market Forecast, United States : Statista Retrieved 2019-11-07, 2019. Available: <https://www.statista.com>.
32. Caccavale M. The Impact of the Digital Revolution on The Smart Home Industry, Forbes. Retrieved March, 2023.
Available: <https://www.forbes.com/sites/forbesagencycouncil/2018/09/24/the-impact-of-the-digital-revolution-on-the-smart-home-industry/?sh=5a691c5f3c76>
33. Mandula K., Parupalli R., Murty C. A. S., Magesh E. and Lunagariya R. Mobile based home automation using Internet of Things(IoT). in *2015 International Conference on Control, Instrumentation, Communication and Computational Technologies (ICCICCT): 340-343*, 2015.
34. Saha S., Zunead M.D., Eidmum A., Moniruzzaman M., Hemal M., Khan A.H. and Muiz B. IOT Based Smart Home Automation and Monitoring System. *Khulna University Studies Special Issue ICSTEM4IR: 133-143*, 2022.