

On the Negative Wave Velocity and Advanced Waves in Electromagnetism

Abstract: Newton mechanics is great, Newton's contribution is indelible. But from Newton's classical mechanics, the definition of velocity ($v = dr/dt$) must mean that this physical parameter is a vector, so "negative velocity" only means the opposite direction of motion, no other meaning. It is difficult to understand negative velocity within the framework of classical mechanics. However, wave is a special form of material motion, wave mechanics has a unique method and meaning, and its concept and connotation are significantly different from classical mechanics. For example, wave velocity (whether phase velocity or group velocity) is a scalar quantity. "Negative wave velocity" does not mean that the direction of motion is reversed, but a special phenomenon that does not accord with causality from the surface view. In any case, research in recent decades has shown that negative wave velocity is not only theoretically possible, it has also been repeatedly shown to exist experimentally. Moreover, negative wave velocity is a special form of superluminal speed; The wave with negative velocity is the advanced wave. It corresponds to the leading solution of the basic equation of electromagnetic field and electromagnetic wave. The past practice (discarding the advanced solution) is wrong! As for causality, scientists have provided a new definition and interpretation. In short, both wave mechanics and quantum optics take a different approach from classical mechanics.

This paper points out that it is unusual for the 2022 Nobel Prize in Physics to be awarded to Alain Aspect and two others, since Aspect's experiments on the Bell inequality were completed in 1982, which still stands today as a crucial experiment that proved Einstein's EPR paper wrong and quantum mechanics (QM) correct. Aspect's award in 2022 showed that mainstream physical community had been forced to accept that quantum entanglement existed and that the "light-speed limit" theory of SR was a mistake.

This paper discusses the proposition "negative characteristic motion of electromagnetic wave" put forward by the author in 2013, pointing out that it is an inherent physical phenomenon reflecting symmetry in nature. In this paper, the faster-than-light motion of waves found in the near-field of antennas is discussed. In addition, the realizability of "faster-than-light space voyage" and "time travel" is also discussed.

Key words: Negative wave velocity; Negative group velocity; Advanced solution; Advanced wave; Superluminal; Near region field; Causality

1 Introduction

Waves are common phenomena in nature, such as wheat waves in the field, waves in the ocean. Of course, electromagnetic wave is a very important kind of wave. Matter must have mass, so a

wave is not matter itself, but an external manifestation of its motion. Newton's classical mechanics, which studied the motion of particles, extended to objects on the ground and celestial bodies in the universe. The uses of Newton's mechanics were ubiquitous; But it does not generalize the motion of waves. In fact, Newton didn't study waves. A wave is an external form of motion of matter with no fixed shape and definite mass, which cannot be accurately described by Newton mechanics. For example, its trajectory cannot be found in Euclid space, nor can it be accelerated by force. In modern theories of electromagnetic field and wave, operator theory and wave function space are used to describe its motion state, which is very different from the treatment of macroscopic matter.

With regard to the negative wave velocity, it must be pointed out by M.Born and E.Wolf^[1] in their famous book 《Principles of Optics》 that the velocity of waves (phase velocity, group velocity) is a scalar rather than a vector. Unfortunately, some physicists are not clear about this and insist that "negative velocity is motion in the opposite direction".

"Negative velocity" means the opposite direction of motion in Newton mechanics, but not in wave mechanics. Although Einstein^[2] (in 1907), Sommerfeld^[3] (in 1914), and Brillouin^[4] (in 1960) all discussed negative velocity problems, their theories were either flawed or incomplete; They need to be restated today. In addition, although J.Wheeler and R.Feynman^[5] pointed out as early as 1945 that the advanced solutions of Maxwell-Helmholtz wave equation should not be arbitrarily discarded, they did not dare to say that there would be a single advanced wave. Today, we know that there are waves with negative velocity. For example, in 2009, N.Budko^[6] experimentally discovered the negative velocity in the near field of an antenna. The phenomenon occurs in free space and does not depend on materials such as anomalously dispersive media.

Since wave motion is a unique manifestation of matter, a new understanding of wave velocity is needed now. The study of wave velocity is a key point and breakthrough in wave science. In this paper, believe that the advanced wave exists and the negative wave velocity is a special form of superluminal velocity. For the advanced wave, this paper defines it as "wave with negative velocity".

2 Plane spectrum method in electromagnetic field analysis

We will now outline the relationship between the antenna problem solving method and the advanced wave. Several decades ago, the calculation of antenna once attracted the attention of the Chinese scientific community. In the fall of 1969, relations between China and the Soviet Union were strong and war seemed imminent. In October of that year, the Chinese government held a conference on the security of broadcasting and communication systems to examine war readiness. One of the decisions made at the meeting was to ask scientists to solve the problem of reducing the

size of antennas, since huge antennas are difficult to conceal. The Chinese Academy of Sciences has set up the Antenna Computing Group to conduct numerical research on dipole antennas. The first thought was the solution of Maxwell wave equation. The calculation includes: (1)the near region—the region near the antenna that is far smaller than the wavelength; (2)the far region—several wavelengths and further away from the dipole. The serious problem is that the wave equation has two sets of convergent and divergent solutions. How to prompt the computer to keep only the outwards divergent solutions? In analytical processing this is known as the Sommerfeld boundary condition. What to do in numerical computation? Later, it was suggested to solve the initial value problem of Maxwell equations of order 1 directly until the steady-state solution was obtained. This simply circumvents the other boundary condition by adding the zero field condition at infinity. The traditional antenna calculation method is to first give the current distribution on the antenna, and then use the retarded potential integral expression to calculate the radiation field and antenna parameters. Strict numerical calculation (using the high speed and large capacity computer at that time) has been insufficient, especially to consider the far field from the origin of the antenna (theoretically infinite), it is difficult. A fundamental question is, is it better to start from the wave equation or from the basic electromagnetic field equation?

In free space, if there is no charge source (body charge density $\rho = 0$) and no current source (conductivity $\sigma = 0$ or current density vector $\mathbf{J} = 0$), the electromagnetic wave equation can be written as:

$$\nabla^2 \mathbf{E} - \epsilon\mu \frac{\partial^2 \mathbf{E}}{\partial t^2} = 0 \quad (1)$$

$$\nabla^2 \mathbf{H} - \epsilon\mu \frac{\partial^2 \mathbf{H}}{\partial t^2} = 0 \quad (2)$$

Where \mathbf{E} 、 \mathbf{H} are electric field intensity vector and magnetic field intensity vector; In the monochromatic simple harmonic condition, take the expression of wave $e^{j\omega t}$, then $\partial^2/\partial t^2 \rightarrow -\omega^2$, and get the vector Helmholtz equation:

$$\nabla^2 + k^2 \mathbf{E} = 0 \quad (3)$$

$$\nabla^2 + k^2 \mathbf{H} = 0 \quad (4)$$

and we have

$$k^2 = \omega^2 \epsilon\mu \quad (5)$$

For the sake of a concrete discussion, we may take an electric dipole as an antenna (fed centrally) and consider the related problems of far and near field. Figure 1 shows the electric dipole antenna and the field strength measurement plane.

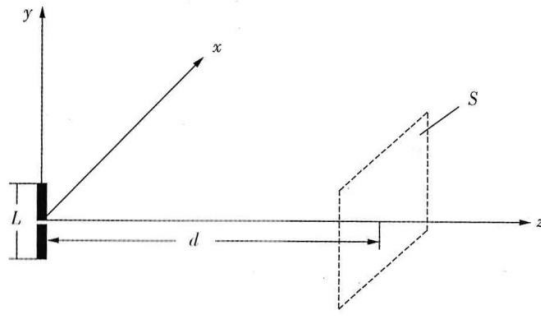

Fig.1 The dipole antenna and the near-field measurement plane

We now solve the electric field intensity; There is a solution at $r \geq 0$:

$$\mathbf{E}(x, y, z) = \frac{1}{2\pi} \int_{-\infty}^{\infty} \int_{-\infty}^{\infty} \mathbf{F}(k_x, k_y) e^{-jk \cdot \mathbf{r}} dk_x dk_y \quad (6)$$

Where \mathbf{k} is the wave vector and \mathbf{r} is the position vector. Similarly, magnetic field intensity can be derived:

$$\mathbf{H}(x, y, z) = \frac{1}{2\pi} \int_{-\infty}^{\infty} \int_{-\infty}^{\infty} \mathbf{k} \times \mathbf{F}(k_x, k_y) e^{-jk \cdot \mathbf{r}} dk_x dk_y \quad (7)$$

Where, k_x and k_y , is the component of the wave vector, satisfying the following relation:

$$\mathbf{k} = k_x \mathbf{i}_x + k_y \mathbf{i}_y + k_z \mathbf{i}_z, \quad k^2 = k_x^2 + k_y^2 + k_z^2$$

Therefore may be sought k_z , If $k_x^2 + k_y^2 \leq k^2$, there is

$$k_z = \sqrt{k^2 - k_x^2 - k_y^2} \quad (8)$$

If $k_x^2 + k_y^2 \geq k^2$, there is

$$k_z = -j\sqrt{k_x^2 + k_y^2 - k^2} \quad (9)$$

The imaginary number will correspond to an evanescent plane wave spectrum(PWS), k_z which is characterized by sharp decay from the source location with the increase of r . And this PWS can be determined by the boundary conditions of the $z=0$ plane.

In the above case \mathbf{F} is a vector function, which we will not discuss. But here we must consider the near field measurement, near field and far field relationship, evanescent field effect and so on. The outstanding point is how to calculate the evanescent state effect theoretically. The near field measurement technique was developed in the 1990s. This planar scanning near field measurement technique provides an economical and accurate way to determine the antenna pattern and its parameters. Its theoretical basis is the plane spectrum description of the field. There is a simple relationship between the antenna far field pattern and PWS. In most applications, the far field pattern can be obtained from the near field

measurement data after Fourier transformation.

Planar scanning is now available in the plane shown in Fig. 1, where d is in the near area. In that plane there is

$$\mathbf{E}_y(x, y, d) = \frac{1}{2\pi} \int \int_{-\infty}^{\infty} \mathbf{F}'_y(k_x, k_y) e^{-j(k_x x + k_y y)} dk_x dk_y \quad (10)$$

In formula

$$\mathbf{F}'(k_x, k_y) = \mathbf{F}_y(k_x, k_y) e^{-jk_z d} \quad (11)$$

It can be seen that $\mathbf{E}_y(x, y, d)$ and $\mathbf{F}'_y(k_x, k_y)$ is a Fourier transform pair; When $z=0$, we have

$$\mathbf{E}_y(x, y, 0) = \frac{1}{2\pi} \int \int_{-\infty}^{\infty} \mathbf{F}_y(k_x, k_y) e^{-j(k_x x + k_y y)} dk_x dk_y \quad (12)$$

Thus $\mathbf{E}_y(x, y, 0)$ and $\mathbf{F}_y(k_x, k_y)$ is another Fourier transform pair.

The above provides the theoretical basis; Due to the use of computer simulation, the aperture distribution of a dipole antenna can be calculated using the PWS method. The measurement plane is chosen to be close to the antenna, so the evanescent wave is included in the near-field measurement. Although the near-field behavior of the evanescent state has no effect on the far-field pattern, it is important for accurate modeling in the near field. The above principle has been demonstrated experimentally.

Based on the electromagnetic wave equation [Equations (1) and (2) in this paper], the boundary value problem of the second order elliptic partial differential equation is obtained by adding the boundary conditions. Due to some mathematical and physical reasons, it is difficult to calculate in this way. In 1977, a paper jointly published by the Institute of Physics and the Institute of Computing Technology of the Chinese Academy of Sciences analyzed the causes of the difficulties and pointed out that divergent waves tending to infinity had been selected in the analytical processing, excluding convergent waves. ... Finally, the calculation method chosen is directly discretized from Maxwell equations (first order hyperbolic equations), so that the initial value problem becomes an effective algorithm.

This paper considers that the above-mentioned early work of Chinese scientific community is beneficial. However, at that time; scientists did not realize that convergent wave solutions have special significance in the nearby region, and they could not be arbitrarily "excluded". This is what the author called the advanced wave, it is a solution to the Maxwell wave equation, is the existence of negative velocity physical performance! In the author's opinion, having two sets of solutions to the wave equation is not a "serious problem", but one of the features of nature. Nature may seem stranger than one can imagine, but we must take her for what she is.

3 Potential function analysis of electromagnetic fields and the solution of the d'Alembert equations

The static field analysis can be simplified by introducing scalar electric potential function, scalar or vector magnetic potential function in static field analysis. This method is even more important for alternating electromagnetic fields. In vector algebra, For vector \mathbf{A} , $\nabla \cdot \nabla \times \mathbf{A} = 0$, and Maxwell's equations have an equation $\nabla \cdot \mathbf{B} = 0$. Therefore, vector potential can be defined according to

$$\mathbf{B} = \nabla \times \mathbf{A} \quad (13)$$

Given that Maxwell's equations contain a formula: $\nabla \times \mathbf{E} = -\partial \mathbf{B} / \partial t$, so it can be obtained

$$\nabla \times \left(\mathbf{E} + \frac{\partial \mathbf{A}}{\partial t} \right) = 0$$

But in vector algebra, there is $\nabla \times \nabla \Phi = 0$ for any scalar Φ , so it is desirable, so we obtain:

$$\mathbf{E} + \frac{\partial \mathbf{A}}{\partial t} = -\nabla \Phi$$

so

$$\mathbf{E} = -\nabla \Phi - \frac{\partial \mathbf{A}}{\partial t} \quad (14)$$

Therefore, it can be determined \mathbf{E} by vector potential \mathbf{A} and scalar potential Φ ; Be known by $\mathbf{B} = \nabla \times \mathbf{A}$, \mathbf{B} may be determined. This is the basic concept of introducing the potential vector function to determine the electromagnetic field.

But in order to uniquely determine \mathbf{A} , Φ it is also necessary to know the value of $\nabla \cdot \mathbf{A}$. This is arbitrary, as given by Lorentz

$$\nabla \cdot \mathbf{A} = -\frac{1}{v^2} \frac{\partial \Phi}{\partial t}$$

Where v is the wave speed ($v = 1/\sqrt{\epsilon\mu}$), so the above formula is also written

$$\nabla \cdot \mathbf{A} = -\epsilon\mu \frac{\partial \Phi}{\partial t} \quad (15)$$

This is called the Lorentz condition. By substituting the formula for and into Maxwell's equations and citing Lorentz's condition, the following partial differential equations can be proved $\mathbf{B E}$:

$$\nabla^2 \mathbf{A} - \epsilon\mu \frac{\partial^2 \mathbf{A}}{\partial t^2} = -\mu \mathbf{J} \quad (16)$$

$$\nabla^2 \Phi - \epsilon\mu \frac{\partial^2 \Phi}{\partial t^2} = -\frac{\rho}{\epsilon} \quad (17)$$

The above two formulas indicate that, the source of \mathbf{A} is the current density vector; \mathbf{J} . The source of Φ is the bulk charge density ρ . The above equations are collectively referred To as d'Alembert equation. To facilitate the analysis of the problem, only the scalar equation of the function Φ can be considered. Assuming that the charge source is a point charge $q(t)$, it can be

shown that the solution Φ can be expressed in the following form:

$$\Phi = \frac{1}{4\pi\epsilon_0} \left[q\left(t - \frac{r}{v}\right) + q\left(t + \frac{r}{v}\right) \right] \quad (18)$$

Here v it can be the speed of light c or it can be a different value. The first term on the right of the equals sign means that the situation at the time t and space point $P(x, y, z)$ depends on the situation before t , i.e. $(t - r/v)$, so the space points lag behind the source. This is the phenomenon of retarded potential. The second term shows that the situation of the point P depends on the situation after t , i.e. $(t + r/v)$ so the space point is ahead of the source, which is an advanced potential phenomenon. The latter term should be removed from textbooks in the past because "it is impossible for waves to converge from the outside to the source", which does not explain the source of the wave. Moreover, it implies a negative velocity, i.e

$$t - \frac{r}{(-v)} = t + \frac{r}{v}$$

In the past, negative velocity used to mean "in the opposite direction," not that it was actually negative. If the velocity value itself is negative (independent of the direction of the vector), then it does not meet the requirements of causality, that is, cause precedes effect, not effect precedes cause. Today, these views are all wrong!

4 Negative velocity and the meaning of the concept of advanced waves

In recent years, the advanced waves has been proved by experiments, or we say the development of experiments has exceeded the theoretical expectation. In 2013, I published a paper "Negative characteristic motion of electromagnetic waves and negative electromagnetic parameter of medium"^[7], which mentioned that the concept of advance wave originated from the early papers of J.Wheeler and R.Feynman^[5]. In 1940, Feynman pointed out to Wheeler that a single electron in space does not emit radiation, but only when both the source and the receiver are present. Feynman analyzed the case of only two particles and asked Wheeler, "Does this force of one affecting the other and acting back on it explain radiation resistance?" Wheeler suggested introducing the concept of a advanced wave to the two-electron model—a previously neglected solution to the Maxwell equation. Wheeler and Feynman develop this concept into the relationship between the electrons and the multiple "absorbers"around them, that is, the radiation damping is viewed as the reaction of the charge of the absorbers on the source in the form of a advanced wave; Their theory now had symmetry, but only in terms of waves moving inwards and backward in time. There was just a new wrinkle – it went back to its source before it could be launched. But they avoided unpleasant contradictions by taking the customary hysteresis waves and cancelling them out with the advance waves in a suitable way; That is, all radiation is guaranteed to be absorbed at some point,

somewhere in the universe. This proved that they had not yet dared to use the concept of advanced waves alone.

The inward-moving wave described by Wheeler-Feynman (a wave moving backwards in time) is in fact the negative-velocity wave we are talking about now. There are two manifestations in wave science—negative phase velocity (NPV) and negative group velocity (NGV). In the past, when studying the cutoff waveguide theory, I found that the phase constant is negative ($\beta < 0$)^[8], which is actually a kind of advanced wave. Later, the British scholars put forward the experimental proof^[9,10]. $v_p < 0$ certainly means that the phase refractive index is negative ($n < 0$), but it does not mean that the advanced wave must be included in the framework of metamaterials (i.e., left-handed materials, LHM) to be understood. In the condition of ordinary materials, there is also the phenomenon of advanced wave, which can also be seen in the near-field physical state of general antennas. For example, N.Budko^[6] published a paper "Local negative velocity observation of electromagnetic field in free space" in 2009. The theory and experiment show that the near field and mid-field dynamics of vector electromagnetic field are much more complicated than the simple "outward propagation". There exists a region close to the source, where the wave front travels outward at the speed of light, while the core body of the waveform moves inward, that is, the wave travels backward in time, that is, the wave may travel back in time. Experimental observations of negative velocity were provided in this paper. It was believed that negative velocity in the near field area was found, and the first 5 near-field waveform at (3.5~8)mm showed that the internal peak was retrograde to time. Therefore, electromagnetic waves may travel faster than the speed of light in free space under near-field conditions even if there is no medium.

In 2013, I put forward the concept^[7] of "negative characteristic motion of electromagnetic waves" and distinguished it from simple "reverse motion". The paper argues that it should be regarded as a normal physical phenomenon inherent in nature.

Wheeler wanted to determine what would happen if retarded and advanced electromagnetic waves always occurred equally. In particular, it means that radio transmitters emit half the wave's power into the future and the other half into the past. All advanced electromagnetic waves can be considered to disappear from observation for the following reason: As retarded electromagnetic waves from a particular source of waves on Earth spread through space and encounter matter, they are absorbed. This absorption process involves the interference of electrical charges caused by the electromagnetic waves, with the result that distant charges produce secondary radiation. According to the hypothesis of this theory, this radiation is also half delayed and half advanced. The advanced component of this secondary radiation travels in the opposite direction of time, and some of it travels to the source of the emission on Earth. This secondary radiation wave is just a weak

reflection of the source, but there are countless such weak reflections from space that can have a huge additive effect. It can be shown that under certain conditions, these advanced secondary radiation can be used to strengthen the primary delayed wave to its maximum intensity. At the same time, the leading component of the wave source is eliminated due to interference cancelling. At the end of time, when all these electromagnetic and reflected waves are added together, the net effect appears to be pure retarded radiation.

P. Davies^[11] argues that Wheeler-Feynman's theory assumes that the universe is rich enough to absorb all the radiation going into space, so the universe is opaque to all the electromagnetic waves. That's a strict condition. Judging from the surface, the universe seems completely transparent to many different wavelengths of wave, otherwise we can't see distant galaxies. On the other hand, there is no time limit to the absorption process, because reflected waves ahead (in the opposite direction of time) can travel backward through spacetime, and it is just as easy for them to travel back from the distant future as it is from the near future. So the success of the theory depends on whether an outwardly propagating electromagnetic wave can eventually be absorbed somewhere in the universe.

Davies says, we don't know if this is really the case because we can't predict the future. However, we are able to extrapolate current trends in the universe, and the result seems to be no—that the universe is not completely opaque. This would seem to negate Wheeler-Feynman's idea, but there is a curious possibility. Suppose there is enough matter in the universe to absorb most radiation, but not all of it. According to Wheeler and Feynman, this would lead to incomplete cancellation of advanced electromagnetic waves. Could it be that there are some advanced electromagnetic waves that have "walked into the past"—or come from the future—but whose wave intensity is so low that we haven't detected them yet?

Now, I must say that there are points Wheeler-Feynman (and Davies) makes that we cannot agree with. For example, the advanced wave is always cancelled out by the retarded wave, so that there is no single advanced wave. Experiments in recent years (mostly since 1998) have made us more confident that the existence of advanced waves has been confirmed by numerous NGV experiments and antenna near-field experiments, and that they are not offset. And logically, why is it that the advanced wave is always cancelled out and the retarded wave is not? That doesn't make any sense. The three scientists said that because of the limitations of their time, we now have a unified understanding of advanced wave and negative velocity.

In order to improve life and explore the universe, human beings have made unremitting efforts to improve the motion speed of macroscopic matter; At the same time in the micro-field of exploration, research near the speed of light, the speed of light beyond the particle dynamics.

Scientific concepts are also being expanded, such as the in-depth exploration of negative velocity and advanced waves.

5 The success of many negative group velocity experiments is proof of the existence of advanced waves

The founders of the classical wave velocity theory were A.Semmerfeld and L.Brillouin in 1914^[13]. In 1960, Brillouin^[14] presented the curve of the relation between c/v_g and f calculated on the basis of this theory, which clearly showed the process of changing v_g from positive to negative. Brillouin said: "This curve presents a curious anomaly in the absorption band, c/v_g can become less than 1, and even less than zero. This means that the group velocity can be greater than the velocity of light, v_g can be infinite and even negative!"

The curious NGV physical phenomena of light pulse propagation was first proposed by C.Garrett^[12]. This is theoretical rather than experimental work. He proved that the concept of group velocity can be used even under strong anomalous dispersion (which v_g can be greater than the speed of light c or even negative) and explained the time advance phenomenon. In 1982, S.Chu's paper^[13] first proved the existence of NGV by experiment, and the experimental results perfectly gave three states ($v_g > 0$, $v_g = \infty$, $v_g < 0$), which were very similar to the calculation curve provided by Brillouin in 1960. He also pointed out that when the peak of the pulse emerges from the sample at an instant before the peak of the pulse enters the sample.

After many years of exploration and research, scientists from many countries have used various methods to do successful group velocity superluminal experiment and negative group velocity experiments, which can be summarized into the following categories:

① In the short wave and microwave bands, using the combination of transmission lines to create the abnormal dispersion state, so as to obtain the superluminal group velocity and even negative group velocity. For example, in 2002, Hache^[14] was cascaded with multiple coaxial segments and obtained $v_g = (2 \sim 3.5)c$. In a similar way, Munday^[15] obtained $v_g = 4c$ and $v_g = \cdot 1.2c$. In 2003, Huang^[16] obtained $v_g = 2.4c$; Zhou^[17] won $v_g = 2.2c$ and $v_g = \cdot 1.45c$; In addition, in 2012, Yao^[18] cascaded 3 rectangular waveguides, and mode effect and interference effect caused group velocities exceeding the speed of light, $v_g = 10c$.

It is worth mentioning that in 2014, I instructed doctoral student Jiang to carry out experiments in microwave^[19], using left-handed transmission line (LHTL) and negative refraction ($n < 0$) on the basis of anomalous dispersion, to obtain negative group velocity, $v_g = \cdot 1.85c$. We use the digital oscilloscope to compare the input waveform and the output waveform, intuitively see the output is ahead of the input.

The above experiments are carried out in the framework of classical physics, without the intervention of quantum theory and technology.

②The method and technique of quantum optics are adopted, but the state of anomalous dispersion is still used. Specifically, the use of electromagnetic induction absorption (EIA) media anomalous dispersion states; In 2000, Wang^[20] passed cesium atomic gas with laser pulse at optical frequency, and obtained negative group velocity $v_g = \cdot c / 310$; Stenner^[21] used laser pulse to pass through potassium atomic gas in 2003, and obtained negative group velocity $v_g = \cdot c / 19.6$. In 2006, Gehring^[22] used erbium-doped fiber amplifier at optical frequency, due to the anomalous dispersion of the gain system, laser pulses through the fiber to obtain negative group velocity $v_g = \cdot c / 4000$.

③Still using quantum optics, but technically more complicated. For example, anomalous dispersion states in electromagnetic induction absorption (EIA) media are used; In 2011, Zhang^[23] used the nonlinear process of excited optical Brillouin scattering in optical frequency to construct an optical fiber ring cavity, through which laser pulses can obtain superluminal group velocities and negative group velocities. It is also observed that the output signal is ahead of the input signal, and the negative group delay $\tau_g = -221.2\text{ns}$; In 2012, Glaser^[24] uses laser pulse through rubidium gas chamber at optical frequency, and uses 4 wave mixing technology to obtain negative group speed $v_g = \cdot c / 880$.

④Still use the method and technology of classical physics, but introduce some special electromagnetic state. For example, the use of electromagnetic devices in the evanescent state; Enders^[25] in 1992 discovered group velocities exceeding the speed of light, $v_g = 4.7 c$, when microwaves sent pulses through a cutoff waveguide in the evanescent state; Nimtz^[26] obtained $v_g = 4.34 c$ by the same method in 1997; In 1999, Wynne^[10] obtained group delay $\tau_g = \cdot 110\text{fs}$ by a similar method.

The above experiments cover the three frequency bands of short wave, microwave and visible light, including classical techniques and quantum techniques, simple methods and very complex ones. The achievements and significance of these works cannot be denied.

6 A new theory of near-field electromagnetic phenomena

As mentioned at the beginning of this article, the outside of a source of electromagnetic radiation, such as an antenna, is divided into near and far regions depending on distance. In fact, there is a transitional middle region between the two. Recent studies have shown that the dynamics of the near-zone field and the middle-zone field are much more complex than that of the far-zone field, and several special properties have been discovered successively, mainly in four aspects:

- static property, that is, similar to static field(such as electrostatic field);
- evanescent state, that is, properties similar to the evanescent field^[27], such as the characteristic of almost pure reactance, and the rapid decay in field strength with distance;
- superluminal property, where it may travel faster than the speed of light;
- negative velocity property, that is, the possibility of a negative wave velocity, as well as a reverse motion in time, is actually the appearance of a forward wave.

Why is the near field so different from the far field? Why does it have these strange properties? We can't fully explain it yet, but we'll have to learn more in the future.

In Newton mechanics, the law of gravitation is also called Inverse Square Law (ISL), which is written in the following form:

$$F = G \frac{m_1 m_2}{r^2} \quad (19)$$

Where G is the Newton gravitational constant:

$$G = 6.673 \times 10^{-11} \text{ m}^3/\text{kg} \cdot \text{s}^2$$

In the more than 300 years since ISL was proposed, no theory has come close to matching it in accuracy of prediction.

If we notice that the area of a sphere of radius r is calculated by the formula:

$$S = 4 \pi r^2 \quad (20)$$

It is easy to understand why the inverse square law appears in different physical phenomena. ISL was proposed by Newton in 1687; In 1785, 98 years after ISL appeared, the French physicist C.Coulomb announced that he had experimentally found that the repulsive force between two spheres with the same number of electrostatic charges is inversely proportional to the square of the distance between the centers of the spheres and proportional to the product of their respective charges, i.e

$$F = K \frac{q_1 q_2}{r^2} \quad (21)$$

This is Coulomb's law, and it's surprisingly similar to the law of gravitation, which has inspired further comparative studies. In fact, Coulomb's law is also ISL. Assuming that gravity travels faster than light, does the Coulomb field (electrostatic field) also travel faster than light? This is possible, and the international research has also been carried out in this way, and the relevant results will in turn promote the research on the gravitational propagation velocity.

In 2000 R.Tzontchev^[28], a Mexican physicist, carried out research using a van de Graaf electrostatic generator. The radius of the two metal spheres is 10cm, the distance between the centers is 3m, and the height is 1.7m above the ground. Sharp electrical pulses were used. It was measured that Coulomb's action propagated at $v = (3.03 \pm 0.07) \times 10^8 \text{ m/s}$, which was $v = 1.0107 c$. It is faster than the speed of light.

R.Smirnov-Rueda is a Spanish physicist who supervised papers in 2007; One paper was by A.Kholmetskii^[29] "Experiments on binding magnetic field delay conditions", in which two faster-than-light data($v = 2c$, $v = 10c$) are obtained by conducting experiments using a ring antenna. The explanation is "non-locality properties of bound fields in near zone". As we know, non-locality is one of the important properties of quantum mechanics(QM), and its meaning is almost equivalent to superluminality. Therefore, the point of view of this paper is significant: it is necessary to use quantum theory to study near-region field.

The other paper of A.Kholmetskii^[30] is "Measurement propagation velocity of bound electromagnetic field in the near region", which is more complete in theoretical analysis, calculation and experiment. Both the transmitting and receiving antennas are ring antennas, mounted on a wooden table larger than 3m in size. The experiment gives the relationship between v/c and r . In the far region ($r \geq 80\text{cm}$), $v = c$; In the near region, when $r = (50\sim 60)\text{cm}$, $v/c = 4.3$; When $r = 40\text{cm}$, $v = 8.2c$. The conclusion is that, when $r < \lambda / 2\pi$, the bound field travels at a faster-than-light speed, exhibiting apparent non-locality.

In 2011, the paper of Missevitch^[31] seems to be the third study on the near-area bound field of antenna under the guidance of Smirnov-Rueda, and the experimental techniques and methods have been improved. One measurement result given in this paper is $v = (1.6 \pm 0.05)c$; The authors consider the work in question to be "physics of EM wave propagation at a speed exceeding light."

In his 2014 paper, "Measurement of propagation velocities in Coulomb fields", R.Sangro^[32] began by discussing the problem of gravitational propagation velocities. This justifies our judgment that static or quasi-static fields in the universe have similar laws and can be usefully studied in comparison. The source is not merely an isolated charge, but a beam of electrons in uniform motion, that is, an electric charge moving at a constant velocity, whose electric field is still the Coulomb field. The experimental technique is complex and delicate. The results do not provide clear velocity data, but confirm the idea that the electron beam carries the Coulomb field.

The above literature covers the period from 2004 to 2014, and the obtained Coulomb field propagation velocity is in the range of $(1.01\sim 10)c$. These advances not only enrich our understanding of the near-field, but also make us firmly believe that "gravity propagates faster than the speed of light".

Now we discuss an important theoretical problem – the "evanescent state" property of near-field. The time phase factor of an electromagnetic wave is $e^{j\omega t - \gamma z}$, where z is the coordinate of the propagation direction (distance) and γ is the propagation constant ($\gamma = \alpha + j\beta$) α is attenuation constant, β is phase constant. For a metal-walled uniform column waveguide, the internal electromagnetic state is with a cutoff field, the cutoff frequency $\omega_c = 2\pi f_c$ (subscript c represents cutoff). It can be proved that the corresponding cutoff wavelength is

$$\lambda_c = \frac{2\pi}{h} \quad (22)$$

Where h is the eigen value, not the Planck constant. The above equation reflects the characteristics of the transmission system of non-zero eigen value.

Now define a parameter called propagation factor:

$$k_z = -j\gamma = \beta - j\alpha \quad (23)$$

Therefore, the transmission system can be divided into two areas, namely transmission area and cut-off area; Since the cutoff region is almost purely imaginary, the corresponding wave vector k_z is called imaginary wave vector and the corresponding wave is called imaginary waves. Now we can compare the two electromagnetic states in the waveguide:

① Transmission region (transmission state): $f > f_c$, α is small, β is large, So propagation constant $\gamma \cong j\beta$ (approximation); propagation factor $k_z \cong \beta$ (approximation);

② Cutoff region (evanescent state): $f < f_c$, α is large, β is small, propagation constant $\gamma \cong \alpha$ (approximation), propagation factor $k_z \cong -j\alpha$ (approximation).

In the evanescent state, the time phase difference between the electric field and the magnetic field vector is $\pi/2$ (TM mode magnetic field intensity \mathbf{H} lead, TE mode electric field intensity \mathbf{E} lead); Poynting vector instantaneous value $\mathbf{E} \times \mathbf{H}^*/2$ is a pure imaginary number, Poynting vector mean value $\text{Re}(\mathbf{E} \times \mathbf{H}^*)/2 \neq 0$, wave impedance is reactance, reflecting the storage of electric energy and magnetic energy. For the near field of electric small antenna, the phase difference of \mathbf{E} and \mathbf{H} is ($\cdot \pi/2$), \mathbf{H} is leading; The Poynting vector instantaneous value is pure imaginary, and the mean value is zero. It is also the property of energy storage field, which is manifested as electric reactance field. ...The above comparison shows that the property of the two is almost exactly the same!

Moreover, both of them decay rapidly with the increase of distance, but the decreasing law is different – the evanescent field follows the law $e^{-\alpha r}$, and the near field follows the law of inversely proportional relationship with r^3 or r^2 . We believe that under certain conditions the two can be very close; The evanescent state of field strength

$$E_e = E_0 e^{-\alpha r} \quad (24)$$

The field strength of the electric small antenna is

$$|E_s| = \frac{K}{r^3} \quad (25)$$

Now let $E_e = |E_s|$, i.e.

$$E_0 e^{-\alpha r} = \frac{K}{r^3}$$

Take the natural log of both sides of the equation and get

$$\ln E_0 \cdot \alpha r = \ln K \cdot \ln r^3$$

So we can get

$$a = \frac{1}{r} \ln \left(\frac{E_0 r^3}{K} \right) \quad (26)$$

As long as the above equation is satisfied, both fields fall exactly the same. This is unlikely in practice, but it is an interesting comparison between two fields.

In addition, both two fields have the character of quasi-static fields. In evanescent field theory, although it is a time-varying field, it can be regarded as a static field with a single electric field for the analysis of some structures (for example, TM mode in cut-off waveguide is analyzed and treated by equivalent capacitor, TE mode by equivalent inductor). In electrically-small antenna theory, a similar situation exists—the field near the antenna follows Poisson's equation and can be treated as an electrostatic field.

For these reasons, faster-than-light propagation has been found in both the evanescent field structure and the near-field structure of the antenna. In 2009, N.Budko^[6] conducted experiments in microwave and found the phenomenon of negative velocity propagation in near-field. Using vertical dipole antenna for transmitting antenna, microwave pulse center frequency 4GHz; Waveforms traveling in reverse time were observed. In addition

In 2011, O.Missevitch^[31] conducted experiments on meter waves and found that the fluctuation propagated at a faster-than-light speed in the near-field, $v = (1.6 \pm 0.05)c$. In 2013, Fan^[33] carried out experiments on short wave. He sent 20MHz sinusoidal wave signals to the ring antenna with a diameter of 25cm. He used two 3cm diameter coils to receive the signal at different distances. Prove that magnetic field line speeds in the near area can reach more than 10 times the speed of light ($v \geq 10c$).

Budko believed that there exists a region in which the body of the waveform is in reverse motion at any time—the extreme value of the waveform received by the recipient is progressively advanced as the distance from the source increases. Assuming that the source is a finite sinusoidal beam, the center frequency $f_0 = 4\text{GHz}$, then $r = 10 \sim 100\text{mm}$ for the near field and the midfield region, the simulation of the near field waveform shows that there is a negative velocity in the near field region (e.g. 10~13.6mm). In other words, the outer edges shift rightwards (normal phenomenon) and the inner part shift leftwards (negative velocity phenomenon). Note that this is independent of the environment, even in a vacuum.

The near-field electromagnetic phenomena revealed by Budko are amazing, for example he shows the details of several near-field waveforms as a function of time, which are obtained by progressively increasing the distance from the source (r). Although the edge of the wave packet moves to the right, the inside part moves to the left, traveling back in time. Experiments confirm the above simulation calculation, and the actual negative velocity region is about 8mm. Although the measured retrograde movement against time is small, this can be explained by factors such as the interaction between the source and the receiving antenna. Budko finally tries to explain the observed phenomenon in terms of classical or quantum theory, but it is clear that the paper is weak in this respect. One explanation is that both the near and intermediate field components contain an additional relative delay with respect to the far field. These relative delays gradually disappear with increasing distance from the field source. The overall effect of the radiation field therefore consists

of two parts: the usual outward motion at the speed of light, and the relative inward motion. This results in the speed of the selected waveform features in the near and middle fields significantly exceeding the speed of light.

The authors believe that the phenomenon of near-field superluminal can be explained by the evanescent state theory, and the phenomenon of negative near-field velocity can be explained by the advanced solution of Maxwell-d'Alembert equation. With the help of virtual photon theory, all of these are understandable physical facts. Budko, however, seems unfamiliar with these theories and feels a bit at sea.

Now we try to explain near-field faster-than-light phenomena with quantum theory. In 2007, Kholmetskii^[29] claimed that they "confirmed non-locality" in antenna near-field experiments, so a deeper understanding of this non-locality should be obtained. The author believes that among the three essential characteristics of quantum mechanics (QM), non-locality is the most important, and the core idea of which is superluminal. The affirmation of non-locality by near-field experiments indicates that there is a deep connection between classical electromagnetic theory and quantum theory, and natural phenomena can be understood and interpreted only when the two are used together.

In 1971, C.Carniglia^[34] published his paper "Quantization of electromagnetic evanescent waves", in which he "selected the virtual photon path of evanescent waves to express the field". In 1973, S.Ali^[35] published a paper "Evanescent wave in quantum electrodynamics", in which he said that "evanescent wave is actually virtual photons of the interaction between the carrying field and the source", and that evanescent wave will become a virtual particle swarm of quantitative theory. The evanescent field is the same as the virtual photons field, which is not a mode to mode identity. In 2006, A.Stahlhofen^[36] published a paper "Evanescent modes are virtual particle populations", in which he stated that many years of research based on QED agree that evanescent modes are consistent with virtual photons, and that their strange properties (such as non-locality and unobserved) violate relativistic causality. In 2000, Professor G.Nimtz wrote to me that "Evanescent modes can be correctly described and understood only when QM is introduced and considered; The evanescent mode appears as virtual photon, but it cannot be measured. would argue that evanescent modes are Galilei invariant".

Therefore, from the point of view of quantum field theory (QFT) and quantum electrodynamics (QED), Evanescent modes are the result of the overall contribution of virtual photon groups. Since the two components of the near field of an electromagnetic source (bound field and Evanescent field) are Evanescent state, it is useful to use the virtual photon theory as an explanation of the superluminal phenomenon in the ultra-near region. For example, Nimtz has pointed out that in Feynman-type space-time diagrams, the corresponding process of virtual photons is that space distance is changing while time is basically unchanged, which represents potentially extremely high velocities. This makes the author feel that when the classical electromagnetic theory

is used to study the cut-off waveguide, the phase constant near zero^[8] in the cut-off region is found, which indicates that the evanescent state propagates very fast.

In recent years, faster-than-light propagation and negative wave velocity propagation have been discovered very close to the source, both of which require more profound explanations. However, the comparative study on the connection between the above phenomena and the superlumen propagation of pure Coulomb field and the gravitational field filling the universe brings more enlightenments to people.

In this paper, a number of theoretical duals are given: bound field and evanescent field; Retarded solution and advanced solution; Positive wave velocity superluminal and negative wave velocity; Static electromagnetic and gravitational field propagation; Classical electromagnetic analysis and quantum theory analysis; Real photon and virtual photon. The duality of these dual properties is the manifestation of the nature of things.

7 Einstein's negative velocity idea and the proof of Brillouin's negative group velocity theory

We will now take the discussion further, first reviewing the early days of the negative velocity concept. At the beginning of the 20th century, A.Einstein^[37] thought about negative velocity during his work on special relativity (SR). Einstein believed that it was necessary to determine whether the velocity of physical action and the velocity of signal could exceed the speed of light, He was hesitant to do so. In 1907 Einstein^[2] published his article "On the principle of relativity and its conclusions", § 5 of which ("The addition theorem of velocities") deals with both signal velocity and negative velocity. The article said, Postulate

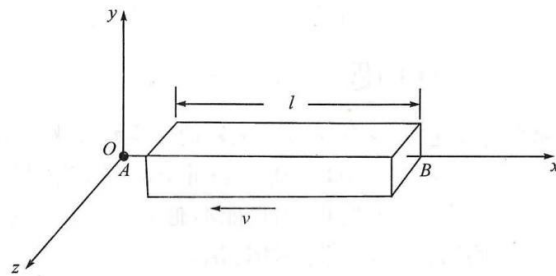

Fig.2 The graph Einstein used to discuss the speed of signals

Place a strip of objects (FIG.2) along the x axis of the frame of reference S relative to which some action can be transmitted by velocity u (judging from the strip of objects), and have stationary observers not only at the point, $x=0$ on the x axis (point A), but also at the point x (point B) S ; The person at the place A sends a signal to the person at the place B via the object, which moves in the direction of ($\cdot x$) with a velocity ($v < c$). Then, according to the SR velocity synthesis formula, the signal velocity is

$$v_s = \frac{u - v}{1 - \frac{uv}{c^2}} \quad (27)$$

The transfer time is

$$t_s = l \frac{1 - \frac{uv}{c^2}}{u - v} \quad (28)$$

Where, l is the object length. If $u > c$, select $v < c$, which can always make $t_s < 0$. This results in a negative transfer time, as well as a negative signal speed. According to Einstein, this transmission mechanism causes "the effect to arrive before the cause" and therefore "no such signal can be transmitted faster than the speed of light in a vacuum."

In his opinion, this statement is wrong. Since we have thoroughly analyzed and critically criticized the theory of SR^[38], we will not discuss SR itself nor comment on Einstein's formula of addition, but merely discuss it briefly. It is interesting that Einstein has made the basic judgment that "signal speed cannot exceed the speed of light", but he is not 100% sure. He said, "Although this outcome is logically acceptable, there is no contradiction in it; But it is so alien to the character of all our experience that the impossibility of the hypothesis $u > c$ seems sufficiently well established." Here, Einstein shows that something that violates causality does not violate logic, except that because it violates human experience, the speed of the signal cannot exceed the speed of light.

In 1914, A Sommerfeld^[31] and L.Brillouin^[39] developed a classical theory of wave speed, which, though not ideal, was far more valuable than Einstein's work. As is well known, there are two different concepts of wave velocity—phase velocity v_p and group velocity v_g , and the meaning of group velocity is generally considered to be greater than that of phase velocity. As for the evaluation of group velocity, there are two different tendencies—overestimation and underestimation. Examples of the former are British physicist Lord Rayleigh. In his book 《Theory of Sound》, in 1877, he not only defined group velocity, but also believed that group velocity is consistent with energy velocity and signal velocity. But we now know that this view is true only under certain conditions. There are others who believe that group speed is extremely important. The other view is that the estimation of group velocity is so low that it seems that its study (whether calculated or experimental) is not valuable and meaningful. The author disagrees with both of these tendencies. If you don't study group velocity; what should you use instead? In many cases, energy velocity and signal velocity are complex and practically difficult to master. In Sommerfeld-Brillouin(SB) theory, front velocity is considered as the propagation velocity of a sudden disturbance, and its definition is not clear. It can be said that when discussing the velocity of electromagnetic wave (or electromagnetic signal), the group velocity is still fundamental and important, and can be used as a valuable reference material in scientific research. The situation would be even better if complex (reshaping) measures were taken in the experiment to reduce

waveform distortion or to do no distortion at all.

In 1914, A.Sommerfeld^[3] discussed the wave velocity problem in detail. He assumed that a sine wave $f(0, 0)$ suddenly appeared on the surface of the medium $z=0$ at $t=0$, and the observer at z would not see the transient phenomenon occur until $t = z/c$. From this point on, no information is transmitted until the steady-state signal is established. Sommerfeld studied in the complex frequency domain ($p = \sigma + j\omega$), taking $f(0, 0)$ as the incident wave, he derived the wave of z described in the following integral equation:

$$f(z, t) = \frac{1}{2\pi j} \int_{\sigma-\infty}^{\sigma+\infty} \frac{\omega_0}{p^2 + \omega_0^2} e^{p(t-\frac{z}{c})} dp \quad (29)$$

In the formula, the real number σ should ensure that the integration path is in a certain region, and ω_0 is the steady-state carrier frequency. The above formula is also written:

$$f(z, t) = I_m \frac{1}{2\pi j} \int_{\sigma-\infty}^{\sigma+\infty} \frac{\omega_0}{p + j\omega_0} e^{p(t-\frac{z}{c})} dp \quad (30)$$

Actually no wave front arrives until $t = z/c$, and the wave front velocity is c ; When $t = z/c$, the steady-state and transient components cancel out and the wave is still zero. This indicates that the signal always builds up from zero. when $t > z/c$ there is

$$f(z, t) = e^{-\alpha z} \sin(\omega_0 t - \beta z) \quad (31)$$

α 、 β are the attenuation constant and phase constant of the medium respectively. The process before steady state is completely established is called precursors, they develop gradually and rapidly to complete a continuous transition.

In order to understand the whole process of signal establishment, the above integral equation must be solved. Also in 1914, L.Brillouin^[39] used saddle point integration to solve Sommerfeld's integral equation. After complex calculations and graphing analysis in the complex plane, he obtained a family of curves. Figure 3 is the relationship between sum and frequency given by Brillouin^[4] in 1960 according to the integral equation (note that the ordinate is the ratio of the speed of light to the speed of wave, i.e. c/v). showing that throughout the frequency domain, But Brillouin ruled out the possibility of negative phase velocity, which is not true. Brillouin's regular description of group velocity is more meaningful, as can be seen from Fiure3: there are cases of $v_g < c$ and cases of $v_g > c$. In addition, near the central frequency, three phenomena will appear, namely group velocity exceeding the speed of light($v_g > c$), group velocity infinite ($c/v_g = 0$), and negative group velocity ($v_g < 0$). It must be noted that the group velocity increases and increases until after infinity has passed, the negative group velocity is reached. These analytical results have been proved by a number of facts.

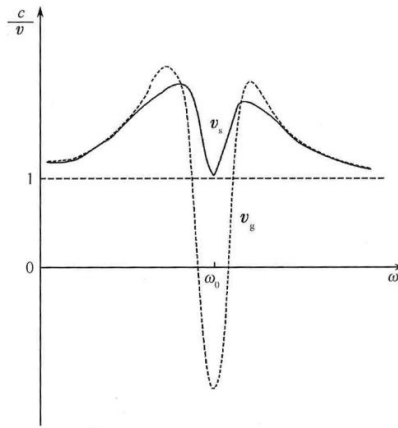

Fig.3 Phase velocity and group velocity in Brillouin theory

What do we think of the Sommerfeld-Brillouin wave velocity theory today? It would be wrong to say yes or no to it outright, The author points out that it has the following problems: (1)The theory excludes the possibility of negative phase velocity (and thus negative refractive index), which is inconsistent with the known theoretical and experimental results; (2)Although the theory points out the possibility of negative group velocity, it fails to elucidate its physical mechanism and significance; (3)The way the theory studies signal velocity, the ideal step function requires infinite bandwidth, can not be realized in practice, so people doubt whether there is a problem in the definition method and research method, that is, the theory does not construct a reasonable definition of signal velocity; (4)Because SB theory appeared many years before the invention of quantum mechanics, it is impossible for SB theory to estimate the faster-than-light phenomenon when the quantum barrier particles pass through the tunnel; (5)The theory lacks a strict definition of wave front velocity. ...However, SB theory still has some reference value for researchers today.

It must be noted that the ordinate of Figure 3 is c/v , i.e. c/v_p or c/v_g ; Thus, the point at which the curve representing the group velocity passes through $c/v_g=0$ indicates that the group velocity reaches infinity. Thus, the Brillouin diagram is characterized by its description of the group velocity increasing until it crosses infinity to reach negative group velocity. That is to say, NGV represents a negative velocity larger than the infinite velocity. This may seem unfathomable, but it's not particularly surprising. In a 2021 paper, I described a "negative-energy vacuum emptier than the free vacuum"^[40], based on the Casimir effect, a similar situation. People can wonder: how can anything be faster than an infinite velocity? It is also possible to wonder "how can a vacuum be emptier than a vacuum?" But natural science research has entered the stage where one has to admit something that is difficult to understand if it is supported by solid theoretical or experimental evidence.

This leads us to a conclusion. Any wave with a negative velocity must be a faster-than-light wave. What about the evidence? Back in 1982, S.Chu^[13] did an experiment that proved this idea. His experiment was the first of its kind, and at the same time very sophisticated. In 1979, three years

before Chu, R.Ulbrich^[41] conducted experiments with semiconductor (GaAs) samples at optical frequencies, and observed that light pulses propagate slowly, and that the group velocity v_g can be reduced from $c/3.6$ to $c/2000$. Although this was not an experiment in quantum physics; the experimental technique was distinctive. The sample thickness is $3.7\mu\text{m}$, the area is $200\mu\text{m} \times 500\mu\text{m}$, and the sample is placed at ultra-low temperature (1.3K). In his experimental system, the minimum group velocity can be obtained by adjusting the center carrier frequency ω_0 . The maximum delay $\tau_g = 35\text{ps}$ was observed in the experiment. This gives you a way to measure it.

S.Chu^[13], who published the paper "Linear pulse propagation in absorbing media", seems to have been the first person to experimentally prove the existence of NGVS, and it was the negative velocity that made the experimental breakthrough. Following Ulbrich's method, Chu used epitaxial GaP/N samples with thickness of $76\mu\text{m}$ or $9.5\mu\text{m}$; If the thickness is L , then there is

$$v_g = \frac{L}{\tau_g} \quad (32)$$

So measured τ_g and v_g can be calculated, and the sample from the optical path access and take out is the experimental step. Obviously, if the zero delay is measured ($\tau_g = 0$), it is measured v_g to the infinite. FIG.4 shows the experimental results when $L = 9.5\mu\text{m}$ is taken. It can be seen that all three aspects ($v_g > 0$, $v_g = \infty$, $v_g < 0$) are present, and the transition is smooth. Here we should point out that this experimental curve is very similar to the theoretical calculation curve of Brillouin (group velocity curve in Brillouin diagram) many years ago!

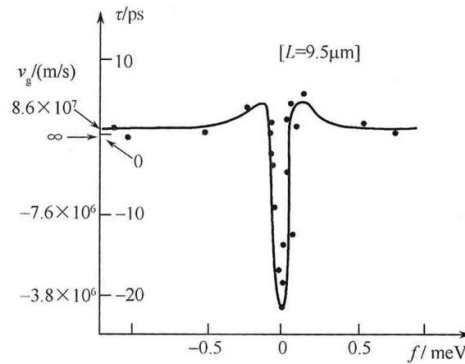

FIG.4 Earliest experimental results of NGV (Chu, 1982)

The negative pulse velocity obtained by Chu shows that, when the peak of the pulse emerges from the sample at an instant before the peak of the pulse. (when the peak of the pulse emerges from the sample at an instant before the peak of the pulse enters the sample). In 2000, Wang^[14] also discovered that this phenomenon, which some theoretical physicists thought impossible, was a bizarre theory. But in fact, it was discovered by Chu before Wang 18 years ago!

8 The advanced wave is a wave with a negative velocity

Although both Chu^[13] and Wang^[14] measured NGV, the former did so using classical physics methods and the latter using quantum optics. Interestingly, when Wang's paper was published in the prestigious journal 《Nature》, it raised some eyebrows among relativists because it described itself as a "faster-than-light experiment." For example, [42] was fiercely critical of Wang's paper and its implications. However, although the author of reference [42] is familiar with the theory of relativity, he does not know Born and Wolf that "wave velocity is a scalar rather than a vector", and does not know Sommerfeld-Brillouin theory of wave velocity, and thus makes a wrong judgment. [42] says that the result of Wang's experiment is $(v_g = \cdot c / 310)$, which after taking the absolute value gives $c / 310$, and is therefore sublight speed. This statement is completely incorrect; Wang's result was $(\cdot c / 310)$ not $c / 310$, which is fundamentally different.

Not only do they know this, but the authors [42], though admirers of Einstein, have no idea what his 1907 paper said. Recalling Einstein's^[2] 1907 discussion, it is characteristic that negative transmission time appears simultaneously with negative signal speed; And this discussion shows that negative velocity is one of the characteristics of superluminal speed, so Einstein denied the meaning of negative velocity in order to prove that superluminal speed does not exist. Thus, the key lies in experiments, and if experiments (not just the Wang's experiment^[34], but many more in recent years) prove the existence of negative velocity, then that indicates the existence of superluminal velocities. That is why Wang insists that his experiment is a faster-than-light experiment. So [42] the main argument doesn't work. Moreover, it is wrong to think of the "negative" of a negative velocity simply as "in the opposite direction", since wave velocity should be regarded more as a scalar than a vector.

Literature [42] also has merit; First, it points out that the study of faster-than-light problems is often linked to the concept of negative energy. "The light pulse moves from the exit to the entrance at $(\cdot c / 310)$, which is consistent with our calculation of the velocity of the negative energy density; The negative energy density is difficult to explain, and 'negative' may represent energy extraction from the cesium gas."

Secondly, [42] makes a theoretical concession on the relativistic proposition that "SR does not allow faster-than-light speed". The paper states: "SR does not rule out that light does not move faster than other matter. The key is to judge the order of causality in proper time, so that if the law of causality is satisfied in its inertial frame, it will be satisfied in all inertial frames; The modification of Einstein's interpretation of causality allows for the existence of such superluminal velocities."

However, this argument still absolutizes the law of causality as an "iron law" that cannot be broken. Since a wave with a negative velocity is a wave, it is also against the classical law of causality for such a wave. We emphasize once again that the existence of a single advance wave is possible, which has been confirmed by many NGV experiments and near-field experiments. The author believes that it is helpful to describe the phenomenon of negative wave velocity with space-time diagram. For example, the experiment of Wang^[14] can be described in Figure 5. Where L is the thickness of the air chamber. This figure can also be used to illustrate Chu's experiment,

then L is the sample thickness.

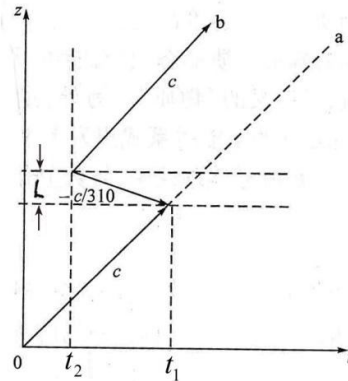

Fig. 5 The space-time diagram of the negative velocity experiment

The abscissa of Figure 5 is time (t), the ordinate is distance (z), and t is the departure time of the motion of the light pulse. At this interval of $0 \sim t_1$, the pulse travels in vacuum at the speed of light (c). When $t = t_1$, the light pulse enters the air chamber, the group velocity becomes negative ($v_g = \cdot c/310$). When $t = t_2$, the light pulse appears at the exit, but $t_2 < t_1$, i.e. $t_2 \cdot t_1 < 0$ (negative time). From the beginning, the light pulse continues to move forward at the speed of light, shown higher up in the diagram. ... This figure has some value, but it is more complicated in practical analysis and involves consideration of the width of the optical pulse, which is omitted here.

9 New understanding of causality

The English word "causality" is important, which is different from the English word "causal law". Relativists like to use the term causal law, implying that it is a law that cannot be violated at all. However, there is no such law in physics. Causality, like symmetry, is a conviction. Its meaning is: (1)Everything has a cause; (2)Every cause has an effect; (3)The cause must precede the effect. Taking advantage of the receptivity of everyday experience, some people introduce it into the study of natural science and place it in a sacred place and high place.

Associated with this is certainty, known in English as definity. It is also the belief that nature is intrinsically predictable and that all events are determined by a prior cause and follow certain rules. It is just a matter of finding that law and mastering the initial state so that the future can be deduced precisely from the present. In 1814 P. Laplace said: "The future of the world can be determined by its past; The state of the world at any given moment (expressed mathematically) can be predicted." This is a typical view of deterministic causality. By the 20th century, the poster child for this view as Einstein. On January 20, 1920, Einstein wrote to M.Born: "The question of causality troubles me; Whether the quantum absorption and emission of light may one day be understood in the sense of full causality, or whether a statistical tail is to be left... I would be very unhappy to give up complete causality." On April 29, 1924, Einstein wrote to M.Born: "I shall not give up until there is stronger evidence against strict causality than has so far been presented... I cannot tolerate the idea that an

illuminated electron should jump away at a time and in a direction of its own choosing by its free will... It is true that I have repeatedly failed in my attempts to give quantum definite form, but I do not want to give up hope for long." In 1924, in a letter to M.Born, Einstein added; "The theory of quantum mechanics makes a great contribution, but brings us no closer to the mystery of God. In any case, I'm sure he's not rolling the dice." ...His words spread far and wide, but they are not true; "God" (nature) not only rolls the dice, but often in unexpected places.

In March 1927, W.Heisenberg proposed the famous uncertainty principle in quantum mechanics, which tells us that there is always an irresolvable uncertainty in the behavior of microscopic particles, that is, events in the microcosmic world often happen for no reason. In fact, it is quantum theory that poses the greatest challenge to determinism. Beginning in October 1927, Einstein expressed his rejection of the uncertainty relation and devised "thought experiments" to prove that the principle of the relation could be exceeded. This process continued for at least a decade, including the famous EPR paper. In short, uncertainty relationships lead directly to unpredictability. The quantum world breaks free from the tight chains of cause and effect. "According to quantum theory, it is possible to have an effect without a cause," says British physicist P.Daves. Zhang Yongde^[43], a famous quantum mechanic in China, said quantum theory opposes Einstein's objective realism because its view of things is simple and mechanistic, departing from the principle of superposition of states and wave-particle duality. In addition, what QM does not allow is relativistic local causality, the theoretical basis for the invariance of Lorentz transformations. Therefore, quantum theory can also be considered incompatible with relativistic local causality."

The development of science before QM was proposed actually predicted the end of certainty through the study of randomness and chaos. In the late 19th century, H.Poincare found that the solvability and solution value of some differential equations (such as Hamilton equation type) are sensitively dependent on their initial conditions—small changes in the latter can lead to great changes in the value of the solution or no solution. This discovery made predictability a non-rule and was philosophically opposed to Laplace. Therefore, Poincare moved toward the theory of indeterminacy, which holds that any small uncertainty factor in the state of a system may gradually become large and make the future unpredictable. One of Poincare's contributions was the study of the three-body problem, which led to the discovery of a new concept, chaos, in the analysis of celestial orbits. Like other scientists before him, he did not succeed in solving equations and finding quantitative solutions, but broke new ground in qualitative research. He proposed the concept of phase space, a hypothetical dimensional space, in which each point represents a state of the system. The analytical conclusion is that asymptotic solutions have an infinite number of sequences with different periods, as well as an infinite number of aperiodic sequences—the latter being chaos, which is sensitively dependent on initial conditions or states. He was fond of saying that "prediction is impossible".

In 1933, the chairman of the Nobel Physics Committee said in his speech, "In the microcosmic world, the requirement of causality must be abandoned. The laws of physics express the

probabilities of events. "I think this could not be more true. In the microcosmic world, if the arrival of a particle is an event, it can be said to have no cause.

Quantum mechanics, though it shows how microscopic particles behave in the quantum world, contrary to deterministic causality. But still some researchers, after publishing a good paper on faster-than-light speeds, nervously ask, "Is causality a line scientists should not cross?" This is not a surprising question, since the term "violation of causality" is a common criticism of faster-than-light research. Some relativity books exaggerate the role of causality, but fall into a logical paradox, when they explain the principle of the speed of light limit. It seems that "superluminal speed is impossible" can be judged from causality. In this way SR does not work.

The timing order (positive order $\Delta t > 0$, reverse order $\Delta t < 0$) has relatively property, only $v < c$, the timing has absolute significance, when $v > c$ timing inversion may have observational significance. On the other hand, it is necessary to distinguish temporal relativistic properly from "backward flow of time", and as long as light is used as the method of observation information transmission to observe faster-than-light motion, the reverse order will appear, which is a new expression of causality under the conditions of faster-than-light motion, rather than the destruction of causality. In short, there is no relative change in timing order under the condition of subluminal motion. Moreover, SR treats ds^2 as an invariant, which in fact only applies to sublight systems, and ds^2 is not an invariant when considering the possibility of superluminal motion. In some literatures, the time-sequence relativistic property that must exist when the superluminal motion occurs is described as the backward flow of time, which causes great confusion in understanding. The practice of sanctifying both causality and SR at the same time has blocked and blocked reasonable discussion.

The author believes that observing tachyon motion with light must produce superficially strange phenomena. Aeroplanes flying at supersonic speeds have been realized for a long time, and no one cries "causality is destroyed" because of the reverse sound, and no one thinks that the sound is "transmitted to the past". The key is to recognize the local characteristics of SR theory—its space-time takes light signal as the observation horizon, and the speed limit is set at the speed of light. Light defines time and takes light as the basis of observation theory. This leads to the conclusion that faster-than-light speeds violate causality.

In fact, the discussion of causality does not have to start from quantum reality. Starting from classical physics, as long as some old viewpoints of laws are corrected, negative velocity and advance wave can be analyzed satisfactorily. Liu Liao's argument is an example of this^[44]. He acknowledged the impact of experiments on existing theories and argued that the limitations of theories should be clarified and ways to improve them should be considered. As a noted expert on relativity, he made a notable statement that the Wang's experiment^[20], which contained the possibility of faster-than-light pulses of light, was a challenge to relativity. Specifically, the appearance of negative velocity actually transforms a delayed (conventional) light pulse into an advanced one, resulting in the outgoing pulse being ahead of the incident pulse in time, which seems

to violate the conventional temporal causality, that is, effect is ahead of cause in time. Prof. Liu held that the limitation of time sequence should not be absolutized, but the law of causality should be expressed as "effect cannot affect cause in any way". In this way, the objectivity of the law was maintained (people cannot change history) and the new experiment was explained. In addition, Prof. Liu suggested using the concept of "advanced waves to explain Wang's experiment, which is consistent with the viewpoint of this paper.

In short, it is no longer valid to use the so-called "law of causality" to suppress new ideas in physics. It must be noted that papers published in 2019 have proposed the following: quantum time is in a superposition state, where past, present and future are integrated, cause and effect are reversed, and cause and effect cannot be distinguished. This means the same thing as the speech given by the chairman of the Nobel Committee in 1933.

10 A discussion on "time travel"

"Time travel", also called "time machine", has always been a hot topic among people. There are a lot of strange theories about time travel. Such questions as "can time be turned back?" and "can man go back in time?"

It's important to mention the famous "grandfather paradox"—someone who goes back in time, finds his unmarried grandfather who is in love and kills him; That person would never have been born. If he didn't exist, how could he "go back in time and kill grandfather"? This paradox is often used to prove that it is impossible to travel back in time. ... There is also a paradox with time travellers who want to travel to the future—someone knows they will have a car accident in the future and takes measures (such as staying at home) to avoid it, so the accident does not happen. But since nothing has happened, how can that person be sure that "one day he will have an accident"? ... These points actually rule out the feasibility of "time travel".

So what do the relativists think? There are two theories: One is: "it is relativity that makes time travel possible"; The other is "since relativity says that faster-than-light speeds are impossible, time travel is also impossible." A common saying is "going beyond the speed of light leads to going back in time". Again, people say "particles that travel faster than light can move backward in time". In short, some people do not hesitate to equate faster-than-light with "moving backward in time", or "moving backward in time", or "being able to travel backward in time." And they generally say", This is the result of relativity."

On closer inspection, we find that these statements correspond to Einstein^[2] paper in 1907. It first gives a formula for the speed of the signal, then a formula for the transmission time; And it is proved that under certain conditions these formulas may get negative results, that is negative transmission time and negative signal speed. According to Einstein, this transmission mechanism causes "the effect to arrive before the cause" and therefore "no such signal can be transmitted faster than the speed of light in a vacuum. "He added:"although such an outcome is acceptable in terms of its transport alone, there is no contradiction in it; But it is so alien to the character of all our

experience that "the impossibility of the hypothesis $u > c$ seems sufficiently well established."

Thus, the so-called "move backward in time", or "move backward in time", is the counterpart of negative transfer time in Einstein's paper. Einstein's conclusion (the impossibility of faster-than-light speeds) should result in the impossibility of both negative travel time and negative signal speed. In this case, one should say that "SR considers neither backward nor backward time to be possible", i.e., the construction of a "time machine" is impossible. Yet people like to say that "Einstein's theory of relativity makes time travel possible".

Much has been written about time travel, and it is generally believed that forward travel (to the future) is hopeful, but that going back in time is impossible. The question is whether negative Velocity (NPV and NGV) experiments have proved its existence. This form of faster-than-light speed exists. Can a time machine be made? It has been suggested in the literature that Wang's NGV experiment^[20] can be regarded as a time machine^[40]. In 2011, Professor Cao Zhang said that even if the speed of light is proved to be faster, it would be impossible to build a time machine and travel back in time. His argument is that under the generalized time definition of the Generalized Galilei Transform (GGT), simultaneity is absolute and faster-than-light motion does not cause time inversion. By this he meant a kind of true time; Faster-than-light does not destroy causality under this definition, but relative time as defined by SR is no longer valid. ...But what he didn't realize was that the success of the negative-wave velocity experiment seemed to give new impetus to the "time machine".

The quantum post-selection effect, proposed by the American physicist John Wheeler and also called the delayed choice experiment, was published in 1979. It means that the observer's choice can affect the photon's previous behavior, and that the upcoming event interacts with the completed event. In recent years, European experiments have proved that post-selection can affect photon characteristics at the nanosecond level, so it is believed that the post selection could change the entire history. On this basis, some physicists proposed that quantum time machine could be built by using quantum entangle. There are quite a few people who think so.

Wheeler's idea of "delayed selection" can be transformed into an experiment in which a light source is dampened so that it emits only one photon after the previous one hits S.S appears as a random pattern at first, but gradually appears as interference streaks as the number of photons increases. In this regard, if it is considered that the emitted photon interferes with the photon that has reached S, it means that the event that has not yet happened interacts with the completed event, which violates the law of causality. Therefore, it can be said that each photon interferes with itself, and this can only be done if the photon passes through the double slit at the same time. It is impossible for two photons to travel two paths at the same time in classical physics, which shows that the photon has a strange property.

In order to study time travel using quantum principles, it is necessary to understand the nature of the "quantum post selection" phenomenon. The approach taken by Lloyd in 2010 uses the following quantum effects—quantum particles (such as photons or electrons) are not bounded by the

arrow of time. For example, the future of quantum particles can affect the past. In Heiler's experiment, an unobserved photon passes through two slits at the same time. We know that a photon can pass through both slits at the same time because an interference pattern appears on the terminal screen; If a photon passes through a single slit, it won't.

Europeans have shown experimentally in recent years that post-selection does affect photon properties on a nanosecond scale, Hence the saying that "the post selection process could even change the entire history of the universe"; But I think this is a bit of an exaggeration. The method suggested by Lloyd-Steinberg^[45]; everyday experience, they argue, tells us that the state of our beginnings determines the future. But quantum particles can't tell the difference between forward and backward time. This also means that determining the future state can determine what happened before it. ...C.Bennett and B.Schumacher had previously suggested that quantum entanglement could be used to build a time machine. Using two particles, such as photons, makes them so closely related that they share existence. Entangled particles are special because a measurement of one affects the other particle, no matter how far apart they are. Now imagine teleporting a third particle from A to B; The trick is to create a pair of entangled particles and place one in A and the other in B, and then make a series of measurements in both places. If this can be done, it ensures that the second particle will end up in the same state as the space traveler.

Precisely, the traveler's body doesn't move, but the quantum information completely describes the traveler to complete the journey, allowing the second particle B to assume traveler status. What's curious is that this teleportation happens in an instant. In the process, quantum information goes from point A to point B. Therefore, it is natural to think of completing the journey only by taking measurements at point A. But since teleportation is instantaneous, this is merely a basis for considering the trip triggered by point B, even if it happens later. Figure 6 shows Alice, a girl in the "present", asking Bob, a boy in the "future", to send her a message via quantum teleportation. In the figure, Alice and Bob have entangled photon pairs (both called A); After: □ Alice sends a message (which is decoded as photon X by measuring the entangled photon); □ Bob gets a message when he measures his own photon; □ the post selection action indicates that it is measured by Bob in the future, causing Alice's photon to have this property; □ according to the post selection effect, it is equivalent to Bob sending a message in reverse time. ...This is post-selection at work, and it has the characteristic that, like quantum computing, quantum physics uses all the time to do things. It is this fuzzy relationship between cause and effect that Steinberg and Lloyd developed their time-travel simulator.

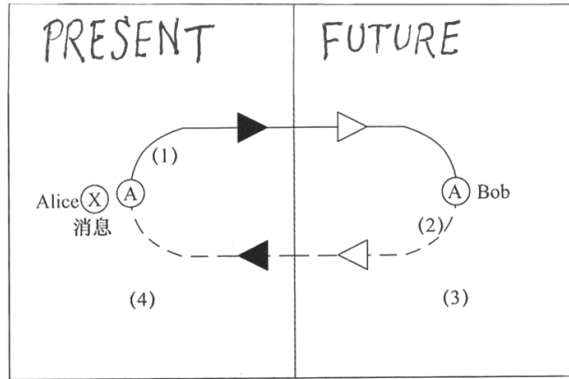

Fig. 6 Diagram of post quantum selection action (A、A are entanglemen pair of photons)

It is an exaggeration to call it time travel. Perhaps, in the same way that quantum teleportation conveys the state of the quantum rather than the material itself. However, Lloyd and Steinberg argue That "the logic of post-selective teleportation is consistent with time travel, so our experiment is a time travel simulator. However, it cannot take one back to the age of the dinosaurs, and it has a lot of special things to do." One of the first things the Lloyd and Steinberg team did was simulate the grandfather paradox by sending the photon back to kill itself. Using teleportation to do this is an important twist. Traditional quantum teleportation is guaranteed to give you a copy state of the intended transmission. Lloyd and Steinberg wondered if this would work for photons to kill themselves with quantum guns.

From a practical point of view, their simulation requires two additional features: a quantum gun capable of firing bullets; And a way to spontaneously stop the transmission process. The team also decided that instead of tracking two photons, as is common in quantum teleportation, they would track two properties of a single photon. Specifically, the way a photon is polarized represents its "present" state, while its direction of motion represents its "past" state. Based on this, they would pair the photon with a quantum gun that could either fire a bullet or spontaneously terminate the quantum transport process. This device, also known as a wave plate, changes the way the photon is polarized. This is because the photon's polarization and direction of motion are tracked, and the photon is also outfitted with a quantum gun to influence its "past" state.

Now, how do you make sure that the transmission can stop automatically if necessary? This is actually easier than the previous task, because quantum teleportation itself has a built-in termination mechanism. Unless it is measured in a special way, the quantum is actually working for only 25% of the time during the transmission. So, in this experiment, there are actually four possible outcomes, depending on the transport process and the state of the quantum gun.

And after this experiment, something interesting happens: At each individual point in time, if time travel is set in motion, the quantum gun can't be set in motion. And once time travel doesn't start, the quantum gun works. From the perspective of the grandfather paradox, if there's a reasonable chance that your gun won't fire and the alleged assassination attempt fails, time travel

can start. "You can aim the gun, but you can't pull the trigger", Lloyd says.

Lloyd and Steinberg's experiment has piqued interest in time travel, especially since it doesn't rely on the space-time warping, closed time-like curves of general relativity, or on black holes, wormholes, and many worlds. New thinking builds on quantum-post selection and the idea that time travel is theoretically possible.

Finally we must say that "going back in time" is not possible anyway. But we have no objection to continuing the discussion.

11 "Negative characteristic electromagnetic wave motion" is a unique phenomenon in nature

When we use the classical-mechanics analyze the motion of substance, who has inherent mass and shape, the velocity is vector, then the negative velocity express backward direction. But when we discuss the motion of waves, who has not inherent mass and shape, the velocity is scalar, the negative velocity does not obey that rule, i.e.does not indicate only the direction of movement is flow backward. But what does that phenomenon mean? The negative wave velocity (NWV) means that, for example, a pulse propagates in special medium with a negative group velocity (NGV) of c/n_g ($n_g < 0$), then it is not only faster than a pulse travelling in vacuum, but so quickly that if left the medium before it had even finished entering. In 2013, we establish the concept of "negative characteristic motion of electromagnetic waves"^[7], and we differentiate it from the meaning of "movement in backward direction". We must receive the advanced solution of D'Alembert equation, and understand the concept of negative wave velocity. The truthful and rich of Nature give a lesson for us, and she will still instruct us continually in the future.

The dualistic nature of matter is basic feature of the world; and the possibility of electromagnetic parameters in modern physics become negative value or negative characteristic motion of electromagnetic waves can exist everywhere. The positiveness and negativeness of physical parameters are one of symmetry in nature. Then, the study on this investigation area is the new way for research of objective laws. As part of the research of wave science, the author not only focuses on the theory and experiment of the study of negative electromagnetic parameters, but also discusses the negative motion of electromagnetic waves.

These rules have not been included in the symmetry and conserved quantities table in physics, but were related only in the concept of chiral symmetry. We believe that the positive or negative physical parameters and the positive or negative motion. of electromagnetic wave are one of the symmetry mechanisms in nature. The term "negative characteristic motion" proposed by the author has a profound connotation, which is different from the simplistic "changing direction".

As mentioned above, J.Wheeler and R.Fleyman were the pioneers in the study of electromagnetic field advanced solutions and electromagnetic wave advanced waves, but I think their work is not good enough, and hopefully their view is wrong. Therefore, we try to make a more comprehensive generalization and a deeper elaboration under the heading of "negative

characteristic motion of electromagnetic wave". Of course, we do not deny Feynman's contribution.

Feynman noted that electromagnetic radiation had been interpreted before him in terms of "an interaction between a source and an absorber". For example, H. Tetrode^[46] believed that if the sun in the solar system were alone and had no other absorber of radiation, it would not radiate. The presence of an absorber is essential to the mechanism of radiation. ... Feynman's analysis is based on the following assumptions: (1) In a charge-free space, an accelerated charge does not radiate energy; (2) The field action on a given particle is caused only by other particles; (3) These fields are represented by the sum of half delayed solutions and half advanced solutions. He called the subject he studied "advanced effects of the theory of action". In the paper's only illustration ("Example of advanced effects in an incomplete absorption system"), the general picture is divided into eight smaller graphs with the following instructions: "Incident waves before source acceleration; These incident waves are absorbed; The incident wave will act on the source at the time of acceleration; The source is acted upon by: colliding particles or other forces or incident waves; The source radiates waves; Some radiation waves are absorbed; The waves that continue outward leave forever; The outward wave looks like an incident wave that continues through space in addition to the change of sign". ... Here, his so-called incident wave does not seem to be an alien wave, because space has only 1 source; It is like the wave that returns to the source, the one that reacts.

In 1965, Feynman said of his view of time (past and future): "We can remember the past, but not the future; What we can do to affect the future, but not what we can do to affect the past. ... The whole world seems to be moving in one direction. But in the laws of physics there is no difference between the past and the future. The laws of gravity, the laws of electromagnetism are reversible in time". It can be seen that Wheeler and Feynman boldly proposed a "time-symmetry theory of half retarded wave and half advanced wave" in 1945, that is to say, when trying to reveal the interaction mechanism of particles, in order to avoid the contradiction between the past and the future, inward moving waves (waves moving backwards in time) must be used to make the theory symmetrical.

Wheeler-Feynman's absorber theory is similar to the cut-off waveguide theory^[8] discussed in detail by the author. It can be shown that two reactive storage fields interacting with each other can produce some active power, while a single field cannot. This interaction suggests that nature has some strange properties, just as the presence of a single tree is different from that of placing it in a forest with many trees! ... Although previous studies have not found the existence of negative Motion (or advanced wave) in^[11] simple mutual inductance coupled AC circuits, we have found that the phenomenon of negative phase constant ($\beta < 0$) in cut-off waveguide theory is actually a kind of lead wave. In addition, recent studies show^[12] that the antenna near-field has evanescent-state like conditions, and the resulting superluminal-light group velocity or even negative group velocity (NGV), which is the "negative characteristic motion" of electromagnetic wave! The above association gives people a feeling of "dawning light". However, we do not agree with the idea of "canceling the retarded wave with the advanced wave".

Some one say inward waves were found on the basis of the rapid development of so-called

left-handed material in recent years^[47]. However, the phenomenon of inward propagation of waves does not exist only under LHM conditions. For a radiation source, the near-field and mid-field dynamics of vector electromagnetic fields are far more complicated than the simple understanding (outward propagation). In the near field region of the source, there may be a phenomenon that the main body of the waveform moves inward. N.Budko^[14] had demonstrated this phenomenon with experimental observations, which he believed was negative waveform velocity, and the relevant waveform was travel back in time. These conditions were independent of LIIM. This goes back to R.Feynman and J.Wheeler's 1945 paper, before Vesselago^[48] had even been written, let alone LHM. However, the idea of advanced wave had already been proposed, which was worth thinking about.

From 1958 to 2004 some people simply concluded that "backward waves' meant' the vector direction of the phase velocity is opposite to that of the group velocity" but we have pointed out that it is not appropriate to think of negative velocities uniformly as "motion in the opposite direction". Negative group velocities (NGVS) have a vivid physical manifestation that cannot be described by a simple "directional judgment". For example, when an impulse incident into the NGV medium is compared with an impulse coming out of the NGV medium, the outgoing pulse may be timed ahead of the incoming pulse (the outgoing pulse appears before the incoming pulse arrives). This "advanced phenomenon" leads to a new interpretation of causality. If the output pulse is regarded as "effect" and the arrival of the input pulse as "cause", the experiment proves that "effect precedes cause" can occur. ...One cannot understand new things and new phenomena by clinging to the old doctrine of "the law of cause and effect".

12 The important contributions of John Bell and Alain Aspect

A.Einstein, who completed his work on the theory of relativity in 11 years from 1905 to 1916, is regarded as "the greatest genius of the 20th century". However, in my 2022 paper^[49] I have pointed out that SR is hardly Einstein's independent creation—H.Poincare's papers in 1900 and 1904^[50], and H.Lorentz's papers in 1904^[51], contain the ideas on which SR is based, but Einstein has not explained them in his papers [37]. Einstein never wrote his papers without a table of references. Whether he had read the two great scientists before 1905 is known only to Einstein himself. We judge, of course, that he did. Although Einstein mentioned Lorentz several times after he became famous, Lorentz's ideas did not coincide with his—hence the recent term "Lorentzian Relativity." Lorentz is known as a modest gentleman who does not compete with Einstein for "priority". As for Poincare Einstein never mentioned it after he became famous, as if he didn't exist; In fact, the formula $E=mc^2$ was derived by Poincare in 1900, and even the Lorentz transform (LT) was named after Poincare. ...We do not mean that Einstein is a plagiarist here, for his own reasoning is often riddled with myths^[38, 52, 53], and only a person who has not worked hard would blindly praise Einstein's greatness.

Quantum mechanics (QM) was established in the three years between 1926 and 1928. It is truly a collective product, with the involvement of E.Schrödinger, W.Heisenberg, P.Dirac, M.Born,

N.Bohr, and others. The approach of QM is different from that of relativity—although it is also based on rigorous mathematical analysis, its physical concepts are deep and clear, and not at all intended to show off the esoteric use of mathematics. QM is the epitome of scientific beauty! ... As soon as QM came out, Einstein was immediately alarmed and tried repeatedly to refute it and make it untenable. However, events that followed were completely out of Einstein's control, and QM went on and on, attracting countless physicists and opening up numerous applications. Thus, the creation of QM was a real threat to relativity!

In 1935, Einsteins^[54] published his famous EPR paper, which focused on delivering a fatal blow to QM. It was a sign that the conflict between relativity and quantum mechanics had reached fever pitch. The paper was published in the journal «Physical Review» and signed by Einstein, Podolsky and Rosen, so it is called the EPR paper. On May 4, 1935, the «New York Times» published a headline on its front page saying: "Einstein attacks Quantum Theory", This is a sensation. The EPR thesis is against quantum theory (QM), SR and QM these two views of the world, time and space the decisive moment has arrived.

Some of the content in the EPR paper is merely foreshadows (e.g., saying that the physical theory must not only be correct but also "complete"; Or that the description of reality given by the wave function in quantum mechanics is "incomplete"). The fundamental thing lies in the analysis of the interaction of "two-system systems"(systems of two subsystems). Here, subsystems I and II should be understood as microscopic systems, such as particles. The states of the two subsystems before $t=0$ are known. Between $t=0$ and $t=T$, they interact with each other. When $t>T$ they no longer interact with each other (for example, move away—separate in different directions). Let $\Psi(x_1, x_2)$ be the quantum state of the system, which can be expanded in terms of the eigen function system for measuring A physical quantity (such as a mechanical quantity) of I, or in terms of the eigen function system for measuring a physical quantity of I. According to quantum mechanics, the wave packet $\Psi(x_1, x_2)$ will collapse during measurement, and will be condensed after measurement, resulting in a state that will affect II when measuring I. But I and II have been separated, so this strange effect of action at a distance is impossible. Because the special theory of relativity stipulates that the interaction of nature can only be realized at less than the speed of light, a system separated by space should be local, but quantum mechanics gives the non-local case, so quantum mechanics is not self-consistent and incomplete. These are the most important things in the EPR paper.

It follows that there is an invisible thread that connects special relativity and EPR; It can also be said that EPR thinking is based on special relativity. Secondly, we say that special relativity is in sharp contradiction with the world view of quantum mechanics, precisely in the question of "local realism or non-local realism". The EPR paper was Einstein, at the age of 56, giving quantum mechanics as much of a blow as he could possibly hope for with his wisdom.

Einstein believed that the EPR paper would refute Heisenberg's uncertainty principle and prove that quantum mechanics was imperfect. The discussion of "two systems" (I and II) in EPR

seems to imply that it is possible to "know both position and velocity", since the velocity of I is the velocity of II.

After the article was published, N.Bohr began to refute it. Bohr meant that the setting in the EPR paper could be rejected—uncertainty affected both I and II and II was immediately affected when I was measured to make the result consistent with Newton's law; This effect occurs immediately, even if I and II are far apart.But younger scientists, such as Heisenberg, can't argue with Einstein the way Bohr can.

Russian academician V.Fok said:"It is particularly amazing that Einstein, who did a lot of work for quantum theory in its early days, has taken a negative attitude towards modern quantum mechanics. There is no direct force interaction between the two subsystems of EPR thinking, and one can also affect the other, which Einstein considered incomprehensible, and thus considered quantum mechanics incomplete."

According to Fok, the interaction (influence) of Pauli's principle in QM is an example of a non-force. The interaction (influence) between two particles with a common wave function (EPR system) is another form of non-force interaction (influence) in quantum mechanics. The existence of non-force interactions (influences) is beyond doubt, and it would be wrong to negate such interactions.

So how do you decide whether the EPR paper is right or wrong? This is a difficult thing to do in the early days. John Bell, an Irish physicist [who has since worked at CERN, the European Organisation for Nuclear Research], was not sure whether the EPR paper was right or wrong. He even wanted to come up with a new theory to make it more convincing. Since the EPR centers on the-analysis and judgment of two-particle systems and argues that quantum entanglement cannot be maintained, this is where it begins. In 1965, J. Bell^[55] proposed a hidden. variable model compatible with quantum mechanics, holding that "no local variable theory can reproduce all the statistical predictions of quantum mechanics", and proposed the inequalities that should be satisfied between some correlation functions when two particles do spin projection along different directions of space-time:

$$|P(\mathbf{a}, \mathbf{b}) \cdot P(\mathbf{a}, \mathbf{c})| \leq 1 + P(\mathbf{b}, \mathbf{c}) \quad (33)$$

and he also said, was not only experiment proves this type, to prove QM correct and relativity (SR) is wrong. So, it is J.Bell make conflicts and arguments between SR and QM had to judge by experiment. Therefore, Bell's 1965 paper was a landmark.

Bell's theorem says that a hidden variable theory cannot reproduce all of QM's predictions. ... But exactly how this is the case must be determined by experiment. The breakthrough was made possible by precise experiments by French physicist Alain Aspect^[56], he led experiments that demonstrated, with high precision, that the results greatly violated the Bell inequality and were in good agreement with the predictions of quantum mechanics. The fact that the Bell inequality was disproved by precise experiments meant that the EPR paper was wrong and quantum mechanics was

right. In a manner of speaking, Bell opened the door to quantum informatics technology research!

Bell had been a staunch supporter of Einstein, believing in physical reality and locality. He believed that some hidden variable was responsible for the mysterious action at a distance in quantum mechanics. In fact, it is possible to construct a theoretical inequality to which observations of particles must follow, thus proving the incompleteness of quantum mechanics described in the EPR paper. Bell's analysis builds on Bohm's spin-dependent scheme and the theory of hidden variables. We now dispense with the mathematical analysis and simply point out that Bell's inequality is inconsistent with quantum mechanics!

Bell was still a proponent of Einstein's theory when he presented his theory in 1965. Twenty years later, in 1985, he was an opponent. He gave a clear answer to the BBC, arguing for the existence of a preferred frame of reference, i.e., the ether. He argued that superluminal speeds of light were possible, that relativity was an obstacle to the development of quantum theory, and that Einstein's worldview was untenable. In short, he argued for going back to that before special relativity, i.e. Poincare and Lorentz situation.

Bell made his comments in connection with special relativity and the EPR, because both theories are relevant to what view of nature and the universe we adopt. The EPR began as an argument against quantum mechanics and ended in failure. The turning point was the Aspect experiment of 1982; Quantum informatic technology developments over the next 40 years further doomed Einstein's theory.

As can be seen from the progress in the study of quantum entangled states, the world view of quantum mechanics has completely defeated the world view of special relativity. The entanglement distance between the two photons in the successful experiment has gradually developed from 15m at the beginning (Aspect) to 25km, and even 144km(10 years ago). The June 15, 2017 issue of «Science» magazine reported that a team of Chinese scientists have made a new achievement with a quantum satellite–quantum entanglement on the scale of the order 1,000 kilometers (1,303km from Delingha Station in Qinghai Province to Gaomeigu Station in Yunnan province). The result has taken the world by surprise. All in all, a series of experiments perfectly demonstrated that special relativity had a problem with space-time.

Since 1965, the Bell Inequality has been widely verified and has become an important means for identifying entanglement that can be described by discrete measurements. For example, measuring the spin direction of one quantum particle and then determining whether this measurement is related to the spin of another particle. If a system violates this inequality, then entanglement exists! In short, the Bell inequality became an iconic test to see if it was obeyed. Both theory and experiment show that nonlocality is a fundamental characteristic of quantum mechanics –experimental results that violate Bell inequality indicate the existence of nonlocality. Bell's name entered the history of science when his inequality was hailed as "one of the greatest scientific discoveries in human history".

At the opposite end of the spectrum is the classic, macroscopic, and locality nature of relativity

(mainly special relativity SR). The main contents of this locality realism are: believe in classical physical reality, believe in localized causal rate, and oppose probabilistic thinking; That the speed of light is the limit of the speed of moving bodies and the speed of information propagation in the universe; And does not admit the possibility of entanglement in physics.

In the first week of October 2022 came the exciting news that the 2022 Nobel Prize in Physics had been awarded to physicist Aspect and two others. They were honored, the awarding body said, "for their experiments on photon entanglement, their determination that the Bell inequality is not true, and their groundbreaking work in quantum information science." "All three scientists have performed quantum entanglement experiments," Reuters news agency reported. In quantum entanglement experiments, two particles stay connected no matter how far apart they are. This bothered Einstein, who called it spooky action at a distance."

Now, Aspect is a old man. The significance of this award is not only to support quantum mechanics (which is the same as in 1933), but also to encourage the research and development of quantum communication, quantum computer, quantum radar, which is a landmark significance. Of course, it is also a blow to those who have denied Aspect experiments for a long time, and they have always been unwilling to accept the failure of relativity. Bell might have been entitled to the prize, but he died in 1990, and the Nobel Prize can only be awarded to living people. In fact, whether the prize itself is not important, he key is to establish a correct view of time and space.

John Bell put forward the theory of hidden variables in 1965 and gave inequalities, which was to support the theory of relativity. The results were contradicted by Aspect's precise experiments (and later supported by multiple experiments). In addition, considering the implications of the discovery of the cosmic microwave background radiation, he finally announced his departure from relativity in 1985, showing the integrity and courage of a scientist. J.Bell was one of the great scientists of the 20th century. FIG. 7 shows him giving a lecture.

In short, quantum entanglement, a physical phenomenon known as action at a distance (infinite velocity), was finally recognized by the great developments in quantum information technology that led the Nobel Committee to recognize the groundbreaking significance and value of the 1982 Aspect experiment, so to award the 2022 Nobel Prize in Physics. Therefore, some people say that this award is a rejection of Einstein's "light speed limit theory", and I think this view is correct.

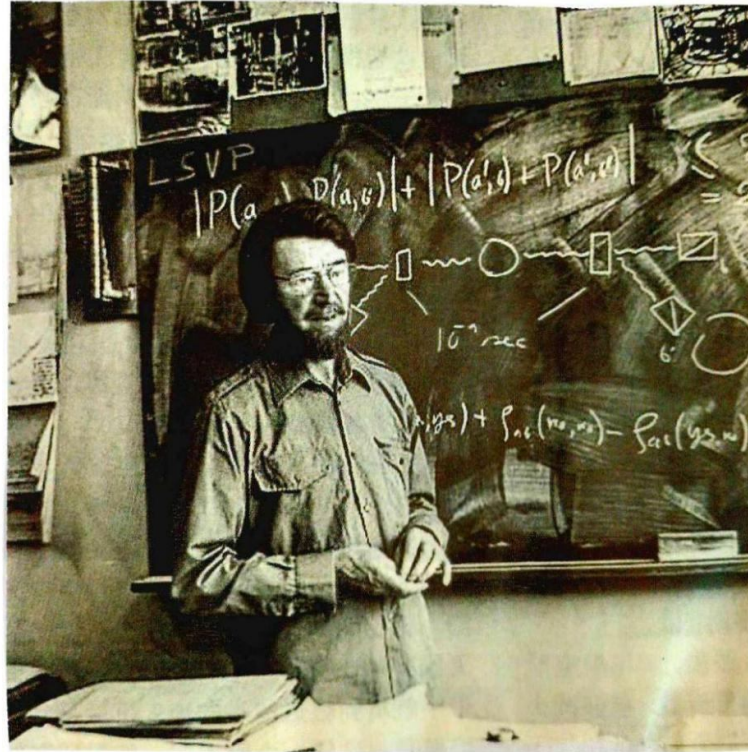

FIG. 7 John Bell, an Irish physicist with outstanding scientific ideas, is giving an academic lecture (His famous inequality is written on the blackboard).

However, quantum entanglement is not action at a distance. In other words, the entangled state does not travel at an infinite speed, but at a finite speed. And this speed is superluminal, which Salart^[57] proved experimentally in 2007, $v = (10^4 \sim 10^7) c$. That's a lot, of course, but it's by no means infinite. As for the negative velocity, it has not yet been observed in quantum entanglement. All in all, Aspect's winning the Nobel Prize after 40 years is a criticism or even a denial of Einstein.

13 Will faster-than-light space travel be possible in the future?

There was a very special academic conference on «Frontier Issues on Astronautics and Light Barrier» held by the Chinese scientific community in Beijing, from 26 to 28 November 2004; This conference was attended by about 50 scientists of different professions, including mathematicians, physicists, electronics scientists, astronomy and astrophysicists, and aerospace technologists; The advocate and organizer was Academician Jian Song, who used to be director of the State Science and Technology Commission of China, president of the Chinese Academy of Engineering, and vice minister and chief engineer of the Ministry of Aerospace Industry. The meeting took aim at Einstein's theory of the "limit of the speed of light". In his keynote speech, Song pointed out that in the future, humans should be able to travel beyond the solar system and explore further afield, even

to distant galaxies. However, the current level of science and technology is still low, and the speed of rocket flight is far from the speed of light ($v \ll c$), so Song^[58] cautiously said:

"As a consequence, the speed of travel has to be increased to the magnitude of the speed of light or, if possible, to enable astronauts to complete a round trip in a couple of years. It will take 4.4 years to go to and return from A cen with an average speed of $0.8c$. It takes 4.2 years to go to and return from Sirius (8.6 light-year away) with acceleration and deceleration limited to $2g$, and maximum flight velocity of $0.94c$."

His argument is not science fiction, but the expectations and aspirations of an old aerospace expert. Some theoretical physicists have argued that faster-than-light spacecraft are completely impossible from an energy calculation point of view and defy scientific logic. But in ancient times, the consensus was that it was impossible for humans to land on the moon—this was the "scientific logic" of the time, due to the low level of science and technology.

According to J.Song, from the experience of space technology practice, the way and angle of thinking today are different from those in the past. He said:

"The space flight developed in the past 40 years provided new ways of observation and experiment. Missiles, satellites and spacecraft can all be equipped with atomic clocks, navigation instruments, optical and radar facilities for timing, positioning, orientation, tele-metry and communication, etc., and all fly on their own, or autonomously. Ground-based observation is just complementary, at least not a necessity for a space flight theoretically. The space flight enables people to examine the meaning of the theory of relativity and its inferences from a new angle.

Mechanics. However, it attracted little attention of the science community who thought it to be too far from the reality and something in the distant future. If we examine the engineering practice of space technology in the past 40 years compared with the assertions of Special Relativity, we could find some obvious conflicts. For the thrust of engine has never been found to be dependent upon its inertial v .

The practice of space technology in the past half century proves that the γ equation is accurate enough at least around the Third Cosmic Velocity ($v_3=16.6\text{km/s}$). The fact that the thrust of engines has never depended on inertial speed has been proved by measurements done on spacecraft in flight with accelerometers and on the ground. That is usually thought to be the case when v is much less than c . However, for the case $v \geq c$ we need evidence -- support from experiments before any theory to be applied into practice. Therefore, we must proceed very cautiously in calculating the flight velocity of spacecraft by using dynamics formula of special relativity."

Thus, building a faster-than-light spacecraft is only a vision of the future, but J.Song's argument gives us confidence. Some cling to the law of causality, saying that to admit faster-than-light would lead to a paradox. The author does not deny that superluminal phenomena tend to cause paradoxes, but this is caused by the connection and definition of space-time with light in the context of SR. An English poem from the past is the most typical example. It says:

"There was a young lady named Bright,
Whose speed was far faster than-light;
She went out one day in a relative way,
And returned the previous night."

—by Reginald Buller

Although the poem is a play, it is consistent with SR's belief that faster-than-light motion cannot exist for one important reason: it would cause time to go back. But relativistic property of time order is different from time travel. We all know that time flows in one direction and irreversible; It is not only impossible to reverse time, but also causes the fundamental destruction of causality. So, wouldn't faster than-light cause time to go back? Relativistic property of time order means that when $v < c$ there is positive timing order, when timing is absolute. Therefore, the constant positive condition of time sequence can be used to describe causality. However, when $v > c$, the inverse time sequence must be observed when the and pass in the same direction, which is the inevitable result when the optical observation information passes. This does not constitute a causal breakdown, but a new statement of causality under faster -than- light conditions. The analysis shows that when $v > c$ occurs $(t_B \cdot t_A) < 0$ in no way means that greater velocities cannot occur, but merely that light rays cannot catch up with faster-than-light particles.

Therefore, SR is actually using the Lorentz transformation (LT) applicable only to sublights to discuss superluminal motion, which is bound to encounter contradictions. In the light of SR, the relativistic time order that must occur in superluminal motion is said to flow back in time, thus confusing temporal absoluteness as a causal condition in physics. Einstein also forgot that LT has a scope. In short, it's not hard to refute the notion that faster-than-light speeds cause time to travel backwards.

Therefore, we believe that, without the use of complex mathematics, it is easy to refute the backward flow of time theory, which can be summarized as follows: timing order (positive order $\Delta t > 0$, reverse order $\Delta t < 0$) is relative—only when $v < c$, timing order has absolute meaning. The inversion of the time sequence of $v > c$ may have observational significance. In addition, relativistic property of time order is to be distinguished from "backward flow of time", which occurs whenever faster-than-light motion is observed by light as a means of transmitting observational information.

J.Song further explained why some experts in space abandoned relativistic mechanics:

"In order to avoid the possible uncertainties of ground measurement the space flight is no longer working the way as postulated in Special Relativity, that is to define distance as half the two-way time interval of electromagnetic wave. Instead, all the information and data are measured, encoded and transmitted by satellite or spaceship itself to the earth. Thus, the timing, measurement of coordinates and speed, navigation and communication on the spaceship are carried out by itself totally independent upon the ground observation. The GPS(Global Positioning System) works well with this principle and proved to be a great success."

J.Song explains in plain English, what exactly is wrong with Einstein?:

"Technically speaking, velocity faster than that of light could not be observed by means of electromagnetic wave. It may only be hypothesized or guessed about the movement without any information about it and nothing could be seen. Einstein conjectured in 1905 that the light barrier could not be passed by any phenomenon, action or particles in the universe. I venture to paraphrase it in this way, so long as the light or electro-magnetic wave is the only means for observation and measurement, nothing can escape from the range of sight. However, we can not see it does not mean its non-existence."

Nothing can escape from the range of sight. However, we can not see its non-existence. It could be. Since the intrinsic speed of electromagnetic fields (the speed of electromagnetic waves) is the speed of light, thinking on this basis must seem strange. If a ship were to leave the Earth at a speed greater than the speed of light, no light (or electromagnetic) signal from the ground would respond, because it would not catch up with the ship. If the ground station was monitoring with radar, it would not be able to see the target. If there is a spacecraft at the speed of light ($v > c$) toward the Earth, the late signal received early. In short, faster-than-light motion cannot be observed with electromagnetic waves. Since "not seeing" cannot be proof of "not being", Einstein's claim that "no object or action can travel faster than the speed of light" is merely a guess, not a scientific law. Ground stations cannot use electromagnetic waves to send commands to spacecraft traveling at or near the speed of light, so future space technology calls on experimental physicists to find signals traveling faster than the speed of light.

The author believes that, when the spacecraft flies at a speed faster than the speed of light, the ground observer will receive the light before it emits, which is indeed a kind of anti-timing phenomenon. However, the relativity of timing should be realized; Timing should not be substituted for causality. After all, flying out of the solar system and striving for faster-than-light space travel are still bold ideas. Since neither Newton nor quantum mechanics put an upper limit on speed, only relativistic mechanics, we must examine the reliability of the latter.

China's Jian Song is certainly not the only scientist who imagines a future in which humans travel faster than the speed of light. In fact, some even expect spacecraft to travel as fast as they want. Even though SR theory has a strict limit on speed, some have suggested that a spacecraft could travel through space at sublights and then manipulate space itself, making it fundamentally faster-than-light. This is what warp drive means, and it comes from a 1991 paper by Acuberre^[59]. In a 2021 paper, I showed that it was not feasible^[60], because it would require enormous amounts of negative energy to warp spacetime. We have shown that Einstein's theory of space-time bending is problematic^[57]; It is impossible to create so much negative energy even if it were not (and we do not know whether negative energy can actually be created). ...There is no need to bypass SR to seek help from GR in the future. because the "speed of light limit" theory of SR itself is not correct! Therefore, the author supports Song's general argument.

14 Concluding remarks

In classical electromagnetic theory, Maxwell's equations are a set of several first-order hyperbolic partial differential equations. From this, the electromagnetic wave equations can be derived, but this is a second order elliptic partial differential equation of the system. To solve these two kinds of problems, the former can be discretized, so that the initial value problem becomes an effective algorithm. The latter is solved by the boundary value problem. Either way, two wave solutions are found—divergent waves moving toward infinity and convergent waves moving toward an electromagnetic source. Today, we call the former a retarded wave and the latter a advanced wave. Although as early as in the 1970s, the Chinese scientific community considered how to treat these two types of waves when designing the antenna, and decided to abandon the converging wave (advanced wave) solutions and only use the retarded wave solution, today the understanding and processing were wrong, although the original intention was to avoid the confusion of the data.

The matter of advanced wave is related to negative velocity, here the negative velocity mainly refers to the negative wave velocity (NWV). It is difficult to discuss the negative velocity of macroscopic matter, so this article will not focus on it. When the motion of a material object is analyzed by classical mechanics, the velocity is a vector, and the negative velocity generally indicates the opposite motion. But for the motion of waves without mass and invisible, the velocity is scalar. It cannot be said that the negative velocity only represents the reverse direction of the flow. For a negative wave velocity, such as a pulse passing through a particular medium with a negative group velocity (NGV), it is not only faster than the pulse passing through a vacuum, but it is faster than leaving the medium before it enters it. Therefore, we put forward the concept of "negative characteristic electromagnetic wave motion", which is rich in connotation. It is necessary to accept the advanced solution of d'Alembert equation in order to understand the negative motion. Nature, so to speak, teaches us a lesson in her truth and richness.

When the pulse entering the NGV medium is compared with the pulse coming out of the NGV medium, the outgoing pulse is preceded in time by the incoming pulse (the outgoing pulse appears before the incoming pulse arrives). This "advanced phenomenon" leads to a new interpretation of causality. Its emphasis is no longer "cause precedes effect", but rather "effect cannot affect cause or react on cause". This is a new understanding within the framework of classical physics. In the realm of quantum physics, causality is inherently disproven. It is pointed out in this paper that there are two kinds of basic electromagnetic environments in the near field—bound field and evanescent field; The former includes static field (which decays according to r^{-3} regularly) and inductive field (which decays according to r^{-2} regularly); The latter contains the evanescent plane spectrum, with the field decreasing exponentially as the distance from the source increases. The bound field is referred to as the evanescent field in this paper. In recent years, the phenomenon of electromagnetic wave traveling faster than the speed of light in free space has been found in both of them, and the negative wave velocity has been observed experimentally. The results of recent experiments do not support the commonly held view that propagation at the speed of light ($v = c$) is retarded for bound

fields. Based on the observation of no hysteresis in the near area of the antenna, the non-locality experimental evidence of the bound electromagnetic field is provided. The non-locality property is a quantum mechanical concept, so the non-locality property of bound field can be closely related to classical electromagnetism and quantum mechanics.

This paper emphasizes the new phenomena found in the near-field measurement and gives several theoretical duals. As for the quantum explanation of the near-field faster-than-light phenomenon, it holds that the idea of "evanescent state is virtual photon" should be applied theoretically. An important research area is to obtain inward waves in free space without the use of anomalous dispersion and LHM meta materials.

Finally, it must be noted that the concept of "negative characteristic motion of electromagnetic wave" proposed by the author has three main contents in a broad sense: (1) negative refraction index phenomenon (NRI); (2) negative wave velocity phenomenon (NWV); (3) negative Goos-Hänchen shift (NGHS). Limited in length, this paper mainly discusses (2); For (1) and (3), please refer to literature [61]. In addition, the author's new book of 2022 [62] can also be used as a reference when reading this article.

References

- [1] Born M, Wolf E. Principle of Optics. Cambridge Univ. Press, 1999
- [2] Einstein A. *Jahr der Radioaktivität und Elektronik*, 1907, 4: 411~461
- [3] Sommerfeld A. *Ann.d Phys.*, 1914, 44(1): 177~182
- [4] Brillouin L, *Wave Propagation and Group Velocity*. Academic Press, 1960
- [5] Wheeler J, Feynman R. *Rev. Mod. Phys.*, 1945, 17(2, 3): 157~181
- [6] Budko N. *Phys. Rev. Lett.*, 2009, 102: 020401, 1~4
- [7] Huang Z X. *Jour. of Communication Univ(Natural Sci.)*, 2013, 20(4): 1~15
- [8] Huang Z X. *Introduction to the Theory of Waveguide Below Cutoff*. China Metrology Press, 1991
- [9] Wynne K, et.al. *Opt. Communication*, 2000, 176: 429~435
- [10] Wynne K, Jaroszynski D. *Opt. Lett.*, 1999, 24(1): 25~27
- [11] Davies P. *About Time*. Harvard Univ Press, 1998
- [12] Garrett C, McCumber D. *Phys.Rev. A*, 1970, 1(2): 305~313
- [13] Chu S, Wong S. *Phys. Rev. Lett.*, 1982, 48(1): 738~741
- [14] Hache A. *Appl. Phys. Lett.*, 2002, 80(3): 518~520
- [15] Munday J, Robertson W, *Appl. Phys. Lett.*, 2002, 81(11): 2127~2129
- [16] Huang Z X, et.al. *Engineering Science*, 2003, 1(2): 35~39
- [17] Zhou W, Li Z C. *Jour. of Beijing Institute of Petro-Chemical Tech.*, 2009, 17(3): 48~53
- [18] Yao H Y, Chang T H. *Prog. EM Res*, 2012., 122: 1~13
- [19] Huang Z X, Jiang R. *Frontier Science*, 2014, 8(1): 54~68
- [20] Wang L J, et.al. *Nature*, 2000, 406: 277~279

- [21] Stenner M. *Nature*, 2003, 425: 695~698
- [22] Gehring G, et. al. *Science*, 2006, 312: 895~897
- [23] Zhang L, et. al. *Phys. Rev. Lett.*, 2011, 107(9): 1~5
- [24] Glaser R, et. al. arXiv: 1204. 0810, v1[quant. phi], 3Apr. 2012
- [25] Enders A, Nimtz G, *Jour. Phys. France*, 1992, (2): 1693~1698
- [26] Nimtz G, Hertman W. *Prog. Quant. Electr.*, 1997, 21(2): 81~108
- [27] Huang Z X. *Journal of Communication Univ (Natural Science)*, 2015, 22(5): 1~8
- [28] Tzontchev R. arXiv: phys. 10010036 v1[phys. class-ph], 14 Oct. 2000
- [29] Kholmetskii A. *Jour. Appl. Phys.*, 2007, 101: 023532 1~11
- [30] Kholmetskii A. *Jour. Appl. Phys.*, 2007, 102: 013529 1~12
- [31] Missevitch O, et. al. *Euro. Phys. Lett.*, 2011, 91: 64004 1~5
- [32] Sangro R, et. al. *Ann. d Phys.*, 2014, 44(1): 177~182
- [33] Fan J *Jour. of Communication Univ. (Natural Science)*, 2013, 20(2): 64~67
- [34] Carniglia C, Mendal L. *Phys. Rev.*, 1971, 3(2): 280~296
- [35] Ali S. *Phys. Rev. D*, 1973, 7(6): 1668~1674
- [36] Stahlhofen A, Mimtz G. *Euro. Phys. Lett.*, 2006, 76(2): 189~192
- [37] Einstein A. *Ann. d Phys.*, 1905, 17(7): 891~895
- [38] Huang Z X. *Jour. of communication Univ. (Natural Science)*, 2021, 28(5): 71~82
- [39] Brillouin L. *Ann. d Phys.*, 1914, 44(1): 203~208
- [40] Huang Z X. *Current Jour. of Appl. Sci. & Tech.*, 2021, 40(35): 61~77
- [41] Ulbrich R, Fehrenbach G. *Phys. Rev. Lett.*, 1979, 43(13): 963~966
- [42] Zhang Y Z. *Physics*, 2001, 30(8): 456~460
- [43] Zhang Y D. *Progress of Quantum Mechanics*. Science Press, 2009
- [44] Liu L. *Knowledge of Modern Physics*. 2002, 14(1): 27~29
- [45] Mullins J. *New Scientist*, 2010(20): 34~37
- [46] Tetrode H. *Zeit. f Phys.*, 1922, 10: 317
- [47] Smith D, et.al. *Phys. Rev. Lett.*, 2000, 84(18): 4184~4187
- [48] Veselago V. *Soviet Phys. USP*, 1968, 10(4): 509~514
- [49] Huang Z X. *Current Jour. of Appl. Sci. & Tech.*, 2022, 40(35): 25~48
- [50] Poincarè H. *Archiv Neerland des Sci et Nature, Ser 2*, 1900, 5: 252~278; also: *Bulletin Sci. Math.*, 1904, 28: 302~324
- [51] Lorentz H. *Proc. Sec. Sci. Koninklijke Akad. van Wetenschappen(Armsterdam)*, 1904, 6: 809~831
- [52] Ma Q P. *Inquiry into the Self-constancy of Relativity Logic*. Shanghai Scientific Literature Press, 2004
- [53] Ma Q P. *The Theory of Relativity*. Nova Pub., 2013
- [54] Einstein A, et.al. *Phys. Rev.*, 1935, 47: 777~780

- [55] Bell J. *Physics*, 1964, 1: 195~200; also: *Rev. Mod. Phys.*, 1965, 38: 447~452
- [56] Aspect A, et.al. *Phys.Rev.Lett.*, 1981, 47: 460~465; also: *Phys.Rev.Lett.*, 1982, 49: 91~96
- [57] Salart D, et.al. *Nature*, 2008, 454: 861~864
- [58] Song J. *Aerospace, astronautics and light barriers. The 242nd Symposium of Xiangshan Science Conference*, 2004, 7~40
- [59] Alcubierre M. *Class & Quant. Grav.*, 1991, 11(5): 173~177
- [60] Huang Z X, *Journ. of Communication Univ.(Natural Science)*, 2022, 29(1): 64~80
- [61] Huang Z X. *Wave Science and Superluminal Light Physics*. National Defense Industry Press, 2014
- [62] Huang Z X. *Light of Physics—Open Physical Thought*. Beijing University of Aeronautics and Astronautics Press, 2022

UNDER PEER REVIEW