

Original Research Article

Simulation Study of Bi-metal Strips from a Centrifugally Casted Manufacturing Technique using Ansys

Abstract

This study employs the Finite Element Analysis (FEA) method to conduct an electric resistance test on bimetallic materials composed of aluminum and brass. Bimetallic have properties that are not present in their individual metal constituents. Through centrifugal casting, a bimetal with different compositions of aluminum and brass was generated for simulation. The electric resistance test evaluates a material's ability to resist the flow of electric current. The results reveal that an increase in aluminum content leads to decreased temperature and heat generation due to aluminum's higher thermal conductivity compared to brass. As a consequence, bimetals with higher aluminum content experience less deformation under the same load. The analysis is crucial for optimizing the design of bimetallic components for various applications. ANSYS Workbench proves to lead a correct study, offering detailed investigation of the bimetal's behavior under different conditions. The findings provide a proper knowledge of the bimetal's performance, showcasing the significance of finite element analysis in engineering and design processes.

Key Words: Bimetal, Ansys, Finite Element Analysis, Simulation, Electric Resistance.

1. Introduction

The comprehension of material behavior and its distinct properties became possible with the advent of quantum mechanics in the 1930s. Quantum mechanics provided an atomistic understanding, explaining the behavior of atoms and solids. This knowledge formed the foundation of Materials Science, which combines physics, chemistry, and a focus on the relationship between material properties and microstructure. Throughout history, materials processing by hand has been a fundamental practice of civilization.

Comment [UoK1]: use past tense
what are variables to be studied?
what are the specific(%) and significant findings?

Comment [UoK2]: general discussions!

Comment [UoK3]: Not a keyword

However, with the Industrial Revolution in the 18th century, mechanization ushered in a new era. The study of flow of liquid metals into molds is crucial. Fluidity, which pertains to the flow properties of liquid metals and their interaction with mold materials, plays a pivotal role in successful casting. However, understanding fluidity is challenging due to the complexity of the flow process, particularly the additional factor of temperature drop during the flow. Measurement of fluidity often occurs after the solidification of the liquid metal, necessitating consideration of the phase transformation from liquid to solid. Despite its importance in foundry practices, a comprehensive understanding of fluidity and its comparative values requires further research [12].

Comment [UoK4]: extensive general discussions

The system under consideration involves a solidifying casting with the casting mold, environment, and external influences. During the filling of the mold cavity, heat transfer occurs between the metal surface and the mold walls through conduction and convection. This process generates a pseudo-initial temperature field in the volume of the casting and mold, which significantly affects the mold cavity filling and subsequent cooling and solidification of the casting. Therefore, the rate of heat transfer also plays a crucial role in determining the properties of the cast. Bimetals consist of two different metals layered together and others such as cast surfacing, continuous casting, centrifugal casting, and more. In this study, an Al-Cu bimetal is considered, which is manufactured by joining the interface with a very thin layer of welding, negligible in size. The manufacturing process of the bimetal is based on the principle of centrifugal force applied to a rotating component, as illustrated in Figure 1. The molten metal is discharged into a rotating mold, and the centrifugal force caused by the rotation forces the metal towards the outer wall of the mold. The mold continues to rotate until the entire casting solidifies. Lighter components like slag oxide and other inclusions separate from the metal and gather towards the center. As a result, the metal is forced from the central axis of the equipment into individual mold cavities positioned on the circumference. This process increases the filling pressure within each mold and allows for the replication of intricate details [13, 14].

Comment [UoK5]: extensive general discussions!

Various molding methods are adapted to this centrifugal casting process, and the unit costs of centrifuged castings depend largely on the type of mold used.

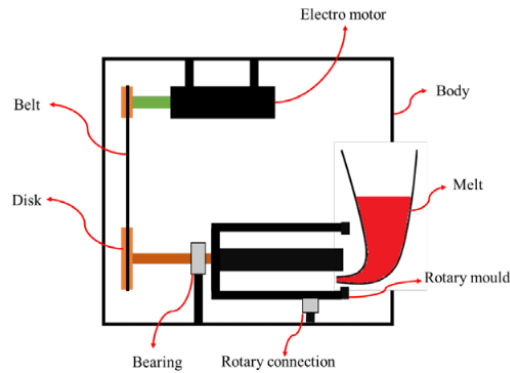

Figure. 1 Centrifugal Casting Process

Comment [UoK6]: ref.?

Comment [UoK7]: what were the significant and specific(%) findings for the previous studies?

Casting is a prominent manufacturing process, and numerous researchers have focused on bimetall casting to address issues and enhance product quality. Several studies in this field have demonstrated variations in the quality of cast products. Naoya Hirataet et al [1] have explored the influence of mold rotation speed, center offset, and gravitational force on flow patterns and cooling curves, summarized by dimensionless Froude number. The calculation time was discussed, highlighting the high efficiency of the particle method's parallelization. Petru Ungur et al [2] study showed that high HFC (High-Frequency Current) for bimetallic steel-bronze bushes ensures good adherence of bronze on steel support and minimizes steel case cracks during cooling. Madhusudhan et al [3] observed cooling rates of the liquids at various rotational speeds, affecting the solidification rate of centrifugal casting. Similar behaviors were observed in microstructures of centrifugally cast Al-12 Si castings. C. G. Kang et al [4] analyzed the particle segregation model and found that the thickness of the region with segregated particles is influenced by mold rotation speed, solidification time, and density difference between the base alloy and reinforcement. Keerthi et al [5] found that grain size and mechanical properties vary with mold rotational speed. Kestur Sadashivaiah Keerthiprasad et al [6] studied the effect of process variables on flow patterns and observed reasonable agreement between numerical simulation and cold modeling experiments.

Madhusudhan et al [7] have measured grain size for gravity castings at different cooling rates and determined the rate of solidification for centrifugal castings produced at various rotational speeds. M. Cholewa et al [8] presented the technology of bimetallic layer casting, assessing the quality of castings through ultrasonic non-destructive testing, structure examination, and hardness evaluation. J. Nazari et al [9] produced Copper-Aluminum bimetal through centrifugal casting and evaluated the Copper-Aluminum interface and solidification time. Sivakumar et al [10] have compared bimetal compositions of Copper-Stainless Steel and Stainless Steel-Aluminum using ANSYS. Shatrudhan Pandey et al [11] analyzed bimetal produced by centrifugal casting with an Aluminum-Copper interface, studying defects formed due to faulty casting methodology and proposing proper casting techniques for successful metallurgical bonding in bimetals.

Comment [UoK8]: what is the gap in knowledge to be covered in the present study?

2. Simulation Study – Ansys

ANSYS Workbench, developed by ANSYS Inc. USA, is a sophisticated Computer-Aided Finite Element Modelling and Finite Element Analysis tool. Its Graphical User Interface (GUI) enables users to create 3-dimensional (3D) models and perform Finite Element Analysis (FEA) simulations. The software is capable of conducting a wide range of tasks, from design assessments to complete product optimization analyses. ANSYS Workbench allows for the integration of stand-alone analyses into projects, streamlining project workflows. The tool is specifically designed to handle complex simulations involving Multiphysics coupling, making it suitable for conducting comprehensive studies and integrated simulations. It boasts versatility in performing various types of analyses, including structural, thermal, fluid, and electromagnetic analyses. The project at hand is structured into three distinct phases: Electric, Thermal, and Structural. Each phase is executed sequentially to ensure a systematic approach. The electrical module's output serves as input for the thermal module, and the corresponding results are then fed into the structural module to obtain the desired outcome of the bimetal's mechanical displacement. This step-by-step process ensures a well-coordinated analysis of the

bimetal's behavior under different conditions, facilitating a deeper understanding of its performance characteristics.

2.1 Generating a Model

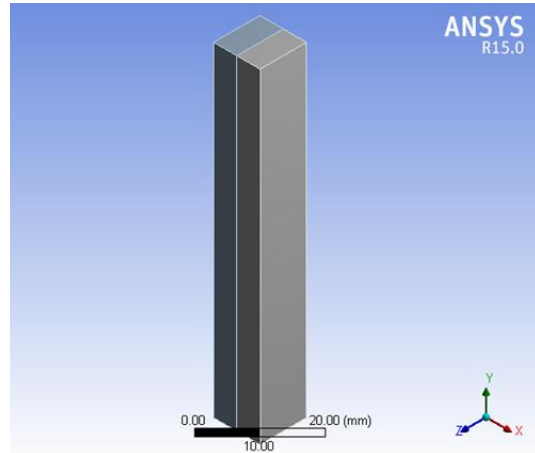

Figure 2: 3D Model of Bimetal

Preprocessing is shown in the Figure 2: 3D Model of Bimetal, known as model preparation, constitutes the initial phase of Finite Element Analysis. This crucial step involves defining the material properties of the model through the Engineering data module. Here, material properties can be tailored to match real-time environmental conditions. The modeling of the bimetal is achieved using design modeler, which is specifically designed to furnish geometry that aligns with the user's requirements. The geometry can be easily created and modified to suit the analysis environment. In Table 1, we present the material properties of the bimetal for reference.

Table 1: Material Properties of a bimetal

Sl. No.	Parameters	Materials	
		Aluminum alloy	Brass
1	Density	2.77e-006 kg mm ⁻³	8.3e-006 kg mm ⁻³
2	Young's Modulus (MPa)	71000	1.1e+005
3	Poisson's Ratio	0.33	0.34
4	Bulk Modulus (MPa)	69608	1.1458e+005
5	Shear modulus (MPa)	26692	41045
6	Specific Heat	8.75e+005 mJ kg ⁻¹ C ⁻¹	3.85e+005 mJ kg ⁻¹ C ⁻¹

Comment [UoK10]: All elements types (with details) and material models should be indicated. Specimens to be studied should be indicated.

Comment [UoK11]: tested?

7	Coefficient of Thermal Expansion	2.3e-005 C ⁻¹	1.8e-005 C ⁻¹
---	----------------------------------	--------------------------	--------------------------

2.2 Meshing

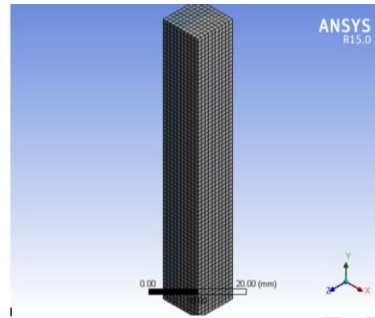

Figure 3: 3D Meshed Model of Bimetal

Meshing is shown in the figure 3, involves discretizing a continuous body into a finite number of elements. Increasing the number of elements generally improves the accuracy of the results; however, it also leads to longer processing times for the entire analysis. The most common approach is to allow the meshing to be generated automatically, although it can be more or less controlled by the user. In this step, a fine mesh is generated for the model. The geometry is divided into 33,954 nodes, which represent coordinate locations in space where degrees of freedom (DOFs) are defined. Additionally, 6,800 elements are generated to represent the geometry accurately. The analysis employs the global coordinate system, which defines nodes across the entire body.

Comment [UoK12]: Quality of fig. is not adequate

Comment [UoK13]: Nothing is clear!

Comment [UoK14]: general discussions!

2.3 Boundary Conditions

The following Boundary Conditions have been taken to carry out the analysis in an electric module.

Table 2: Bimetal Boundary Conditions

SI. No.	Particulars	Values
1	Initial Temperature	22°C
2	Current	4, 8, 16 and 32A
3	Time	Unit time
4	Convection	All Faces of the component

The bimetal is subjected to a different range of current (1 – 32A) for a unit time at the face having higher thermal coefficient of expansion.

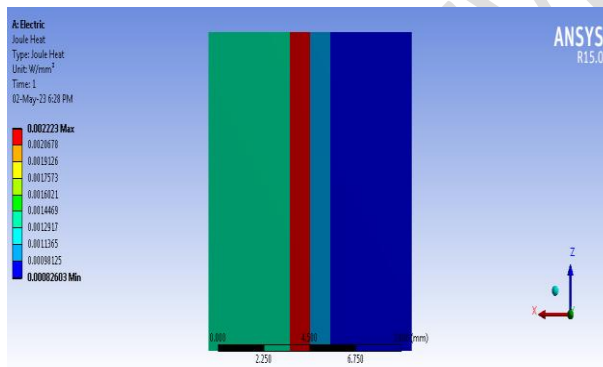

Figure 4: Current to the Bimetal

Comment [UoK15]: fig. is not clear

To facilitate the conversion of electrical current is shown in Figure 4 & table 2, the into heat energy, the utilization of Joule heating is imperative. Joule heating is a phenomenon wherein the passage of current through an electrical conductor results in the production of thermal energy, commonly known as heat. In the case of the Aluminium-Brass combination, Joule heating is directly correlated to the flow of current. The output or solution obtained from module 1, which is the electric module, serves as the input for module 2 in the analysis. This sequential approach allows for the proper integration of the electrical analysis results into the subsequent stages of the analysis.

Comment [UoK16]: check

2.4 Transient Thermal

Transient thermal analysis involves studying how a system reacts to both constant and changing boundary conditions over time. When dealing with fixed boundary conditions, one can assess the time it takes for the system to reach a steady state temperature and how long it can sustain operational conditions before reaching a critical temperature. On the other hand, for time-varying boundary conditions, transient analysis reveals the system's thermal response to these variations. This type of analysis is particularly useful for understanding the system's behavior during transitions between different operating conditions before it returns to a steady state. In the analysis of the bimetal, uniform convection was assumed on all surfaces, and the initial temperature of the component was set at 22 °C. When this fluid motion is primarily driven by density variations due to temperature gradients, it is termed "Natural Convection." This natural convection process occurs uniformly on the bimetal's surfaces, especially when thermal stresses are induced on the component under different levels of electric current.

Comment [UoK17]: extensive general discussions!

2.5 Thermal Load

Total heat load can be found using the following formula, $Q = AU\Delta t$

Q - Total Heat Load

A - Area

U - Coefficient of heat Conductivity

Δt - Difference in temperature

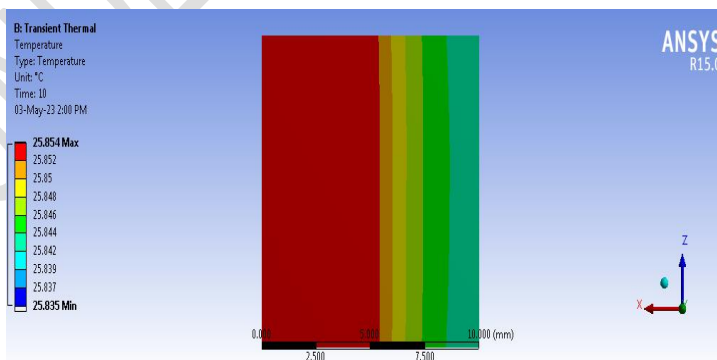

Figure 5: Temperature Distribution on Bimetal

Comment [UoK18]: Quality is not adequate

Based on the Figure.5 depicting the temperature distribution on the bimetal (composed of copper and stainless steel), it was observed that at 32A of electric current and for a unit time, the maximum temperature reached in the bimetal is 25.854°C, while the minimum temperature on the lower surface was 22.02°C. The flow of current through the component leads to Joule heating in the bimetal, causing the temperature variations observed. The obtained thermal load result can be utilized as an input for the Transient Structural module, allowing for the evaluation of the component's deflection at different levels of electric current. This analysis enables a comprehensive understanding of how the bimetal behaves and responds to varying thermal conditions, which is crucial for optimizing its design and performance in real-world applications.

Comment [UoK19]: re-write

2.6 Thermo-Structural Analysis

Comment [UoK20]: verification study is necessary

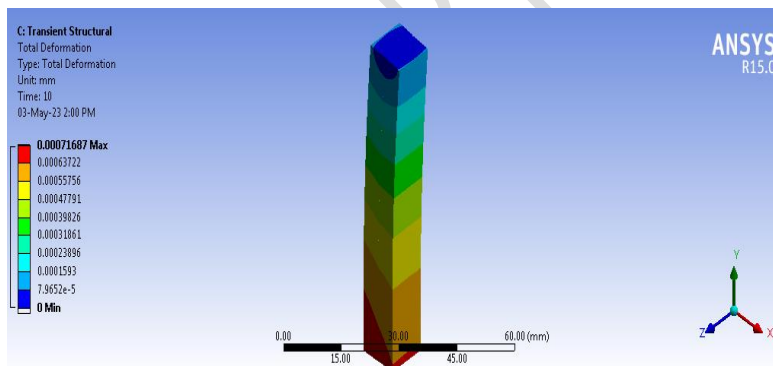

Figure 6: Thermo-Structural Analysis Result

Comment [UoK21]: Quality is not clear

Based on the figure 6, it was observed that the maximum deflection in the bimetal occurs at the tip due to the increase in temperature caused by the flow of electric current. This deflection reaches a value of 7.16×10^{-4} mm when a current of 32A flows for a unit of time, triggering the cutoff switch to break the circuit and stop the operation. The study also revealed that the structural deformation is directly related to both the temperature and the current flowing through the bimetal. For the Aluminium-Brass

combination, the maximum temperature recorded was 25.854°C, and the resulting deflection measured 7.16e-4mm. This variation in deflection is primarily influenced by the differences in thermal conductivity, coefficient of thermal expansion, density, and specific heat between Aluminium and Brass. Due to its heavier weight compared to Aluminium, Brass requires stronger structures and hardware to support its use. However, Brass is more ductile and possesses high tensile strength. On the other hand, while Aluminium has good conductivity and low resistivity, it is higher in cost than Brass. Additionally, compared to Brass, Aluminium is lighter and more cost-effective but exhibits lower conductivity and higher resistivity due to the possibility of oxide surface formation, leading to heating.

Figures 7 to 10 illustrate the results of the thermo-electric analysis conducted on the Al-Br bimetal for different electric current levels: 32A, 16A, 8A, and 4A. These findings contribute to a deeper understanding of the bimetal's behavior under varying conditions and can aid in optimizing its design and applications.

Comment [UoK22]: Quality is not adequate

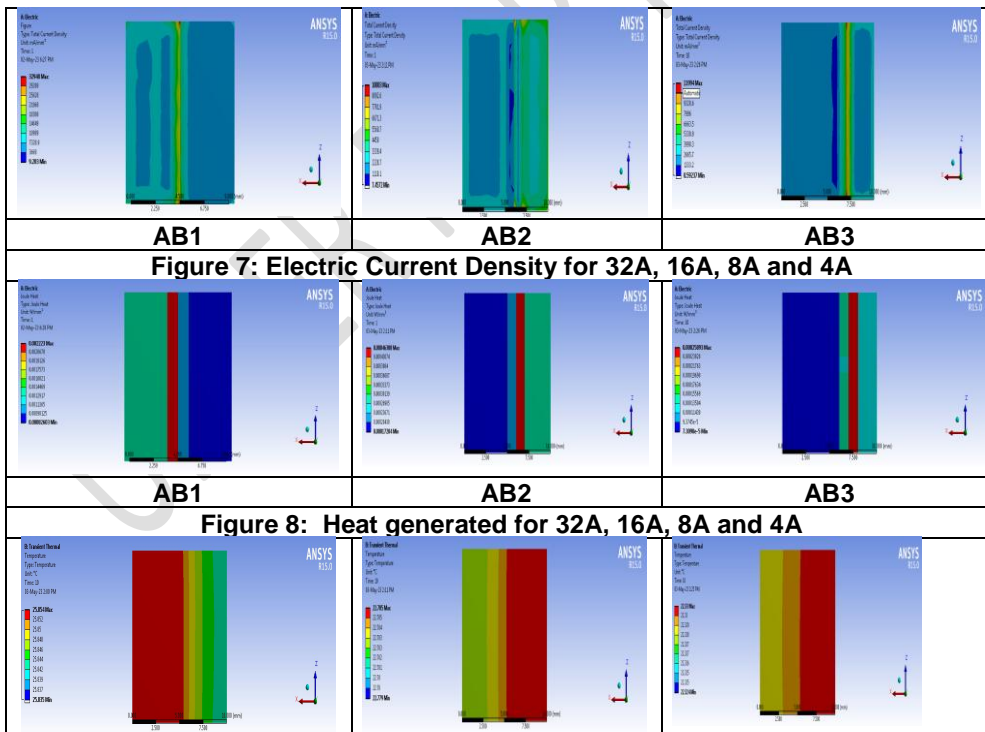

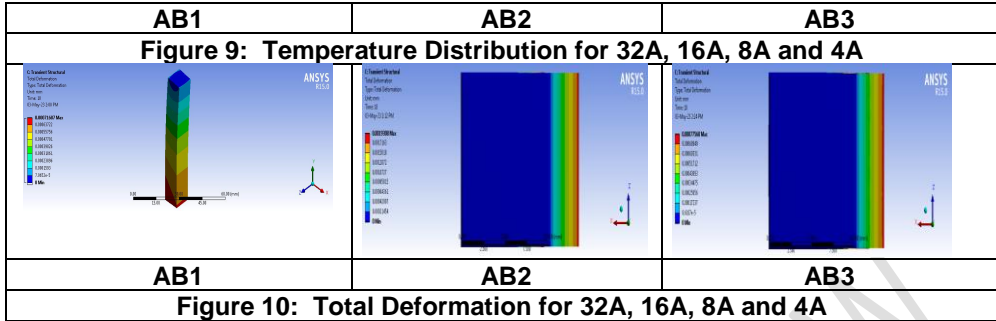

2.7 Variation of Temperature vs Current in Bimetal

Table 3: Current vs Temperature in Bimetal

Current(A)	Maximum Temperature		
	AB1	AB2	AB3
32	25.854	24.785	24.33
16	22.436	22.268	22.104
8	22.009	23.092	22.02
4	22.002	22.493	22.05

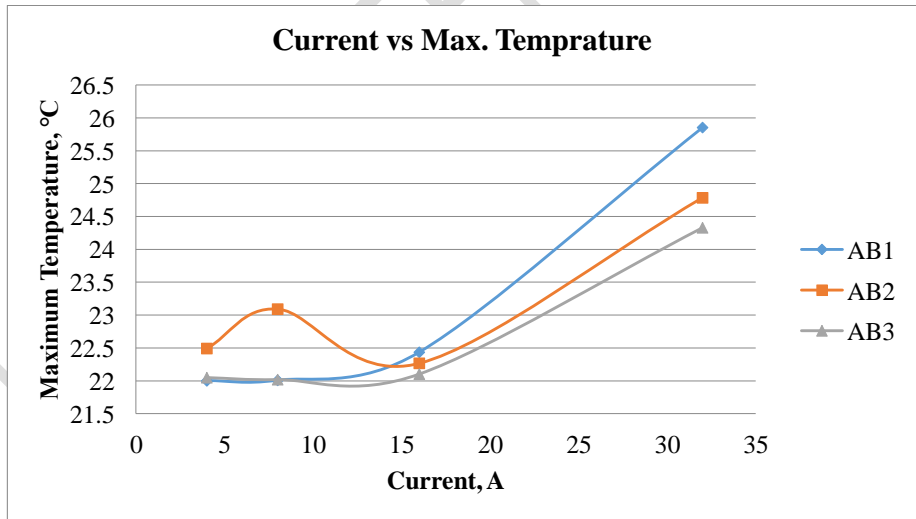

Figure 11: Graph of Current vs Temperature for Different Al-Br Bimetal

From figure 11 & table 3, the graph clearly depicts a noticeable trend: as the current level increases, the maximum temperature of the specimens also increases. This phenomenon can be attributed to the direct relationship between the current level and the amount of electrical energy dissipated in the specimens. As more electrical energy is dissipated, a larger amount of heat is generated in the specimens. Moreover, the variations in the maximum temperature values among different specimens indicate that the material composition of each specimen plays a crucial role in its ability to conduct and dissipate heat. The differences in thermal conductivity and other material properties contribute to the varying heat dissipation capabilities observed in the specimens. In general, aluminum exhibits higher thermal conductivity compared to brass, enabling it to conduct heat more efficiently and dissipate it at a faster rate. Consequently, this characteristic leads to lower maximum temperatures in aluminum compared to brass.

2.8 Variation of Deformation vs Current in Bimetal

Table 4: Variation of Deformation vs Current in Bimetal

Current(A)	Deformation		
	AB1	AB2	AB3
32	0.000716	0.00193	0.000776
16	0.0007483	0.000661	0.000245
8	1.33E-05	0.002601	4.37E-06
4	3.05E-06	0.001174	1.20E-05

Comment [UoK23]: Deflection?

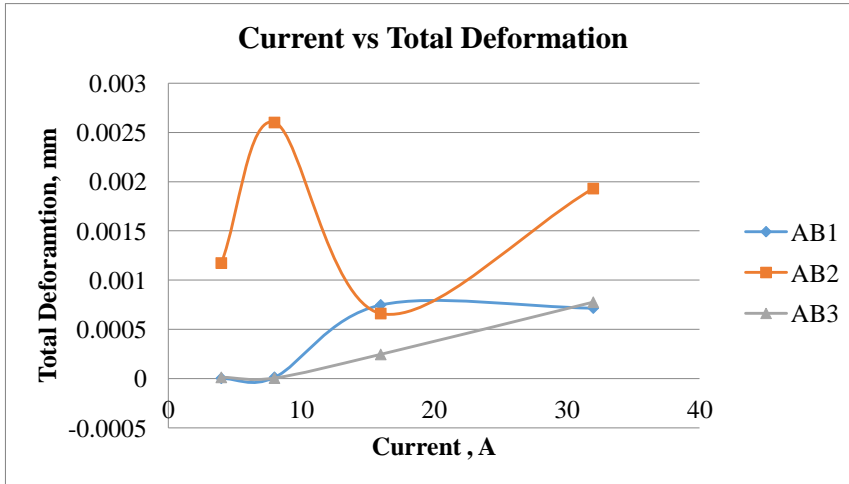

Figure 12: Graph of Deformation vs Current for Different Al-Br Bimetal

Comment [UoK24]: detail of AB1, AB2 and AB3?

According to the graph as shown in the figure 12 % table 4, it is evident that the deformation of the specimens tends to rise with an increase in the current level. This can be attributed to the direct correlation between the current level and the extent of deformation. When the composition of aluminum and brass is equal, the specimens demonstrate moderate deformation ability. However, as the aluminum composition increases, the deformation ability also increases, mainly due to aluminum's superior ductility compared to brass. Therefore, an equal mixture of brass and aluminum appears to be more favorable in terms of deformation compared to the other compositions.

2.9 Variation of Heat Generated vs Current in Bimetal

Table 5: Variation of Heat Generated vs Current in Bimetal

Current(A)	Heat Generated		
	AB1	AB2	AB3
32	0.00262	0.00243	0.001944
16	0.000247	0.000148	7.60E-05
8	8.21E-06	0.001045	1.55E-05
4	1.87E-06	0.000472	4.09E-06

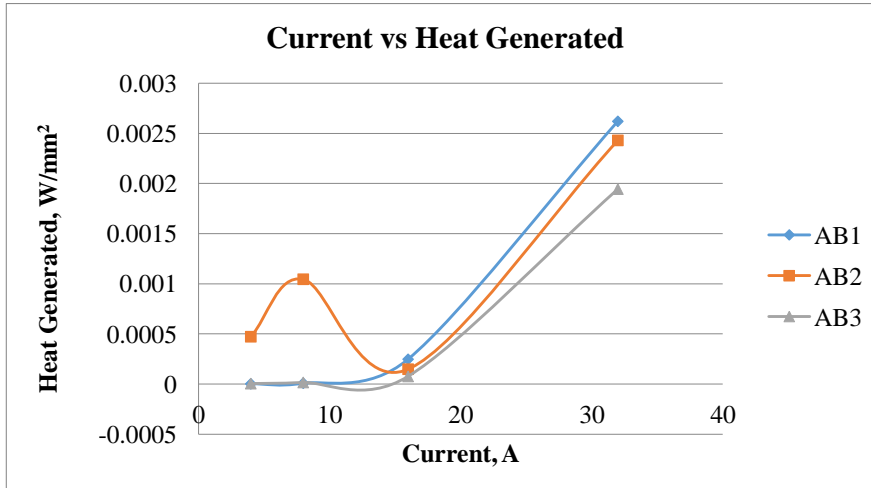

Figure 13: Graph of Heat Generation vs Current for Different Al-Br Bimetal

From the figure 13 & Table 5, The temperature of an equal composition of brass and aluminum may not necessarily be higher compared to other specimens. The heat generation and temperature depend on various factors, including the specific composition and processing methods used for each material, as well as the specific conditions of the application.

Regarding the electrical conductivity of aluminum and brass, it is true that aluminum generally exhibits higher electrical conductivity than brass, enabling it to transfer electricity more efficiently. However, electrical conductivity is not directly related to heat generation, which relies on factors such as resistance, current, and the thermal properties of the material. In terms of heat generation, it is generally true that a higher composition of aluminum with brass can result in less heat generation compared to a higher composition of brass, primarily due to aluminum's higher heat conductivity. This property allows aluminum to transfer heat away from the source more effectively, leading to lower heat generation. Nevertheless, it's essential to acknowledge that the specific properties of each alloy can vary, and other factors, such as the particular application and operating conditions, can also impact heat generation.

3. Results and Discussions

Comment [UoK25]: what are the previous discussions to be called.then?

Electric resistance test using the finite element analysis (FEA) method is applied on the bimetallic materials that are composed of two different metals, and they can exhibit unique properties that are not present in either of the individual metals alone. In this case, a bimetal with aluminum and brass was generated by centrifugal casting using different compositions of the two metals used for simulation study. The electric resistance test measures the ability of a material to resist the flow of electric current. The results showed that an increase in aluminum content led to a decrease in temperature and heat generated. This is because aluminum has a higher thermal conductivity than brass, which means it can dissipate heat more efficiently. As a result, the bimetal with higher aluminum content experienced less deformation under the same load.

Conclusion

In conclusion, the study utilized ANSYS Workbench, a powerful Computer-Aided Finite Element Modelling and Analysis tool, to perform a comprehensive analysis of a bimetal composed of aluminum and brass. The analysis was divided into three phases: electric, thermal, and structural, allowing for a sequential evaluation of the bimetal's behavior under different conditions. During the modeling phase, the material properties of the bimetal were defined, and a 3D model was generated using the graphical user interface of ANSYS Workbench. Meshing, or discretization of the model into finite elements, was performed to obtain accurate results while considering the computational cost. In the electric module, Joule heating was employed to convert electrical current into heat energy, and the resulting thermal load was then fed into the transient thermal module. The transient thermal analysis evaluated how the bimetal responded to varying boundary conditions over time, and it was observed that the maximum temperature and thermal deformation increased with higher current levels.

The thermal load results obtained were further utilized in the transient structural module to assess the deflection of the bimetal at various electric current levels. The thermo-structural analysis revealed that the maximum deflection occurred at the tip of the

Comment [UoK26]: Brief, Specific (%) and significant conclusions should be presented.

bimetal due to increased temperature, and a correlation was established between structural deformation and the flow of electric current. Additionally, the study investigated the variation of temperature, deformation, and heat generation concerning the electric current levels in the bimetal. It was observed that an increase in aluminum content led to lower maximum temperatures and heat generation, attributed to aluminum's higher thermal conductivity. The analysis provided valuable insights into the behavior of the bimetal and highlighted the importance of material composition and thermal properties in determining its performance. These findings can be instrumental in the design and optimization of bimetallic components for various applications. ANSYS Workbench proved to be an indispensable tool in conducting this comprehensive study, enabling a detailed analysis of the bimetal's response to various conditions. The results obtained contribute to a better understanding of the bimetal's behavior and its potential applications in real-world scenarios, demonstrating the significance of finite element analysis in engineering and design processes.

References

[1] Naoya Hirata, Koichi Anzai, Numerical analysis of centrifugal separation behavior during centrifugal casting using particle method, In: Tetsu-To-Hagane/Journal of the Iron and Steel Institute of Japan, Vol. 103, No. 12, 2017, p. 771-779.

[2] Pop, PA, Ungur, P, Lopez Martinez, J, & Bejinaru-Mihoc, G. "Theoretical and Practical Estimations Regarding of Borderline Conditions Imposed for Qualitative Achievement of Sliding Bimetallic Bearings from Steel-Bronze." Proceedings of the ASME 2009 International Manufacturing Science and Engineering Conference. ASME 2009 International Manufacturing Science and Engineering Conference, Volume 1. West Lafayette, Indiana, USA. October 4–7, 2009. pp. 569-576. ASME. <https://doi.org/10.1115/MSEC2009-84193>.

[3] Madhusudan Senapati , Sampada K. Parida, Bharat K. Swain, Gouranga C. Dash, MHD Free Convective Flow in a Composite Medium Between Co-axial Vertical Cylinders with Temperature Dependent Heat Flux on Inner Cylinder, Mathematical

Comment [UoK27]: check style of citation!

Comment [UoK28]: check ref.!

Modelling of Engineering Problems, Vol. 7, No. 3, September, 2020, pp. 476-482, Corresponding, <https://doi.org/10.18280/mmep.070319>.

[4] Y.H. Seo, C.G. Kang, Micromechanical solidification heat transfer and initial strain estimation in the fabrication process of particles-reinforced aluminum composites, Journal of Materials Processing Technology, Volume 72, Issue 1,1997, Pages 152-161, ISSN 0924-0136, [https://doi.org/10.1016/S0924-0136\(97\)00146-5](https://doi.org/10.1016/S0924-0136(97)00146-5).

[5] Prasad, K.S. Keerthi, P.G. Mukunda, S.C. Sharma, and M.S. Murali. "Analysis of centrifugal casting using tin." International Journal of Applied Engineering Research 4, no. 2 (2009).

[6] Madhusudhan, P G Mukunda, S Narendranath, G C Mohan Kumar, Effect of Mould Wall Temperature on Rate of Solidification of Centrifugal Casting, International Journal of Advanced Materials Science, Vol 4, No 1 (2013), Pages: 37-42, Published: 2013-08-09.

[7] M. Cholewa, T. Wróbel S. Tenerowicz, Bimetallic layer castings, Journal of Achievements of Materials and Manufacturing Engineering, November 2010.

[8] Nazari, J., et al. "Production of Copper-Aluminum Bimetal by Using Centrifugal Casting and Evaluation of Metal Interface." International Journal of Materials Lifetime 1.1 (2015): 20-28.

[9] Nazari, J. , Yousefi, M. , Kerahroodi, M. A. , Mofrad, N. B. , & Abhari, S. A. (2015). Production of Copper-Aluminum Bimetal by Using Centrifugal Casting and Evaluation of Metal Interface. International Journal of Materials Lifetime, 1(1), 20-28.

[10] R K Jaya Kumar, T Ashokkumar and P Sivakumar, Comparative analysis of deflection in a bimetal, ICIRMCT 2021, IOP Conf. Series: Materials Science and Engineering 1091 (2021) 012070, IOP Publishing doi:10.1088/1757-899X/1091/1/012070.

[11] Shatrudhan Pandey, Mesra Sanjay Kumar Jha Purushottam Kumar, Ankush Kumar Bharat, Analysis of Defects for Aluminium Copper Bimetal Fabricated By Centrifugal Casting, ELK Asia Pacific Journals – 978-93-85537-06-6, ARIMPIE -2017.

[12] Hirata, N., Yeni, M. Z., & Anzai, K. (2013). Fluid flow and heat transfer simulation of centrifugal casting using particle method. Tetsu-To-Hagane/Journal of the Iron and steel Institute of Japan, 99(2), 97 104. <https://doi.org/10.2355/tetsutohagane.99.167>

[13] Manufacturing process and applications of composite materials ANNALS OF THE ORADEA UNIVERSITY Fascicle of Management and Technological Engineering jan 2010.

[14] Experimental Study on Cooling Rate of Centrifugal Casting Based on Grain Size, International Journal of Scientific & Engineering Research, Volume3, Issue1, January-2012 , ISSN 2229-551.

UNDER PEER REVIEW