

## **Original Research Article**

# **Analysis and research of compound refrigeration based on logic control battery**

---

### **ABSTRACT**

At present, the world consumes too much non-renewable energy such as oil and natural gas, which directly leads to two major problems: energy crisis and environmental pollution. In order to deal with the dual challenges of energy crisis and environmental pollution, new energy vehicles enter people's life as an effective solution. Lithium-ion battery has become the first choice for power batteries due to its high energy density and many advantages. Lithium-ion battery is the core component of electric vehicle. If the heat generated by lithium-ion battery cannot be dissipated in time when it is working, it may cause thermal runaway due to its high temperature or large temperature difference, leading to fire or explosion. Therefore, in order to seek reliable cold source for effective thermal management in high temperature environment, ensure the stable operation of new energy vehicles and prevent thermal safety problems, it is extremely important to design a thermal management system with excellent performance.

Firstly, a battery model based on logic control and lumped heat parameters was established to determine the real-time and accurate state of battery heat generation, heat transfer, radiation heat dissipation and battery temperature. The model parameters were obtained by experiments considering the effects of charging and discharging rate, cooling motor power and temperature, and the established model was verified. Secondly, the battery air cooling, liquid cooling and heat management system is established, and combining the air cooling and liquid cooling, a new inverse mixed cooling method is proposed, and the mixed cooling model is built. By changing the wind speed and flow rate, the cooling effect of air cooling and liquid cooling is analyzed with the change of medium flow rate. The results show that, in a certain range, the greater the flow rate, the more obvious the cooling effect of the cooling method, and the flow rate is positively correlated with the cooling effect. In order to compare the cooling effect of the new inverse cooling system, the temperature rise curves and temperature difference curves of different cooling methods and energy consumption were analyzed under the different discharge rates of 4C and 8C respectively. The results show that under the three cooling methods, according to the logic control, the energy consumption analysis of the equilibrium process, when the system tends to be stable, the total energy consumption of liquid cooling and opposite mixing refrigeration is basically the same, and the energy consumption of air cooling is the largest. According to the analysis of the maximum equilibrium temperature difference inside the battery cell when the thermal management reaches stability, the temperature difference of the cooling mode of the opposite direction mixing refrigeration is the minimum, about 1°C. According to the analysis of the fluctuation range when the battery pack temperature is stable, the hybrid refrigeration has the minimum fluctuation, only 2°C.

In conclusion, the power battery hybrid cooling method based on logic control has good cooling performance in power battery thermal management. It provides a new solution and design idea for lithium ion battery thermal management

*Key words: logic control; Mixed refrigeration; Battery thermal management; Cooling effect;*

# 1. INTRODUCTION

## 1.1 Research background and significance

The atmosphere is the life basis of people's life happiness, is the fundamental guarantee of life, everything in the world depends on the atmosphere to survive. With the continuous development and improvement of human production level, environmental pollution is triggered when the impact of people's activities on the environment has exceeded its self-purification ability. All kinds of air pollution show the worsening of climate change year by year, for example: The greenhouse effect, the destruction of the ozone layer, acid rain and so on, the pollution of the atmosphere not only affects the sustainable development, but also affects the physical and mental health of everyone.

In recent years, due to the rapid development of industrial modernization and the increasing of national living and consumption capacity, the number of vehicles in China has been increasing year by year. The core pollution source has been transformed from coal for living and industrial production to coal for living, industrial production, vehicle emission and construction dust. Among them, vehicle emissions account for a large proportion, and hydrocarbon, particulate matter, nitrogen oxide and other emissions tend to increase year by year [1]. By the end of June 2022, the number of motor vehicles in China has reached 417 million, including 319 million automobiles, according to the Annual Report on Environmental Management of China Mobile (2022) released by the Ministry of Ecology and Environment. According to the annual data of 2021 released by China Automobile Association, China's automobile production and sales in 2021 were 26.275 million and 26.082 million respectively, with year-on-year growth of 3.8% and 3.4%. The production and sales of new energy vehicles in China reached 3.545 million and 3.521 million respectively, breaking through 3.5 million for the first time. Accounting for 13.40% and 13.59% of automobile production and sales, with year-on-year growth of 59.2%. The production and sales of pure electric vehicles were 2.942 million and 2.916 million, respectively; The e production and sales of plug-in hybrid electric vehicles were 601,000 and 603,000, respectively. In 2021, the emissions of carbon monoxide (CO), hydrocarbons (HC), nitrogen oxides (NO<sub>x</sub>) and particulate matter (PM) from motor vehicles in China will be 7.683 million tons, 2.04 million tons, 5.821 million tons and 69,000 tons respectively, with a year-on-year decrease of 7.06% in NO<sub>x</sub> and a year-on-year increase of 5.36% in HC [2].

The pure electric vehicle industry is moving steadily towards the direction of industrialization, but it is also facing a series of technical problems, such as battery life, motor transmission efficiency, vehicle control and thermal management [3]. Based on the current development stage, the battery life problem is difficult to be completely solved in a short time, so it is necessary to find other effective scientific methods to make the battery play its role as much as possible under the condition of limited power reserve. Through repeated tests and data analysis, researchers learned that the performance of batteries is particularly affected by temperature [4]. Lithium iron phosphate battery is widely used in electric vehicles. In order to give full play to its highest performance and ensure the optimal charging and discharging efficiency, it should be maintained within 16~40°C. Batteries exposed to high temperatures for a long period of time will suffer from reduced life and increased risk, and their performance will also be affected. Among them, whether the working environment of battery pack is safe or not is the key point that must be paid attention to whether it can be used in electric vehicles [5]. In order to improve the performance of power battery, it is necessary to conduct reasonable thermal management. According to battery performance requirements, the thermal management of batteries should meet the following three requirements:

### (1) Thermal safety

In order to meet the energy demand of high capacity and high voltage with the energy storage device used by electric vehicles, a single lithium-ion battery is usually connected in series or parallel in the form of battery module or battery pack. Excessive accumulation of individual

batteries in a limited space will cause serious heat generation in the center of battery modules or battery packs. If the heat dissipation is not timely, electrolyte decomposition, electrochemical harmful gas accumulation, battery explosion and other phenomena may occur [6].

## (2) Thermal uniformity

Lithium-ion batteries are often made into cylinders or cuboids according to the use needs of real situations. The anisotropic thermal conductivity of different shapes often has a difference of tens of times, which leads to a large temperature difference inside a single battery. At the same time, in the battery pack, battery pack and other forms, due to the different heat dissipation conditions and ways, often lead to high temperature in the middle, low around the phenomenon, with the continuous accumulation of heat, will aggravate the temperature of the whole battery pack or battery pack uneven. According to the "barrel principle", the single battery with the worst performance will affect the performance of the whole battery pack, and further affect the capacity, impedance and health status of the battery pack [7-9].

## (3) Thermal reliability

Lithium ion batteries need the best operating temperature, because the best operating temperature can give full play to the electrochemical performance of lithium ion batteries and prolong the cycle life of lithium ion batteries. At excessively high working temperature, the cycle life of lithium ion batteries will be significantly shortened, the effective capacity will be significantly attenuated, and the electrochemical performance of lithium ion batteries will be seriously decreased [10].

### **1.2 Research status at home and abroad**

To keep the lithium-ion battery within the safe operating temperature range, ensure the temperature uniformity inside the battery pack, and avoid accidents such as thermal runaway caused by excessive temperature, you need to take appropriate thermal management measures for the lithium-ion battery. At present, a variety of thermal management implementation schemes have been put into practical application. For example, Toyota adopts forced air cooling for thermal management and Tesla adopts liquid cooling for thermal management [11]. Scholars at home and abroad have studied various schemes and achieved remarkable results, mainly focusing on air cooling and liquid cooling.

For the air cooling technology of power battery, the structure arrangement of air cooling, the design way of runner and the distance between cells are very important to the heat dissipation effect of battery pack. Many scholars have proposed new designs based on the existing structures. When analyzing the thermal characteristics of power lithium battery and studying the air-cooled structure of battery pack, Chu Guangxin proposed the air-cooled heat dissipation method of adding filter plate, studied the influence of the free area ratio of three parts of filter plate on the air-cooled heat dissipation effect, and obtained the best free area ratio combination of 0.3, 0.9 and 0.9. The influence of wind speed, battery spacing, number of air outlet and battery bottom spacing on air cooling heat dissipation effect was studied by single factor analysis method, and the optimal combination of the best heat dissipation effect was obtained [12]. Zhang et al. designed an air-cooled T-type battery thermal management system (T-BTMS) based on the traditional U-type and Z-type in order to solve the problems of high battery temperature and poor uniformity during high-intensity operation. The temperature and airflow distribution of T-cell thermal management system were simulated based on the validated CFD method. Compared with Z-type and U-type, T-type battery thermal management system is more effective in improving cooling performance and has lower power consumption [13]. Ren et al. developed a new type of active air cooling TMS based on U-shaped micro-heat pipe array, and established three modes of heat dissipation module with or without U-shaped MHPA for comparative experiments. The results show that the maximum instantaneous temperature of U-shaped MHPA active air cooling and non-U-shaped MHPA passive air cooling are 51.70 °C and 57.83 °C respectively under 2C constant current charging and 3 C constant current discharge conditions [14]. Xu Xiaoming analyzed the flow paths of forced air cooling systems of different battery packs based on the

coupling relationship between velocity field and heat flow field in synergy principle. Based on four different working conditions, the forced air cooling performance of double "U" type duct and double "I" type duct is simulated. According to the result analysis, the heat dissipation effect of double "U" shaped duct on battery pack is better than that of double "I" shaped duct [15]. Li Kangjing et al. studied the thermal management of lithium-ion power battery packs for air-cooled vehicles, and used CFD software to explore the effects of battery arrangement, battery spacing and air inlet wind speed on the temperature field distribution of battery packs. The results show that when the battery is discharged at 2 C, the sequential arrangement is the most beneficial to the heat dissipation of the battery pack. Reducing the battery spacing can restrain the maximum temperature of the battery pack, and the optimal temperature uniformity of the battery pack is 4mm[16]. Kai Chen et al. used the flow resistance network model to calculate the airflow velocity in the cooling channel and designed the spacing distribution of battery packs in parallel air-cooled BTMS to improve the cooling efficiency of the system. The results show that the cooling efficiency of BTMS is obviously improved by optimizing the cell spacing. Compared with the original BTMS, optimized BTMS battery pack, the highest temperature decreased 4.0 K in the biggest battery temperature difference under different inlet flow rate was reduced by 69% or more [17].

The design of inlet and outlet in the air cooling and heat management scheme is the research focus in recent years. By optimizing the inlet and outlet, the cooling performance of the air cooling and heat management system can be further improved. Feng Shitong analyzed the thermal management system and structure optimization of the air-cooled power battery pack and obtained the structure size of the box with the best heat dissipation effect by optimizing the analysis of the box body. The methods of adding air intakes at side and front positions of the battery case are compared comprehensively. The results show that when four intakes with two angles of 45° and two angles of 90° are set on the side, the battery pack not only meets the requirements of the normal operating temperature of the battery, but also consumes less energy, and the cooling efficiency of the battery cooling system is the best [18]. From the perspective of structural design, Xiao Han discussed the influence of four different rectangular straight rib structures and different return duct structures on the convective heat transfer performance of the power battery system. The results show that reducing the width of the return duct is beneficial to improve the uniformity of the air volume of each outlet of the main duct, and it can also rationally arrange the deflector or increase the cross-sectional area of the outlet where the air volume is small, so as to effectively increase the air volume. On the contrary, the wedge-shaped return duct structure is not suitable for this power battery system [19]. In order to improve cooling efficiency and optimize the structure of U-flow parallel air-cooled battery thermal management system, Kai Chen et al. adopted nested ring method and numerical calculation method to optimize the Angle and width of air intake and air outlet. The calculation results show that the cooling efficiency of BTMS can be significantly improved by optimizing the width of air inlet and outlet [20].

A large number of scholars have studied the application and performance of liquid cooling technology in battery pack cooling, among which some achievements have been made in the branch channel of liquid cooling plate, the connection mode of battery and the arrangement of liquid cooling pipeline. In order to solve the thermal safety problem of a lithium iron phosphate power battery, Zhang Lin designed a liquid cooled battery thermal management system based on the flow resist-thermal resistance network model to optimize the heat dissipation performance and energy consumption of the liquid cooled battery thermal management system. Then, the influences of the number of branch channels and channel layout on the total thermal resistance and pressure loss of the liquid-cooled plate were studied. The research shows that when the branch channels are 6 and the channels are arranged longitudinally, the heat dissipation performance and system energy consumption are better [21]. Sheng et al. proposed a numerical study on the thermal management of lithium-ion batteries with double inlet and outlet by using a snake-like channel liquid cooled plate heat exchanger. The results show that the location of the inlet and outlet and the flow direction have a great influence on the temperature distribution of the battery and the power consumption ratio of the cooling plate. Increasing the fluid flow significantly reduces the maximum temperature rise of the battery module, but has little effect on the temperature distribution. In addition, the channel width of the cooling plate has a great influence

on its power consumption ratio and the temperature distribution of the battery, but has little influence on the maximum temperature rise of the battery [22]. Yi Mengfei et al. designed a U-shaped battery thermal management system based on composite cooling for a commercial prismatic lithium iron phosphate battery. Through experimental research, numerical simulation and optimization design, the thermal performance of the U-shaped battery complex thermal management system under different conditions was studied and analyzed. The results show that U-shaped air-liquid composite refrigeration can ensure thermal uniformity and ensure normal operation of batteries at different discharge rates [23].

## **2. POWER BATTERY SPECIFICATION AND THERMAL CHARACTERISTIC PARAMETER SELECTION**

### **2.1 Power battery analysis and selection**

Lithium battery is a kind of energy storage element with lithium metal or lithium ion as electrode material. According to the cell is mainly divided into cylindrical lithium battery, square lithium battery and soft pack lithium battery. Square lithium battery has high energy density and large capacity, but the individual difference is large, and the system life is lower than that of single battery. Soft pack lithium battery has small internal resistance, good cycle performance and high specific energy, but high processing cost, low degree of production automation, production obstacles. Columnar lithium battery has the advantages of good consistency, good mechanical properties, mature technology, low cost, small energy and high controllability. According to the positive electrode material, it can be divided into lithium metal battery and lithium ion battery. Lithium metal battery generally uses manganese dioxide as the negative electrode material, lithium metal as the negative electrode material and non-aqueous electrolyte solution, but it belongs to the primary energy battery. Lithium-ion batteries generally use lithium combined metal oxide as the positive electrode material, graphite as the negative electrode material. Lithium-ion battery has become the first choice for power battery because of its superior performance. Lithium ion power battery is a new type of high energy battery with lithium iron phosphate, lithium cobalt oxide and lithium titanate as the positive electrode and graphite as the negative electrode. In the process of use, lithium ions are repeatedly unembedded, and the material utilization rate is high, so compared with other batteries, this kind of battery has better charge-discharge cycle performance. It has the advantages of light weight, no memory, high energy density, high voltage, wide operating temperature range, low self-discharge rate, long storage life and so on. At present, the most popular cylindrical battery in automotive power lithium batteries are 18650 and 21700.

At present, the related technology of 18650 battery, which is widely used in electric vehicles, has been mature. However, with the increase of social demand, fast charging, structural simplification and reliability of electric vehicles have become new breakthrough directions. In this case, the 21700 lithium battery operation and up. As shown in Table 1 below, 18650 and 2170 lithium batteries differ significantly in size, energy density, cost, capacity and performance. It is mainly introduced in four aspects:

(1) Increase the battery capacity by 35%. Take the 21700 battery produced by Tesla as an example. After switching from model 18650 to model 21700, the capacity of each battery can reach 3 to 4.8Ah, a significant increase of 35%.

(2) The energy density of the battery system is increased by about 20%. According to the data disclosed by Tesla, the energy density of 18650 battery system used in the early stage is about 250Wh/kg, and the energy density of 21700 battery system produced later is about 300Wh/kg. The volume energy density of 21700 battery is nearly 20% higher than that of the original 18650.

(3) The cost of the system is expected to decrease by about 9%. According to the battery price information disclosed by Tesla, the 21700 battery's power lithium battery system sells for \$170 /Wh, while the 18650 battery system sells for \$185 /Wh. With 21700 batteries in the Model3, the battery system cost alone can be reduced by about 9%.

(4) The weight of the system is expected to decrease by about 10%. The overall volume of the 21700 is larger than that of the 18650 unit. As the capacity of the unit increases, the energy density of the unit increases. Therefore, the number of batteries required for the same energy can be reduced by about 1/3. When Samsung SDI switched to a new 21700 battery, it found that the system weighed 10% less than the current battery.

To sum up, the 21700 battery not only maintains the high reliability and stable performance of the 18650 battery, but also improves significantly compared with the 18650 battery in all aspects.

**Table 1. Different columnar lithium battery parameter table**

battery model	Size (mm)	As the voltage (v)	Charging voltage (v)	Monomer battery capacity (mAh)	The energy density (Wh/kg)
18650	18*65	2.0-2.5	4.2	1200-3600	250
21700	21*70	2.5-2.75	4.2	3000-4800	300

When the battery pack has the same amount of power, the number of individual batteries in the battery pack will be greatly reduced, which reduces the complexity of the battery pack structure. The smaller number of batteries also reduces the difficulty of monitoring BMS; Replacing 18650 cells with 21700 cells does not reduce the porosity of the cell block, so the volume of the cell pack and the number of cooling structures are the same. In this paper, LS 21700 lithium iron phosphate battery is selected as the research object, and its relevant electrochemical parameters are shown in Table 2. To prepare for the establishment of heat generation model of single lithium battery in the following chapter.

**Table 2. Detailed parameters of 21700 lithium iron phosphate battery**

Parameter	Value
type of battery	LR21700LA battery
measure	21.7±0.2mm×90.9±0.2mm
nominal voltage	3.65v
Maximum charging voltage	4.2v
end-off voltage	2.75v
battery capacity	4000mAh
anode material	LiFe [(PO)] <sub>4</sub>
mass	68g
impedance	≤12mΩ

## 2.2 Thermal characteristics of power batteries

### 2.2.1 Heat generation mechanism of lithium ion battery

The internal structure and heat generation mechanism of lithium batteries are relatively complex. In engineering, according to different sources and electrochemical analysis of lithium ion batteries, heat generation of lithium batteries is often simplified into four parts, which are the main chemical reaction heat  $Q_r$ 、 exothermic auxiliary reaction  $Q_s$ 、 heat of polarization reaction、 heat of polarization reaction  $Q_p$  and Joule heat  $Q_j$ , reach :

$$Q = Q_r + Q_s + Q_p + Q_j \#(1)$$

(1) Chemical reaction heat( $Q_r$ ) :

In the process of REDOX reaction, the heat generated in order to maintain the conservation of energy in the process of lithium ion movement is mainly generated at the positive electrode, the contact part between the negative electrode and the electrolyte, and the contact part between the negative electrode and the adhesive. In addition, heat is absorbed or released in the process of charging and discharging respectively, and the corresponding positive and negative values are taken. The calculation formula is as follows:

$$Q_r = \frac{nmQ_{pn}I}{MF} \#(2)$$

Where: n represents the number of battery cells; m represents positive and negative electrode mass (g);  $Q_{pn}$  said is negative to produce heat and heat the algebraic sum of (KJ/mol); I represents discharge current (A); M is the molar mass (g/mol); F is Faraday's constant, 96,484.5 C per mole.

(2) Deputy heat of reaction ( $Q_s$ ) :

the excess charge and discharge batteries, battery temperature to produce side effects under the condition of high quantity of heat, normal use, the battery can be ignored.

(3) Polarization reaction heat ( $Q_p$ ) :

lithium-ion batteries in charging and discharging process of charging and discharging current, SOC, environment temperature, battery materials, etc., on the electrode surface to produce polarization makes the voltage difference is formed between the open circuit voltage and the terminal voltage, the resulting heat production called polarization reaction heat. The calculation formula of polarization reaction heat is:

$$Q_p = I^2 R_p \#(3)$$

Where: I is the charging and discharging current, unit (A);  $R_p$  is the battery polarization resistance, unit  $\Omega$ .

(4) The joule heat ( $Q_j$ ) :

the joule heat is lithium ion battery in the normal work of the main sources of heat, when the current through these materials can produce joule heat, the calculating formula for the charging and discharging, the battery of electric current through the battery of irreversible heat resulting from the inherent resistance, its expression is as follows:

$$Q_j = I^2 R_j \#(4)$$

Where: I is the current size, unit (A);  $R_j$  is the ohm internal resistance of the battery, in  $\Omega$ .

### 2.2.2 Heat generation model of lithium ion battery

It is the basis of research to construct reasonable heat generation model of lithium ion battery. In theory, the heat generation rate of lithium-ion battery can be obtained by actual measurement, but the actual measurement is often difficult due to the variety of materials and complex structure of lithium-ion battery. Many scholars have made corresponding research on solving the heat generation rate of lithium ion batteries, and continue to simplify the heat generation model of lithium ion batteries. According to Bernardi's simplified model, the heat generation rate is used to approximate the temperature characteristics of charge and discharge of lithium ion, which is used as the heat generation model for thermal management of lithium ion batteries. The formula is as follows:

$$Q = I(E - U) + IT \frac{dE}{dT} \#(5)$$

$$q = \frac{Q}{V} \#(6)$$

Type:  $q$  is lithium ion battery unit volume heat production rate, unit  $w/m^3$ ;  $\frac{dE}{dT}$  is the temperature entropy coefficient, and the value is  $0.4mv/k$ .  $E$  is battery electromotive force, unit  $v$ ;  $U$  is the operating voltage of the battery (unit:  $v$ ).  $V$  is the cell volume,  $m^3$ .

Where, when the battery is in a normal working environment and the side reactions are basically negligible, the ohmic internal resistance and polarization internal resistance are replaced by equivalent internal resistance  $R$ , then the formula of heat generation rate per unit volume of lithium battery can be expressed as:

$$q = \frac{I[IR - T\frac{dE}{dT}]}{V} \#(7)$$

#### (1) Thermal conductivity of lithium battery in different directions

Due to the different material composition in different directions, the radial thermal conductivity, axial and circumferential thermal conductivity of cylindrical lithium-ion batteries are also different. Ignoring the contact internal resistance of each layer, the radial thermal conductivity of the battery can be regarded as the series axial and circumferential thermal conductivity of each layer and the parallel connection of each layer. The radial and axial thermal conductivity of the battery are:

$$\lambda_1 = \frac{\sum_{i=1}^n L_i}{\sum_{i=1}^n \frac{L_i}{K_i}} \#(8)$$

$$\lambda_2 = \frac{\sum_{i=1}^n A_i K_i}{\sum_{i=1}^n A_i} \#(9)$$

Where:  $\lambda_1$  is the radial thermal conductivity of the battery,  $w/(m \cdot k)$ ;  $\lambda_2$  is the axial and circumferential thermal conductivity of the battery,  $w/(m \cdot k)$ ;  $L$  is the thickness of each layer of battery material (unit:  $m$ );  $K$  is the thermal conductivity of each layer,  $w/(m \cdot k)$ ;  $A$  is corresponding to the direction of heat transfer on the flat area, unit  $m^2$ .

#### (2) Density and specific heat capacity of lithium battery

Similarly, the weighted average method is used to predict the density and specific heat capacity of lithium batteries. The calculation expression is as follows:

$$\rho = \frac{\sum_{i=1}^n m_i}{\sum_{i=1}^n v_i} = \frac{\sum_{i=1}^n \rho_i v_i}{\sum_{i=1}^n v_i} \#(10)$$

$$c = \frac{1}{m_c} \sum_{i=1}^n c_i m_i \#(11)$$

Type:  $\rho$  the average density of lithium-ion batteries ( $kg/m^3$ );  $m_i$  the mass of each component of the battery ( $kg$ );  $v_i$  the battery of the volume of each component ( $m^3$ );  $\rho_i$  the density of the components of the battery ( $kg/m^3$ );  $c$  the average specific heat capacity of lithium battery  $J/(kg \cdot K)$ ;  $c_i$  specific heat capacity of battery components ( $J/(kg \cdot K)$ ).

The axial and radial thermal conductivity of 18650 lithium iron phosphate battery are  $21.1 w/(m \cdot k)$  and  $0.89 w/(m \cdot k)$ , respectively. The average specific heat capacity and density were  $1135.2J/(kg \cdot K)$  and  $2722 kg/m^3$ , respectively.

### 3. POWER BATTERY TEST CALIBRATION

In the process of battery discharge, the battery will inevitably generate heat because of the ohmic resistance, but also the heat generated by the internal electrochemical reaction, especially in the

high power discharge, the battery will have obvious temperature rise; Battery temperature changes have a significant impact on battery performance. Both high and low temperature will seriously affect battery performance and even safe use of batteries. In order to study the thermal properties of battery cells, this section tests the temperature rise of battery discharge at different charging and discharging rates and at different ambient temperatures. In order to carry out testing work, it is necessary to build an experimental platform and conduct experimental operations according to the test steps to obtain the test results of the monomer, and verify the accuracy of the simulation model by comparing the experimental results of temperature rise with the simulation results.

### **3.1 Thermal characteristic experiment of single power battery**

The battery is first connected to the temperature tester using a temperature sensor, and the battery is placed on the battery test system. Then the battery test system is placed in the high and low temperature experiment box, and connected with the computer, so that the computer can monitor the status of the battery in real time. The specific parameters and limiting conditions of each step are set through the supporting software on the computer, such as constant current discharge, constant current charging, static, circulation, etc. Finally, by adjusting the setting of the high and low temperature experiment box, the temperature in the experiment box reaches a certain value, in order to simulate the environmental temperature in the process of charge and discharge.



**Figure 1. Temperature rise test device of single battery**

### **3.2 Simulation of single thermal characteristics of power battery**

As shown in figure 2, according to table 2, the detailed parameters of 21700 lithium iron phosphate batteries, using Amesim platform structures, 21700 monomer battery simulation model, the model will be divided into two parts, respectively is the system module and thermal battery monomer module, control of battery charge ratio, Simulate the thermal characteristics of battery cells under certain conditions.

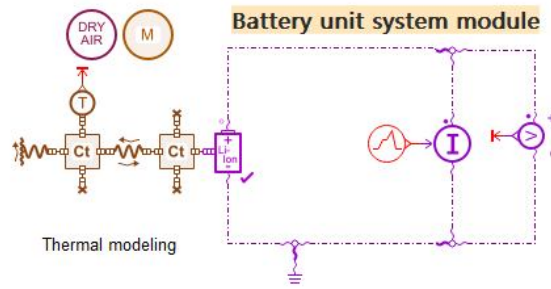
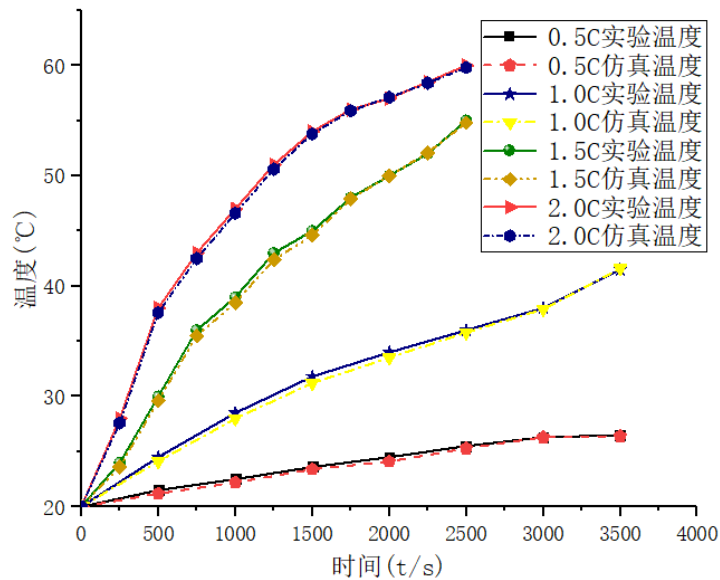

Figure 2. Simulation model of a single battery

### 3.3 Experimental measurement results of single battery thermal characteristics

In order to verify the accuracy of the simulation results, the simulation data under the three ambient temperatures were compared with the experimental data of battery temperature rise, as shown in Figure 3. It can be found that under three ambient temperatures and three discharge rates, the temperature size and variation trend of the battery obtained by simulation are very close to the experimental results, and the temperature rise curves of simulation and experiment are basically consistent. It can be seen that under the three ambient temperatures, the maximum error of the battery is less than  $1^{\circ}\text{C}$ , the root mean square error is less than  $0.3^{\circ}\text{C}$ , and the error accuracy is less than 5%. Combined with the simulation and experimental results, the analysis errors are mainly caused by three parts: first, the simulation model is a simplified model, so there is a certain range of model errors between the built model and the actual parts; Secondly, although the experimental environment controls constant temperature, constant pressure and humidity, there may still be some operating errors. Moreover, when selecting parameters, the convective heat transfer coefficient is set to a fixed value. In fact, the convective heat transfer coefficient of the battery and the external environment is positively correlated with the battery temperature. By combining experimental results with simulation results, the model can meet the requirements of simulation calculation.



(a) Temperature comparison between simulation and experimental batteries at different discharge rates at  $20^{\circ}\text{C}$

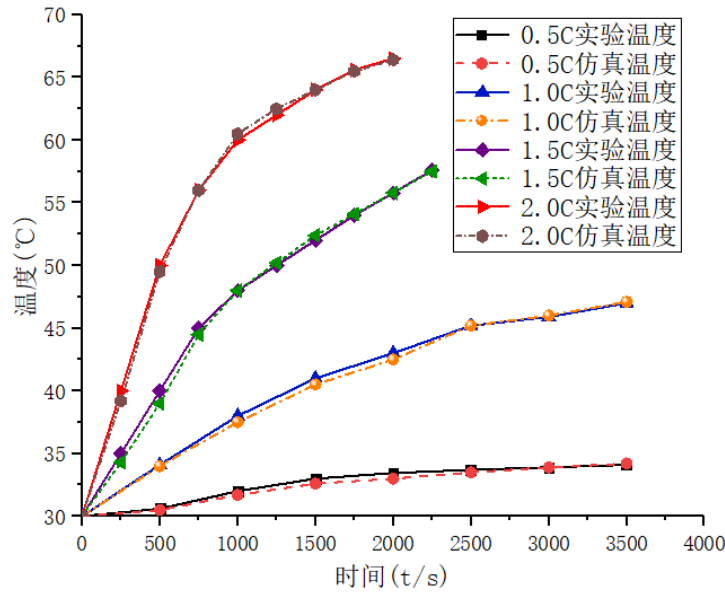

(b) Comparison of temperature between simulated and experimental batteries at different discharge rates at 30°C

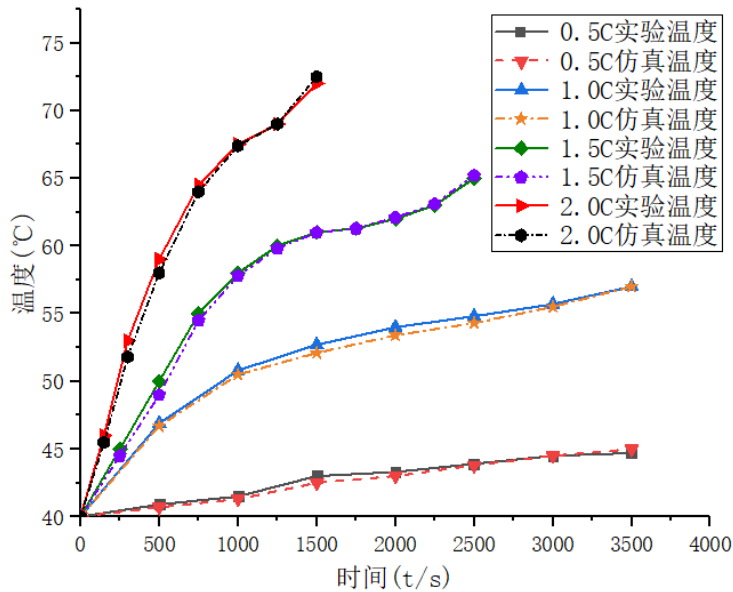

(c) Temperature comparison between simulation and experimental batteries at different discharge rates at 40°C

Figure 3. Temperature rise curve of single battery experiment and simulation

## 4. BUILD THE POWER BATTERY THERMAL MANAGEMENT SYSTEM

### 4.1 Establishment of thermal management system for power battery model

In the battery design of new energy electric vehicles, the panels are often arranged by hundreds of single batteries. When these batteries work at the same time, the temperature of the whole

battery module will rise sharply. In order to ensure the safety of electric vehicle in the process of driving, the problem of heat dissipation of battery module composed of many battery units in panel design is solved. This section will analyze the two common ways of battery thermal management, combining the two ways of air cooling and liquid cooling, put forward a new directional composite refrigeration system, research and analysis.

In the thermal management system, the main structure includes: fan, flow equalizing plate, cooling tube, lithium ion battery pack, partition board, porous wall, etc. The active cooling adopts the combination of direct liquid cooling and air cooling, in which the forced air cooling relies on the fan at the front of the cooling box for forced cooling. After the fan is opened, the air flow is dispersed through the flow equalizing plate, evenly passes through the lithium-ion battery pack, and finally flows out of the cooling box through the porous wall at the rear end. The liquid cooling system mainly relies on the external pump body to transport the coolant to the box through the coolant inlet pipe. The coolant flows through the whole battery pack and then flows out of the box through the coolant outlet pipe. In the liquid cooling solution, the coolant is a mixture of water and glycol. 3 mm and 4 mm space are left at the lower and upper ends of each battery. The liquid cooling and air cooling bidirectional thermal management system can effectively reduce the maximum temperature and temperature difference of the battery string and improve the heat dissipation performance. There are eight batteries in a row. The distance between the center of the two rows of batteries is 20 mm. The outside of the single-row battery cooling structure is provided with a fireproof sealing partition to prevent the spread of the battery after thermal runaway and the large area of coolant leakage. The distance between the outer wall of the single-row cooling structure and the partition is 2 mm. Battery parameters are as follows: Voltage, capacity, and size of the 18650 lithium-ion battery.

#### **4.1.1 Construction of air cooling model**

Air cooling refers to air cooling, which means that air enters the battery module and takes away the battery heat by convection heat transfer between the battery surface and the air to achieve cooling effect. Air cooling is the earliest and simplest thermal management technology for lithium ion batteries. According to whether air flows spontaneously, air cooling is generally divided into active air cooling and passive air cooling. Passive air cooling takes advantage of natural convection of air in the driving process to cool lithium-ion batteries. Active air cooling forces external air into the lithium-ion battery pack for convection heat transfer through certain components, and can control temperature and flow. In terms of cooling effect, active air cooling is better than passive air cooling. Thermal management systems that use air convection to control heat mainly use air as the heat transfer medium. Local radiators or fans are installed around the battery module. Some can also use additional or built-in evaporators to provide cold air. Air cooling is divided into parallel ventilation and serial ventilation depending on the way the external airflow passes through the battery module.

As shown in Figure 4. In this paper, the method of parallel ventilation and heat dissipation is selected. The air flow is divided into six parts by the heat dissipation fan, which passes through the module successively along the arrangement direction of the battery, and finally gathers in the tail pipe to discharge. Figure 4 is mainly divided into two modules: battery cooling system and logical control motor and cooling fan. The control mechanism of logic control is as follows: when the ambient temperature is 20°C, the internal temperature of the battery gradually rises with the process of battery charging and discharging. When the temperature reaches 20+2°C, the motor works with the minimum power set. When the temperature reaches 35°C, the motor starts to work with the highest power set; Ensure that the battery operates within a safe and reliable temperature range.

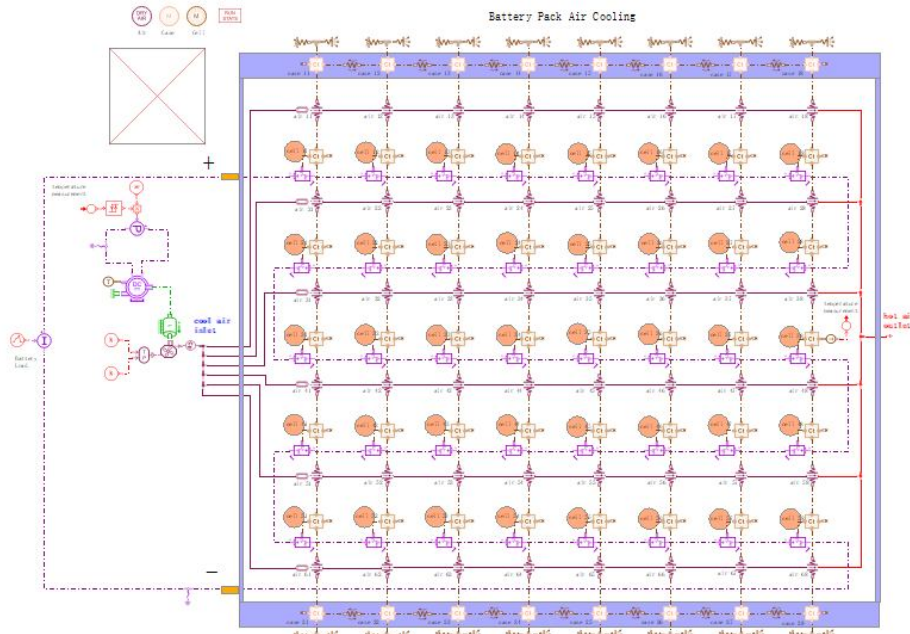
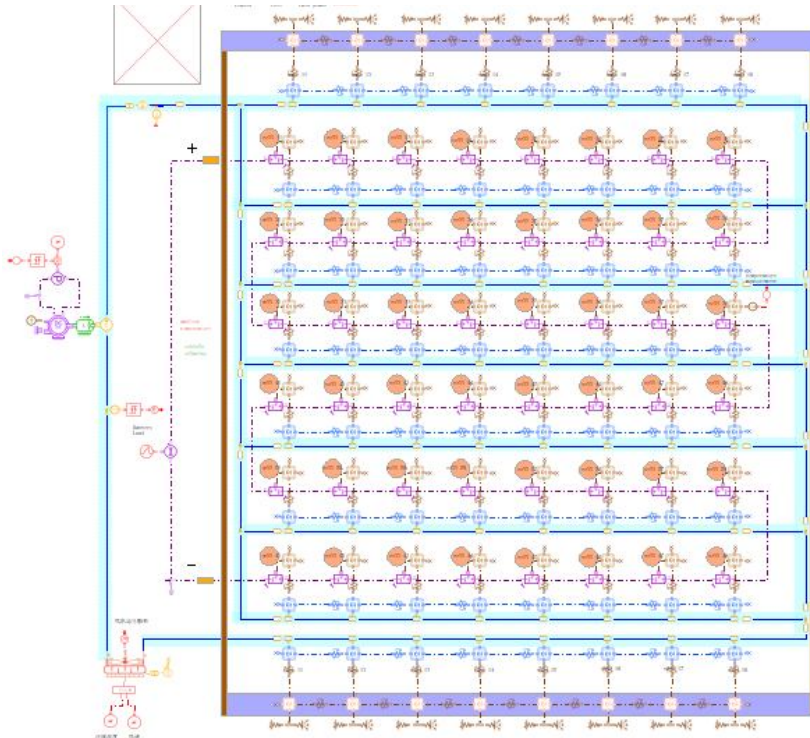

Figure 4. shows the battery air-cooled refrigeration model based on logic control

#### 4.1.2 Construction of liquid cooling model

The liquid-cooled power battery cooling system uses special coolant to flow in the coolant pipeline inside the power battery to transfer the heat generated by the power battery to the coolant, so as to reduce the temperature of the power battery. It is suitable for complex operating condition of automobile and high discharge rate of battery. Liquid cooling is an effective cooling method due to its high thermal conductivity and specific heat capacity. Liquid cooling system has been the main thermal management cooling scheme in the field of new energy vehicles, and has achieved good results. Generally, the battery thermal management system based on liquid cooling has a high heat transfer coefficient, and can be divided into direct contact and indirect contact according to whether the battery surface is in direct contact with the heat transfer fluid.

As shown in Figure 5, this paper adopts the method of parallel liquid cooling with unilateral inlet and outlet. The coolant is driven by the water pump and divided into six parts through the trunk pipe, which pass through the module successively along the arrangement direction of the battery and finally converge in the tail pipe and merge, then flows through the cooling system and the cooling fan dissipates the coolant, and then flows to the water pump to continue cooling the battery pack. The figure is mainly divided into two modules: battery cooling system and logical control motor and cooling fan. The control mechanism of fuzzy control is as follows: when the ambient temperature is  $20^{\circ}\text{C}$ , the internal temperature of the battery gradually rises with the process of battery charging and discharging. When the temperature reaches  $20+2^{\circ}\text{C}$ , the motor works with the minimum power set. When the temperature reaches  $35^{\circ}\text{C}$ , the motor starts to work with the highest power set; Ensure that the battery operates within a safe and reliable temperature range.

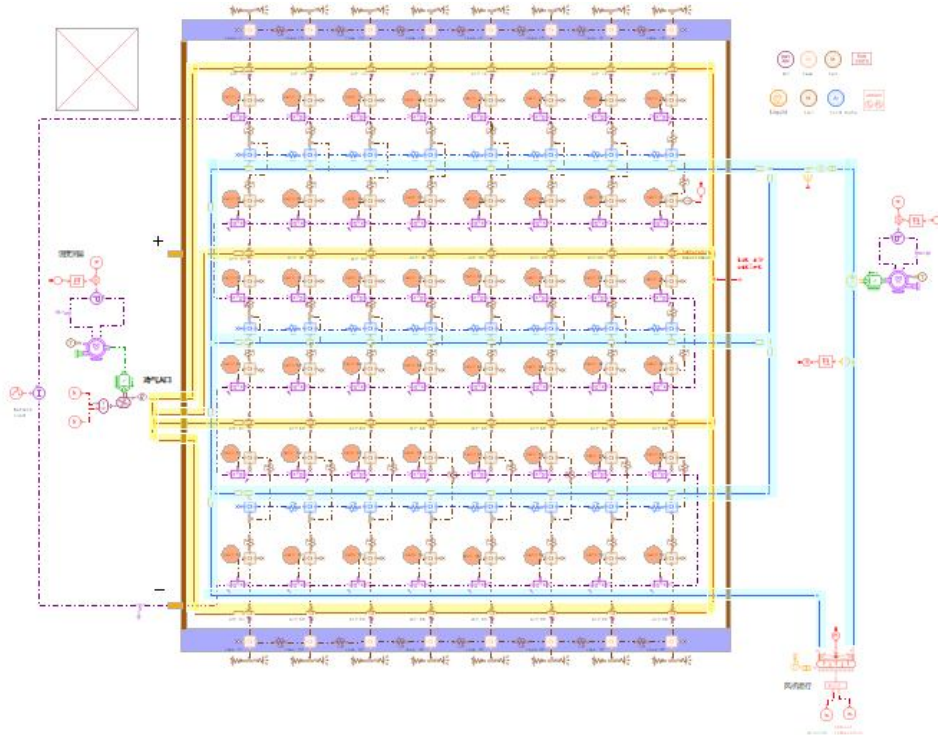

**Figure 5. shows the battery liquid cooling and heat management model based on logical control**

#### **4.1.3 Construction of bidirectional composite refrigeration system**

With the continuous development of new energy vehicles, to cope with various environmental challenges, the working conditions of power batteries are becoming more and more complex, which leads to the continuous increase of lithium-ion battery capacity and energy density, which requires the thermal management design of lithium-ion batteries must keep pace with The Times. When a single battery or battery pack works at high temperature and high rate discharge, higher heat accumulation will be generated. The single lithium-ion battery thermal management solution used in the past is no longer able to meet the increasingly stringent demand for lithium-ion battery heat dissipation. In order to achieve the goal of lithium-ion battery heat dissipation, designers at the present stage begin to adopt two or even multiple composite cooling methods, such as phase change material-air-cooled composite, phase change material-liquid-cooled composite, indirect liquid-cooled composite, heat-pipe air-cooled composite and so on. In this paper, a new cooling mode of indirect liquid cooling and air cooling convection cooling is adopted, and logical control is used to reasonably cooperate with liquid cooling and air cooling mode to achieve optimal thermal management of power batteries.

Figure 6 is mainly divided into three parts: battery structure, air cooling system, liquid cooling system. Battery structure design, using 6x8 arrangement combination, each row of batteries on both sides of the air-cooled and liquid-cooled cooling pipes, pipes using parallel two-way convection, air-cooled cooling gas from the left side into, right outflow collection, liquid cooling liquid from the right into, through the battery heat dissipation, outflow from the left summary, recycling. The design of the air cooling system adopts the logical control of the driving fan to the system heat management, the control system is divided into two stages, respectively corresponding to different motor power. Liquid cooling system design also adopts fuzzy control, divided into two control modules, water pump control module and cooling fan control module, both of which are second-order control.



**Figure 6. shows the thermal management model of battery opposite-direction composite refrigeration based on logic control**

## **5. ANALYSIS OF BATTERY REFRIGERATION SYSTEM**

### **5.1 Analysis of wind cooling effect of power battery based on logic control**

#### **5.1.1 Relationship between air cooling effect and air velocity**

As shown in Figure 7, the air flow rate of the power battery was  $v=2\text{m/s}$ ,  $2.5\text{m/s}$ ,  $3.0\text{m/s}$ ,  $3.5\text{m/s}$ ,  $4.4\text{m/s}$ ,  $4.5\text{m/s}$ ,  $5.5\text{m/s}$ , and  $0.0\text{m/s}$ , respectively, and the temperature of the battery changed with time. The same logic control principle is used. When the battery temperature rises to the logical control opening temperature ( $22^{\circ}\text{C}$ ), the system adopts very low wind speed for the battery thermal management, and the battery temperature rises slowly. When the battery temperature rises to the logical control maximum temperature ( $35^{\circ}\text{C}$ ), the system adopts the set wind speed to cool the battery system, and the battery temperature begins to decline and tends to be stable. According to the battery temperature rise curves at different wind speeds in the figure, the cooling effect is positively correlated with the wind speed. The higher the wind speed is, the better the cooling effect will be. However, as the wind speed increases, the influence of the wind speed on the cooling effect gradually decreases.

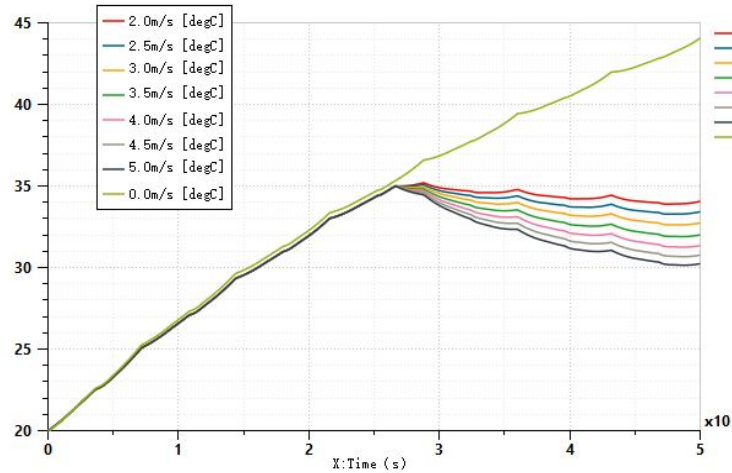

Figure 7. shows the temperature curve of power battery under different wind speeds

### 5.1.2 Relationship between liquid cooling effect and mass flow rate

As shown in Figure 8, when the mass flow rate of the cooling medium was 0.06kg/s, 0.08kg/s and 0.10kg/s respectively, the liquid cooling temperature curve changed over time. As can be seen from the figure, under the three kinds of mass flow rates, the temperature of the battery fluctuates up and down within the temperature range of fuzzy control. When the temperature reaches 22°C, the first stage of logical control will be started, and the liquid cooling will be started, running at the lowest power and the temperature rising slowly. When the temperature reaches 35°C, the second stage of logical control will be started, and the cooling system will run at the highest power. The temperature of the battery begins to drop sharply to 22 °C Celsius and it runs on low power, and so on. According to the three mass flow curves, it can be found that with the increase of mass flow rate, the temperature response of the battery is faster and faster, and the corresponding period is shorter and shorter. When the mass flow rate increases to a certain extent, the temperature change curve is basically the same, indicating that the model under logical control tends to be saturated under the influence of mass flow rate. Because the specific heat capacity of liquid is greater than that of air, the range affected by flow rate of liquid cooling is smaller than that affected by wind speed of air cooling. Therefore, within a certain range, the larger the mass flow rate, the better the liquid cooling effect of the battery and the faster the response.

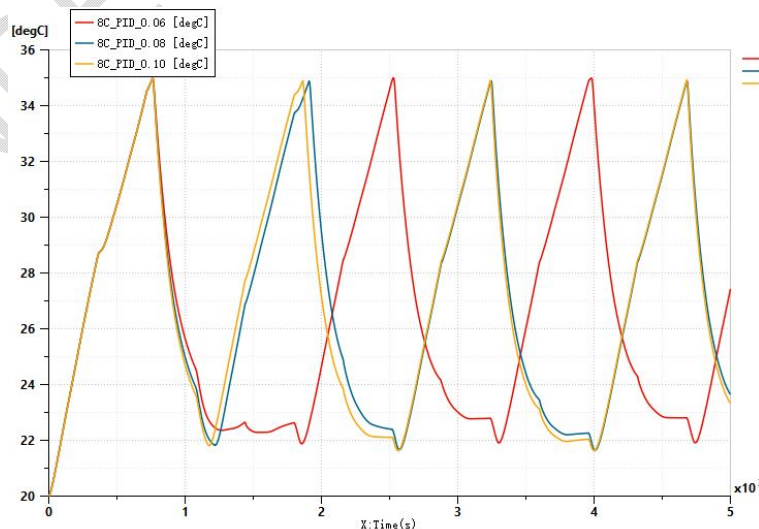

Figure 8. Curves of liquid cooling temperature under different mass flow rates

## 5.2 Analysis of battery cooling effect under different charging and discharging ratios

Battery charge/discharge ratio refers to the current value required by the battery to discharge its rated capacity within a specified period of time. It is equal to the multiple of the rated capacity of the battery on the data value, usually represented by the letter C. In this section, the total power of the system under stable operation is determined to be 300W based on the established models of air cooling, liquid cooling and new hybrid refrigeration, and the charging and discharging ratios of 4C and 8C are changed. The cooling effect of the battery was analyzed by the temperature rise curves of the three cooling models.

### 5.2.1 Analysis of Battery refrigeration at Low charge-discharge ratio

Figure 9 shows the charge-discharge temperature rise curves of three kinds of batteries at 4 times charge-discharge rate. According to the figure 7, at 4 times discharge rate, the battery temperature keeps rising, and the effect of air-cooled cooling is close to that of liquid-cooled cooling, eventually stabilizing between 33°C and 35°C. So that the second stage (35°C) transition is relatively stable, but when the temperature tends to stabilize, due to the large specific heat capacity of liquid cooling, resulting in inertial cooling fluctuations. Compared with the previous two cooling methods, the new cooling model with the mixture of liquid cooling and air cooling not only retains the transition stability of liquid cooling, but also ensures the stability of the result of air cooling. In addition, under the low power of the unified system, it can also effectively cool the system to ensure that the temperature is finally stable at about 30°C.

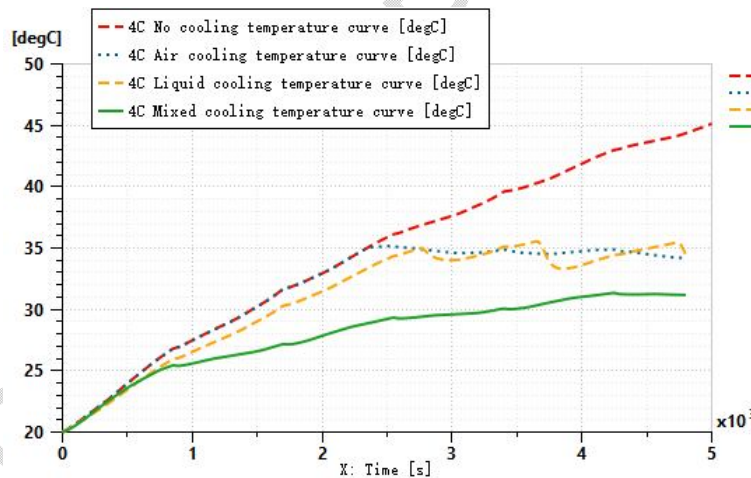

Figure 9. Temperature curves of thermal management of three kinds of batteries at 4 times charge-discharge ratios

### 5.2.2 Analysis of battery thermal management at high charge-discharge ratios

Figure 10 shows the temperature curves of three kinds of battery thermal management at 8 times charge-discharge ratio. According to Figure 10, when the battery is at 8 times the charge-discharge ratio, the cooling effect of air cooling decreases significantly, resulting in cooling saturation. The cooling requirements cannot be met, resulting in overheating of the battery. The temperature crosses the upper limit of logical control and finally stabilizes at 49°C. The overall effect of liquid cooling is close to that of the new cooling model with convection cooling and tends to be stable eventually. However, the cooling effect of liquid cooling and air cooling on the new cooling model with convection cooling is the best at 22°C to 35°C, and the transition from the first stage to the second stage controlled by logic is more gentle.

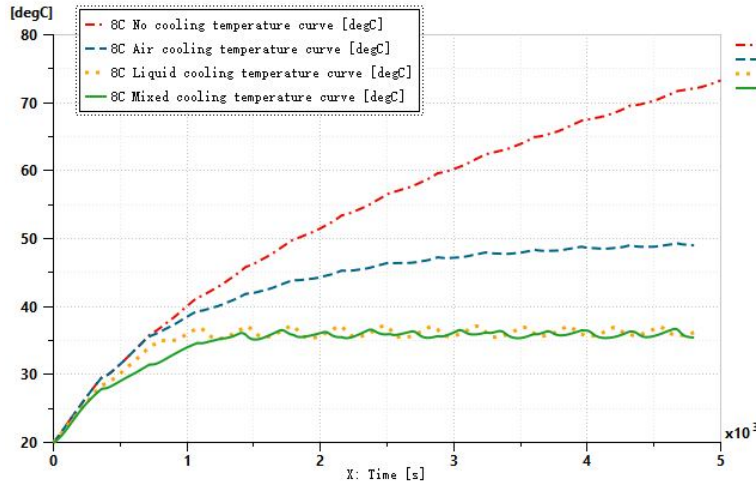

Figure 10. Thermal management temperature curves of three kinds of batteries at 8 times charge-discharge ratio

### 5.2.3 Analysis of battery thermal management at high charge-discharge ratios

Figure 11 shows the temperature rise curves of air cooling, liquid cooling, and mixed cooling for power battery temperatures at 4C and 8C charge-discharge ratios. As shown in Figure 11, comparing the natural temperature rise curve of 4C and 8C charging and discharging ratios, it can be found that with the increase of discharge ratio, the temperature rise effect of battery pack is obvious. At low charging ratio, the effect of air cooling, liquid cooling and mixed cooling is obvious, and the temperature difference is not big at the final equilibrium. However, when the charge and discharge ratio is high, the effect of air-cooling decreases, and the battery overheating occurs. At high charge-discharge ratio, the cooling effect is the best, the battery temperature curve is the gentlest, and the temperature at equilibrium is the most stable.

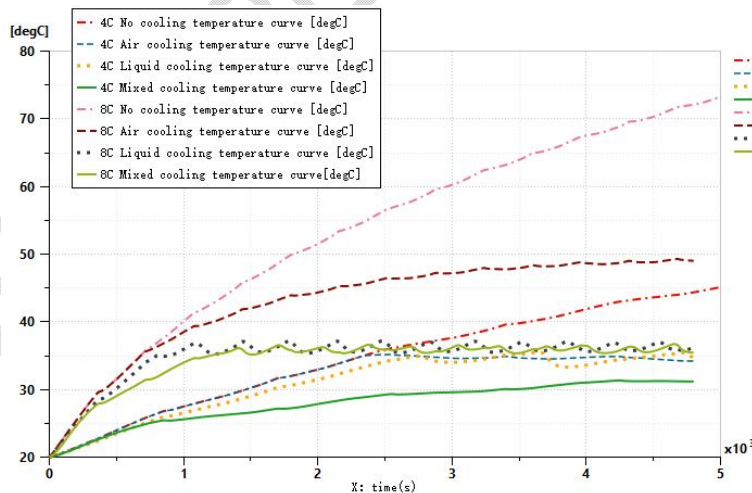

Figure 11. shows the temperature change curves of the three schemes under different charging and discharging ratios

### 5.3 Analysis of battery temperature uniformity under different cooling schemes

Thermal management of batteries is not only to cool the battery, but to ensure that the battery temperature on the basis of maintaining a balance, to ensure the overall thermal uniformity. The uniformity of temperature distribution in battery pack has significant influence on its performance

and cycle life. When the average battery temperature is lower and the temperature inequality degree is higher, the inconsistency of the discharge depth of a single battery in the battery pack is higher. When the average temperature is higher and the temperature is more uneven, the battery pack cycle life is shorter. Uneven temperature distribution leads to uneven current distribution among parallel branches, which is one of the important factors to accelerate battery aging rate. This paper mainly studies the cooling methods of three different inlet and outlet sides. In this structure, the lithium-ion battery at the inlet is first exposed to liquid or air-cooled fluid heat transfer and thus has a better cooling effect, while the cooling effect of subsequent batteries will gradually decline as the temperature of the fluid rises. The maximum temperature difference of the battery is mainly concentrated in the lithium-ion battery at the inlet of the fluid and the lithium-ion battery at the outlet of the fluid. This section will calculate the mean value of the inlet and outlet batteries respectively, and then make a comparative analysis, as the main basis for temperature uniformity.

### 5.3.1 Inlet and Outlet Temperature Analysis of different battery cooling Modes

Figure 12 (a), (b) and c show the temperature curves of battery inlet and outlet when air cooling, liquid cooling and opposite mixed cooling are respectively adopted at 8C charge-discharge ratios. In Figure (a) and (b), the curves of mean temperature at the inlet and outlet of air cooling and liquid cooling show an accompanying phenomenon, and the overall mean temperature at the inlet is lower than that at the outlet. As shown in Figure (c), liquid cooling and air cooling are different in structure from the former. The air cooling inlet side of the mixed refrigeration is the liquid cooling outlet side, and the two are cooled in the opposite direction. The liquid cooling inlet and outlet are selected as the standard in the figure. According to the logic control, when the initial battery is lower than 25°C, the air cooling system starts to operate at the highest power, showing a high temperature at the inlet and outlet of the air cooling side. When the temperature reaches 25°C, the liquid cooling system starts to operate at the lowest power. At this time, the inlet temperature starts to rise slowly, and the two meet at 29°C. Subsequently, the inlet temperature is lower than the outlet battery temperature, and finally tends to be stable.

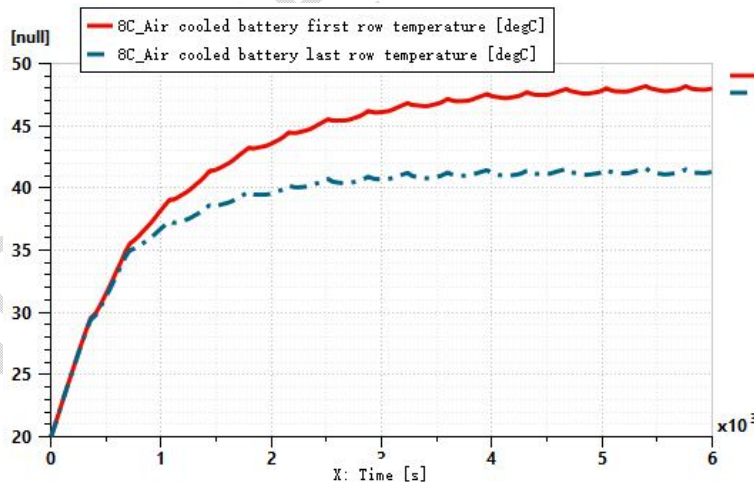

(a) Air cooled refrigeration battery inlet and outlet temperature

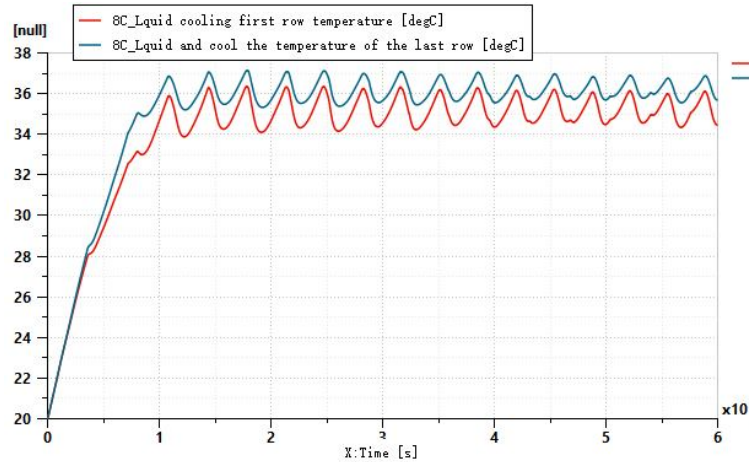

(b) Inlet and outlet temperature of liquid-cooled refrigeration batteries

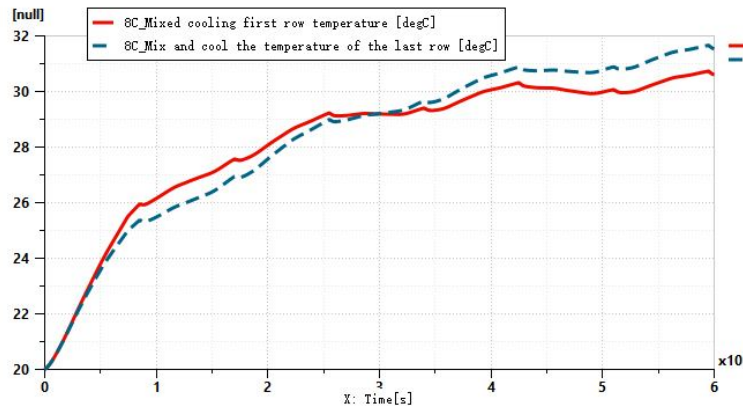

(c) Inlet and outlet temperature of hybrid refrigeration battery

Figure 12 Temperature curves at inlet and outlet of batteries with different cooling modes

### 5.3.2 Battery Cooling Temperature Uniformity Analysis

Figure 13 shows the maximum temperature difference curves of batteries under air cooling, liquid cooling and mixed cooling. According to the comparison of the three cooling methods, when the air cooling reaches the equilibrium, the temperature difference is the largest, and the maximum temperature difference is 7°C. The temperature difference between the liquid cooling and the mixed cooling is little changed, and the temperature difference between the liquid cooling and the mixed cooling is lower than 2°C, among which the mixed cooling effect is the best, and the balance temperature difference is only 0.5°C. According to the temperature curves of air-cooled cooling and liquid-cooled cooling, the comparison shows that the time for the temperature difference of air-cooled cooling to reach equilibrium is about four times that of liquid-cooled cooling. Compared with air cooling and liquid cooling, mixed refrigeration shows great advantages in various performance, the best stability, the smallest error, the best refrigeration effect.

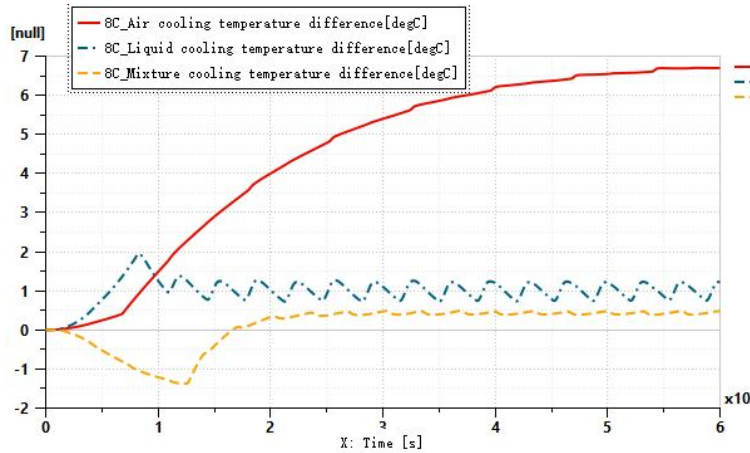

Figure 13. Curves of battery temperature differences under different cooling methods

### 5.3.3 Power changes of different cooling modes under logical control

Figure 14 shows the power variation curve during the cooling process of air cooling, liquid cooling and opposite mixed cooling under logical control. In the first stage, when the temperature of the power battery reaches the minimum starting limit, the system runs with the lowest power; In the second stage, when the battery temperature reaches the highest threshold, the system runs at the highest power to ensure the cooling effect. The liquid cooling module has one more logic control module than the air-cooling module. The logic control strategy is used to control the power of the cooling fan of the liquid cooling tube and the output power of the water pump. When the temperature reaches the threshold of liquid cooling and air cooling, both of them start to operate to realize the temperature control of battery packs. According to the power change curve of the three cooling modes in the figure, when the system tends to be stable, the total energy consumption of liquid cooling and air cooling is basically the same, and the energy consumption of air cooling is the largest. Combined with the temperature variation of the three schemes under different charge-discharge ratios in Figure 12 and the battery temperature difference analysis of the three cooling modes in Figure 13, the cooling mode of the hybrid cooling has a good cooling effect in the thermal management of the power battery.

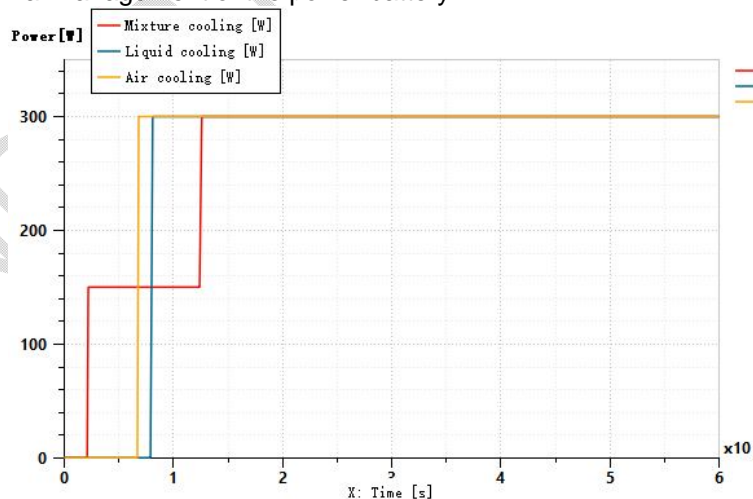

Figure 14. shows power variation curves of different cooling methods

## 6. CONCLUSION

Based on the analysis of the air-cooled cooling system and the liquid-cooled battery thermal management system under logical control, this paper proposes and analyzes the new antidiagonal mixed cooling, and analyzes the temperature rise of air-cooled and liquid-cooled cooling by changing the wind speed and liquid flow rate. According to the analysis of temperature changes under different charging and discharging ratios, at low charging and discharging ratios, air cooling can satisfy battery cooling, and the temperature is relatively gentle when it is stable. The liquid cooling system has a significant cooling effect in the transition stage of temperature rise, making the final temperature stabilize in a relatively gentle way, and the cooling effect is better than that of the air cooling system. The hybrid cooling system not only combines the advantages of air cooling and liquid cooling, but also embodies better advantages. The maximum temperature difference of batteries in the stable temperature of the hybrid cooling system is kept within 1°C, and the power is lower than that of air cooling and close to that of liquid cooling. Wind cold hot management technology although has the advantages of convenient installation, low cost, but under the control of the causes of poor air flow heat conduction ability at this stage cooling efficiency is too low, wind cold heat management technology cannot solve large scale, high energy density of new energy vehicles demand compared to the active way of thermal management. Liquid cooling heat management system has the advantage of high heat transfer coefficient, so it has better cooling effect. Many scholars have studied and improved direct liquid cooling and indirect liquid cooling. In order to further improve the cooling effect of liquid cooling, a novel inverse composite cooling model was proposed and verified by rationally arranging the cooling lines in parallel and combining the flow in and out of the liquid cooling and air cooling. Results show that of the composite cooling in cooling, temperature control, battery temperature uniformity, and power consumption are showed good performance. However, as a new solution of lithium ion battery thermal management, it still needs more exploration and research.

## REFERENCES

- [1] Yang Y. Research on dynamic Quantification method of urban road vehicle pollutant emission [D]. Southeast university, 2020. DOI: 10.27014 /, dc nki. Gdnau. 2020.000188.
- [2]. Annual Report on Environmental Management of China Mobile in 2022 (Excerpt 1) [J]. Environmental Protection,2022,50(23):64-72.
- [3] LI Zhengwang. The Status Quo and Development of Pure Electric Vehicles in China [J]. Silicon Valley,2014,7(19):5+3.
- [4] HU W. Modeling of Li-ion battery based on temperature effect and estimation of SOC based on EKF algorithm [D]. China mining university, 2020. DOI: 10.27623 /, dc nki. Gzkyu. 2020.000218.
- [5] Xiong Qing, Di Zhenguang, Ji Shengchang. Review of research progress on health State Estimation and Life Prediction of Li-ion Batteries [J/OL]. High Voltage Technology :1-14[2023-03-07].DOI:10.13336/ J.1003-6520.hve.20221843.
- [6]. Energy - Energy Storage; Studies from Chinese Academy of Sciences Update Current Data on Energy Storage (Revealing the Multilevel Thermal Safety of Lithium Batteries)[J]. Energy Weekly News,2020.

[7] Lin Chunjing, Xu Sichuan, Chang Guofeng, CAI Feilong. Experimental study on Temperature Uniformity of Lithium-ion Battery Pack for Electric Vehicle [J]. Automobile Technology,2014(10):55-58.

[8] Hu X, Xiong R, Egardt B. Model-based dynamic power assessment of lithium-ion batteries considering different operating conditions[J]. IEEE Transactions on Industrial Informatics, 2013, 10(3): 1948-1959.

[9] Zou Y, Hu X, Ma H, et al. Combined state of charge and state of health estimation over lithium-ion battery cell cycle lifespan for electric vehicles[J]. Journal of Power Sources, 2015, 273:793-803.

[10]Liu Zhaoen,Hu Zewei,Jiang Xueao,Wang Xiwen,Li Zhe,Chen Zhengjian,Zhang Yan,Zhang Shiguo. Metal - Organic Framework Confined Solvent Ionic Liquid Enables Long Cycling Life Quasi - Solid - State Lithium Battery in Wide Temperature Range[J]. Small, 2022, 17 (37).

[11] Hu Zhilin, Zhang Tianqiang, Yang Fang. Tesla electric vehicle [J]. Journal of thermal management technology development trend car abstract, 2021 (01) : 53-57, DOI: 10.19822 / j.carol carroll nki. 1671-6329.20200158.

[12] Chu Guangxin. Power lithium battery thermal characteristics analysis and battery pack structure research [D]. Tianjin university of technology, 2021. The DOI: 10.27357 /, dc nki. Gtgyu. 2021.000409.

[13]Zhang Furen,Yi Mengfei,Wang Pengwei,Liu Chongwei. Optimization design for improving thermal performance of T-type air-cooled lithium-ion battery pack[J]. Journal of Energy Storage, 201,44(PB).

[14]Ren Ruyang,Zhao Yaohua,Diao Yanhua,Liang Lin,Jing Heran. Active air cooling thermal management system based on U-shaped micro heat pipe array for lithium-ion battery[J]. Journal of Power Sources,2021,507.

[15]Xu Xiaoming,Tang Wei,Fu Jiaqi,Hu Donghai,Sun Xudong. The forced air cooling heat dissipation performance of different battery pack bottom duct[J]. International Journal of Energy Research,2018,42(12).

[16] Li Kangjing, Tan Xiaojun, Chu Yanyan, et al. Thermal management of Air-cooled lithium-ion power battery Pack for Vehicle [J]. Journal of Power Sources,2019,43(12):1975-1978+2035.

[17]Kai Chen,Mengxuan Song,Wei Wei,Shuangfeng Wang. Design of the structure of battery pack in parallel air-cooled battery thermal management system for cooling efficiency improvement[J]. International Journal of Heat and Mass Transfer, 2019132.

[18] Feng Shitong. Air-cooled power battery thermal management system and the structure optimization analysis [D]. Chongqing jiaotong university, 2019. The DOI: 10.27671 /, dc nki. GCJTC. 2019.000012.

[19] XIAO Han. Analysis and Improvement of Convective Heat Transfer Performance of an Air-cooled Power Battery System [D]. Beijing institute of technology, 2018. DOI: 10.26948 /, dc nki. Gbjlu. 2018.001883.

[20]Kai Chen,Mengxuan Song,Wei Wei,Shuangfeng Wang. Structure optimization of parallel air-cooled battery thermal management system with U-type flow for cooling efficiency improvement[J]. Energy,2018,145.

[21] ZHANG Lin. Optimization Design of thermal management System for liquid cooled Battery Based on flow resistance-thermal resistance Network Model [D]. Chongqing jiaotong university, 2022. DOI: 10.27671 /, dc nki. GCJTC. 2022.000169.

[22]Lei Sheng,Lin Su,Hua Zhang,Kang Li,Yidong Fang,Wen Ye,Yu Fang. Numerical investigation on a lithium ion battery thermal management utilizing a serpentine-channel liquid cooling plate exchanger[J]. International Journal of Heat and Mass Transfer,2019,141.

[23] Yi Mengfei. Composite design and research of lithium ion battery thermal management system [D]. Chongqing jiaotong university, 2022. The DOI: 10.27671 /, dc nki. GCJTC. 2022.000502.

UNDER PEER REVIEW