

## Original Research Article

# Smart Trash Collection System – An IoT and Microcontroller-Based Scheme

.ABSTRACT

**Aims:** IoT-based trash collection system is a system that can automatically detect obstacles, which can be simplified as trash, and opens the Meta Bin lid to receive the trash. The main goal of the system is to make an environment where to find a digital and automatic way to the trash collection system.

**Study design:** The existing research aims to design, simulate, and implement a new system that can play a vital role in terms of making the environment clean, in a large sense the world clean. Along with that a system that can carry not only a trash bin but also any portable devices as it can be operated automatically.

**Place and Duration of Study:** Department of Computer Science and Engineering and Department of Electrical and Electronic Engineering, American International University-Bangladesh (AIUB), Dhaka, Bangladesh between October 2022 and February 2023.

**Methodology:** In this work, we have designed a new model using Arduino, an IoT device, a servo motor, an ESP8266 Wi-Fi microchip, several DC motors, several IR Sensors, LEDs, etc. to build a system like Meta-Bin. Arduino IDE is used for program development.

**Results:** This is an automated trash bin, which has a different level of trash collection capacity with proper identifications and LED light indications. Also, a continuous notification system is enabled here. After testing the implemented system, the system gives an accurate result in every possible way and has an accuracy rate of more than 95%.

**Conclusion:** After the successful implementation of this research, we hope that there will be an autonomous, well-decorated, digital, and user-friendly system available for the citizens of Bangladesh. This will be immensely helpful for all kinds of people and to ensure a clean environment, this research might play a vital role soon.

*Keywords: Smart Bin, Arduino, Embedded System, Trash Collector, Automated System.*

## 1. INTRODUCTION

The recent world is becoming modern and advanced day by day. By this time, the population is rapidly growing and hence the amount of waste is increasing at the same rate. However, with this growing population and waste, there is a cumulative demand for waste management efficiently, especially in the bigger municipalities. As such, most of the roads remain impure and emit foul odors that pollute the environment. Especially in major cities, we observe that garbage is scattered here and there on roads and garbage baskets overflow with dirt. In addition to that, heavy bins are cumbersome to pull from one place to another.

The world generated about 2.24 billion tons of solid waste, where the per-person generated amount was 0.79 kilograms in the year 2020 [1]. It is expected that from 2020 to 2050, waste generation will increase by 73%. In all nations, these massive wastes are not well managed. For these reasons, a variety of health problems arise either directly or indirectly [2], such as directly through the production of solid waste and indirectly through the pollution of the air, soil, and water. Electrical waste has a significant impact on the environment, harms people's health, and pollutes the ecosystem [3]. Additionally, it was found that about 13 tons of

hazardous waste are produced every second. A total of 400 million tons of unsafe waste are being generated in the world every day [4]. There are other wastes also, for example, plastic waste, industrial waste, sanitary waste, paper waste, batteries, and food waste that cause harmful diseases in humans [5]. The waste affects the human lungs and damages other parts of the body. Organic waste creates methane gas and carbon dioxide gas. These gases are known as greenhouse gases that contribute to global warming and climate change [5]. As a result, the amount of waste generated globally must be considered and appropriate action must be taken.

By considering the above issues, this study aims to make the waste management system easier and smarter. This research work is designed to make a smart device that can follow humans anywhere and collect trash autonomously. In many countries, roadside bins are insufficient to collect all garbage. Furthermore, those road bins are large and heavy, making it difficult to move them from one location to another. This smart device can help to reduce trouble for the people who collect trash from roads. By putting such devices on the streets, the task of collecting garbage can be made easier and faster. The smart device is controlled entirely by an Arduino microcontroller. IoT is linked to make the process easier for authorities and to provide all instructions from a single system as well as to monitor the whole process. A huge amount of waste is produced every day, the management process needs more attention, monitoring, and supervision. This research work aims to improve the waste management systems in countries, like Bangladesh by making waste disposal easier, faster, smarter, and hygienic. The municipal authority or city corporations of Dhaka city must take steps to the waste management systems smarter.

## 2. LITERATURE REVIEW

Microcontroller-based system design has become very popular in various spheres of life, from biomedical systems to pisciculture systems, distance measurement systems, education systems, firefighting, and hazardous system design and implementation [6-14].

In [15], the authors introduced an automated vehicle that is used to follow the elderly person and give them some services in daily life. To build this automated system, the authors used Arduino with an ultrasound sensor. They connected the system with the IoT. To build global communication, they used wireless networks. Then they proposed an android application system to run this system and used the MySQL database system to store data.

The authors of the paper [16] have introduced a smart trash bin. The authors in their work claimed that their system consumes less energy. To implement their idea, they used a solar cell to recharge the battery of that device. However, they used a microcontroller system with an ultrasound sensor, and to connect with the internet they enabled a wireless communication system with it.

In [17], the authors introduced a system that notified the users when the trash bin is full. To build this autonomous system, the authors used Arduino UNO with ultrasonic sensors, and to control the bin they used servomotors. They introduced a new approach here that the system would notify the user, to make this thing happen they used a GSM module to send messages. Besides, they used a buzzer system to generate an alarm as per the system's need.

In the article of reference number [18], the authors introduced a new smart trash system with ARM LPC2148 with an ultrasonic sensor and GSM module. This system can notify the users by giving an alert. They also used an HTTP request to send the sensor data to the user's device. They also used a wireless network to connect this system with the IoT.

In another research paper of reference [19], the authors introduced a new system. It can detect and classify waste. There are 3 types of waste categories it can divide. They used a stereo camera to take real-time images of an object and used the Haar-Cascade technique to detect the trash nearby. With a minimum of 63.5% and a maximum of 82.7% accuracy, their system could work in both online and offline modes.

Through this paper, a new method has been introduced in terms of designing and implementing an innovative way to go one step further in making the environment clean and techy using Arduino ATmega2560. Besides, this system can be used as a portable device.

**Comment [pa1]:** show the advantages of previous researchers

### 3. PROBLEM STATEMENTS AND OBJECTIVES

In this paper, a human following bot for trash collection is designed. This smart device is mainly made of Arduino ATmega2560 microcontroller [20]. To follow humans and detect trash automatically, various sensors and detectors are used. For example, sensors, like sonar sensors [21], IR sensors, etc., and other components, like DC motors, LEDs, SD card modules, motor drivers, ESP8266, speakers, and amplifiers are used to implement the whole system. The precise objectives of this study are to-

- i) Find how an autonomous system can help in people's daily life.
- ii) Design an Arduino-based smart device.
- iii) Develop an autonomous system that will collect trash in a smarter way
- iv) Create a better environment for trash management.

This research work could benefit people who collect trash from the streets and simplify the waste management system. This smart device can help minimize difficulty because those road bins are large and heavy. The garbage disposal system will be structured and the process of disposing of waste will be made easier if the government installs such devices on the streets. This will help keep the streets clean.

### 4. COMPONENT DESCRIPTION

i) *Arduino ATmega2560*: Arduino ATmega2560 is an AVR-based microcontroller board that hasan ATmega2560 microprocessor chip and other relevant peripherals. It has a total of 54 digital pins and 16 analog pins for input/output. This is a very cheap and widely available product [20].

ii) *DC Motor*: DC Motor is an electrical machine, which works under DC power. Used to convert electrical energy to mechanical energy [22].

iii) *Servo Motor*: A servo motor is a kind of highly efficient electromechanical machine that can rotate an object connected to its shaft with great precision and accuracy, and as a result, it can control the speed, linear or angular displacement, acceleration, etc. with minute details.

iv) *Motor Shield*: It is a driver unit for a motor that controls the speed as well as the direction of rotation of the motor [23].

v) *IR Infrared Obstacle Avoidance Sensor*: The infrared LED emanates a light signal at an infrared wavelength. When an object falls on the same route of this optical signal, it is reflected by that object and the IR receiver receives that reflected signal [23]. The anode terminal of the infrared LED is connected to the output pin of the microcontroller's corresponding port.

vi) *Ultrasonic Sonar Sensor*: It is an electronic device to detect any object placed in front of it. It does so by emitting an ultrasonic wave through its Trigger pin connected to the output port pin of the microcontroller and receiving the echo of that wave from the object by its Echo pin connected to the input pin of the microcontroller's corresponding port [21]. It is powered by the DC voltage source, usually of a five volts supply taken from the microcontroller board.

vii) *Wi-Fi Wireless Transceiver*: It is a combination of transmitter and receiver in a single package. It is used in wireless communications devices to transmit or receive signals [24].

viii) *Arduino MicroSD Card Module*: It is a kind of digital device that communicates with the memory card module and writes or reads data into it.

### 5. HARDWARE DESIGN AND IMPLEMENTATION

In recent days, people want to make their work easier. For this purpose, the human following device can help. The hardware design and implementation have two phases of work-simulation setup and test. After that, the hardware assembly of the whole system and performance test.

**5.1 Implementation** - The whole research work can be differentiated into two categories; they are the Buzz and the Meta Bin. Figure 1 demonstrates the block diagram of the entire system. It is described in two parts in the next two sub-sections.

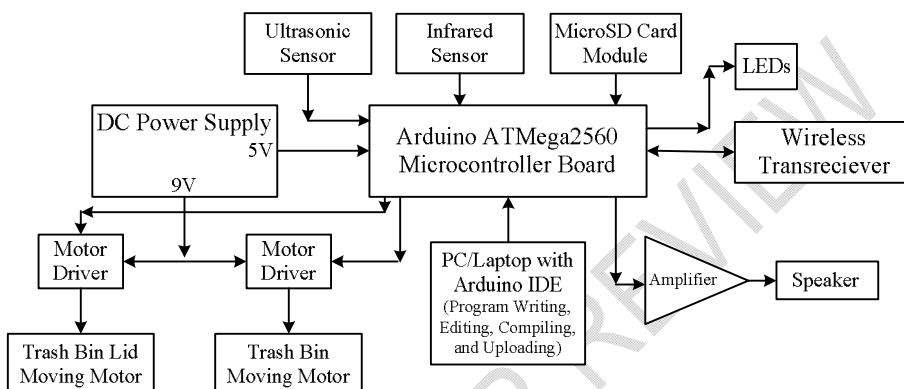

**Fig. 1. Block diagram of the whole diagram**

**5.1.1 Working procedure of BUZZ** - This research work is about designing and implementing a smart device, named Meta Bin. This device works on Arduino Mega 2560 microcontroller. Obstacles, in front of the device, are detected by an ultrasound sensor and the smart bin is controlled by a servo motor. There are three ultrasound sensors for detecting an obstacle in front of a smart device, detecting an obstacle in front of a meta bin, and detecting obstacle distance inside the bin. Two servomotors control the head of the smart device and bin lid. DC motors move the vehicle and a motor driver be used to send signals to it for its proper operation. In front of the car, there is an ultrasonic sensor to move the car according to the hand or obstacle movement. Besides, there are two infrared (IR) Sensors used on the right and left side of the car to move the car left and right. A battery with 7-8 V has been used to move the car. We used the motor shield along with the Arduino ATmega to control the DC motors through the microcontroller. The flowchart of the program for this part is denoted in Fig. 2 (a).

**5.1.2 Working procedure of Meta Bin** - Meta Bin is a smart device that can follow humans or other objects in any situation. By using sensors, it can detect obstacles in front of it, and move from back to forth and left to right with flexible movement. In addition, there will be an auto trash bot that will open/ close the bin lid by sensing obstacles in front of it. The sensor inside the bin can detect three different levels of waste, such as low, medium, and high levels. The trash bot will show the level of trash inside the bin by lighting the LEDs with different colors. The red LED specifies the high level, the yellow LED specifies the medium level, and the blue LED specifies the low level of the trash inside the bin. Besides, there is another green LED to indicate the idle state of the bin, a yellow LED for showing the trash bot is opening its lid, and a red LED to show its overflow state. After crossing the high layer, the trash bot lights its red LED and the trash bot goes to an overflow state. At this stage, the

trash bot will not open its lid. There is a switch to open the lid manually when the trash bot is in overflow mode. The flowchart of the program for this part is depicted in Fig. 2 (b).

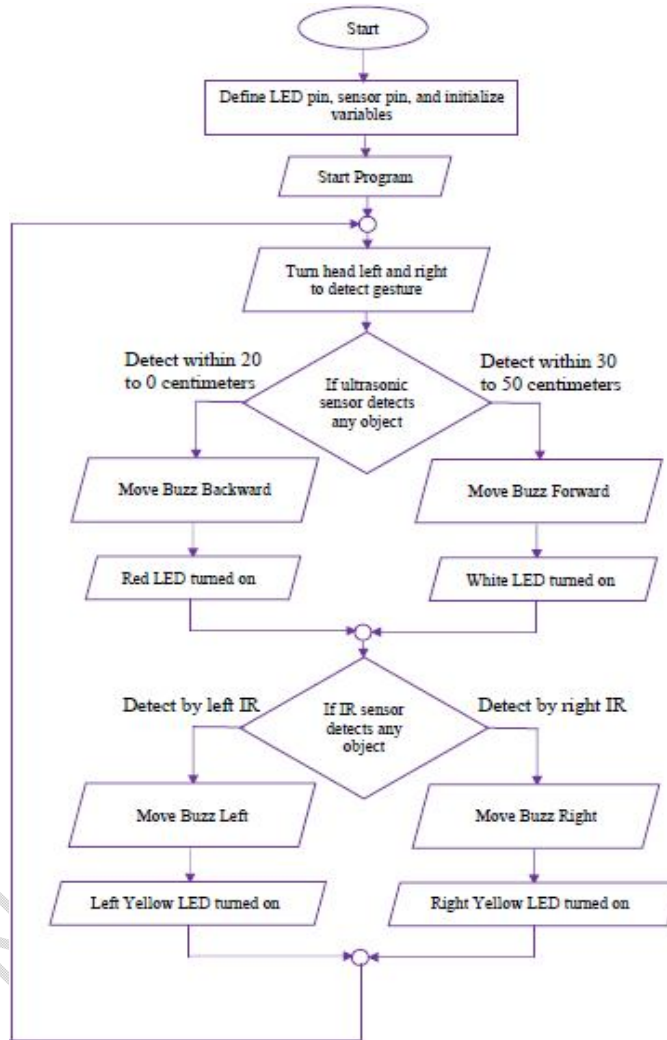

Fig. 2. Flow chart of the program: (a) for the Buzz

initial  
Double sta

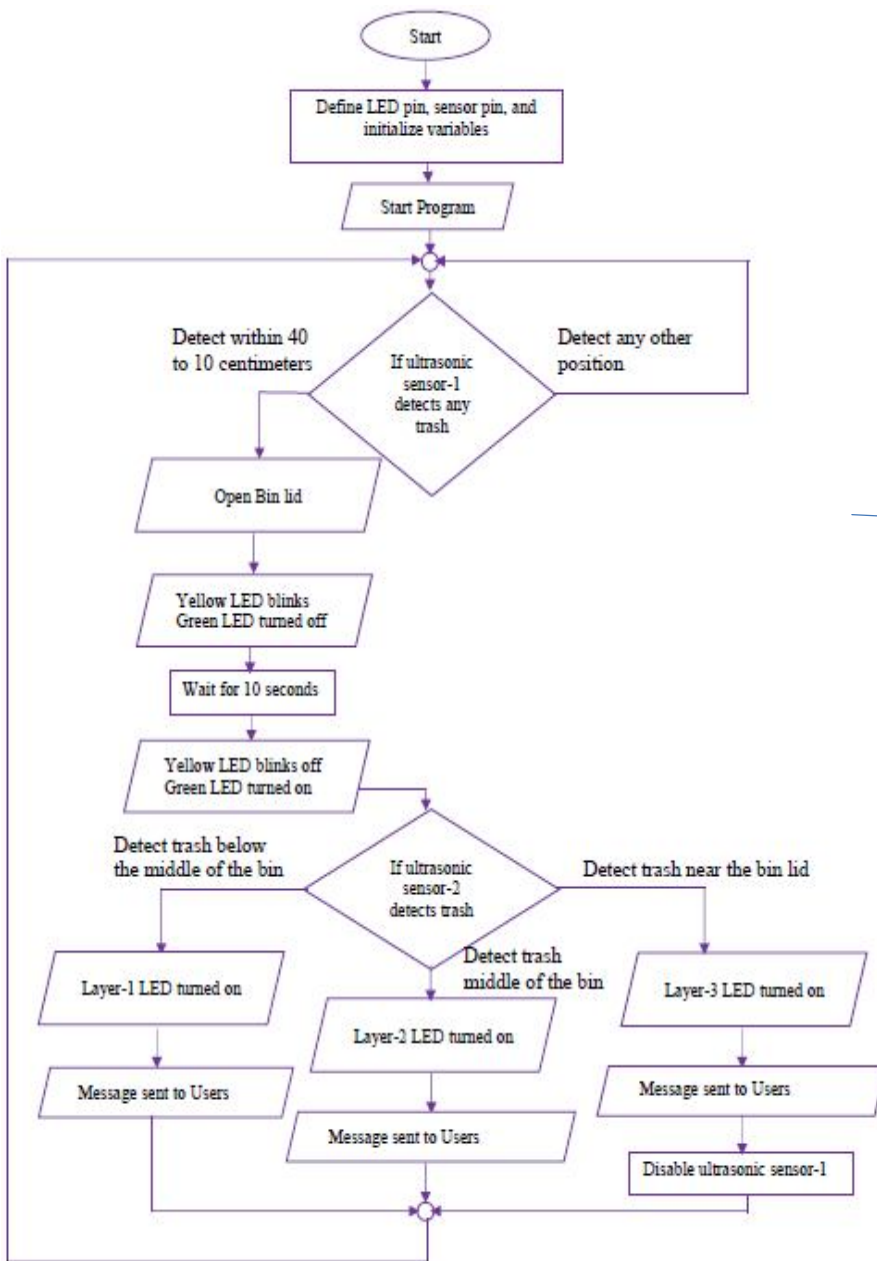

Fig. 2. Flow chart of the program: (b) for the Meta Bin

→  
→ Double start

→ process

**5.2 Simulation and Software Implementation-** For the simulation purpose, we have used the simulation software Proteus. In addition, some external library functions have been used in this case like Arduino ATmega2560 library, IR sensor library, ultrasonic sensor library, etc.

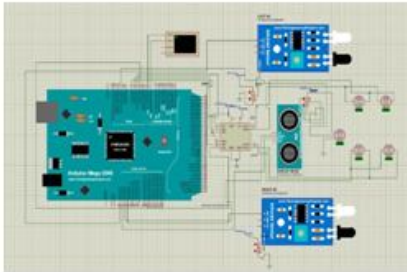

Fig. 3. Software Circuit diagram of BUZZ

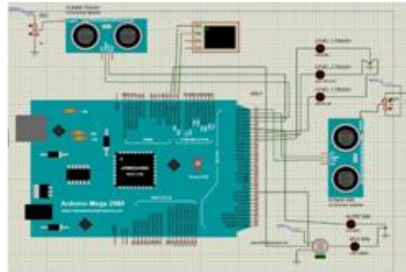

Fig. 4. Software Circuit diagram of Meta Bin

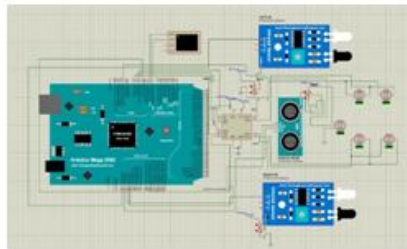

Fig. 5. Software Circuit diagram of BUZZ in OFF state

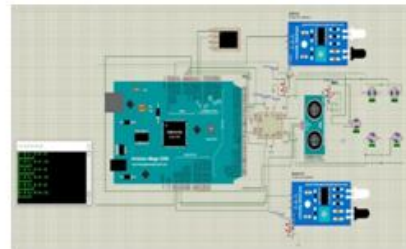

Fig. 6. Software Circuit diagram of BUZZ in ON state

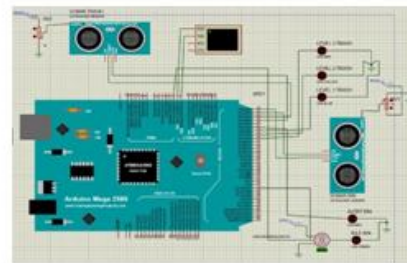

Fig. 7. Software Circuit diagram of Meta Bin in OFF state

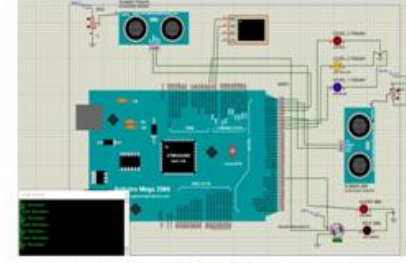

Fig. 8. Software Circuit diagram of Meta Bin in ON state

**5.3 Hardware Design and Implementation** -After successfully designing the simulation on Proteus, we implemented the whole system in a hardware-based system to get real-time results from it.

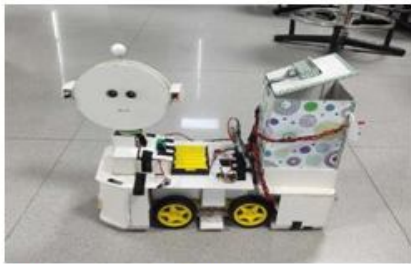

Fig. 9. Front Left-View



Fig. 10. Front Right-View



Fig. 11. Front View of BUZZ  
(Lights Off)



Fig. 12. Front View of BUZZ  
(Lights On)



Fig. 13. Rear View of Meta Bin (Lid Down)



Fig. 14. Rear View of Meta Bin (Lid Up)



Fig. 15. Upper view of the system



Fig. 16. Arduino ATmega2560 after connections

## 6. RESULTS AND DISCUSSIONS

**6.1 Experimental Results-** When the ultrasonic sensor of the smart device detects obstacles between 20 to 40 cm, it goes forward. When the distance is less than 15 cm, it goes backward. When the distance is between 15 to 20 cm, it stops. For Meta Bin, the bin lid opens when the distance is between 12 to 20 cm. To detect the level of trash inside the bin, three types of distances are measured. For low level, the distance is 12 to 15 cm; for medium level, the distance is 9 to 12 cm; for high level, the distance is 4 to 9 cm, and for overflow condition, the distance is less than 4 cm.

We have used the IoT device along with the microcontroller and have built a dedicated system to know the status of the bin and its conditions of it. After running a test, we found the following findings from our experiment results:



Fig. 17. Bin status: Idle



Fig. 18. Website view for the Bin when Idle

i) At the very beginning of the system, the bin status will be idle and it depicts that it can now receive trash from the users. Moreover, at this stage, the Green LED will be turned on to show the status. In the website, we can see the same status as shown in Figs. 17-18.

ii) When the bin's lid is made open to receive the trash, the bin status will be busy and the yellow LED will be lit up. The website will be updated according to the status of the bin. This is observed in Figs. 19-20.



Fig. 19. Bin status: Busy



Fig. 20. Website view for the Bin when Busy

iii) When the trash bin is not fully occupied and still can receive trash, the Yellow LED light turns on at the right side and the information is updated on the website; it specifies that the trash level is medium. This is shown in Figs. 21-22.



**Fig.21.Trash Level: Medium**

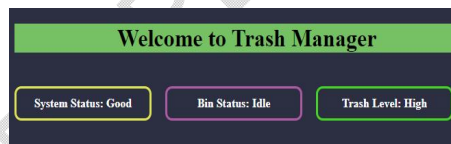

**Fig.22.Website view for the Trash level medium**

iv) When the trash bin is fully occupied, the Red LED light on the right will be lit up and it will indicate that the bin is full, and the website updates its information as shown in Figs. 23-24.



**Fig.23.Trash Level: High**

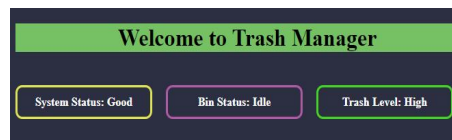

**Fig.24.Website view for the Trash level high**

v) When the smart trash bin is extremely occupied and there is no further space to collect any more trash, the bin status shows the red LED, which signpoststhe overflow condition, and the trash level LED shows that it is fully loaded. Moreover, if the bin status is overflowing then the lid of the bin will not beopened anymore and to open the lid, there is a manual switch, which needs to be pressed once manually. The website updates the same status as in Fig. 25-26.



**Fig.25.BinStatus: Overflow**



**Fig.26.Website view for the overflow status**

Here, Proteus simulation software is used to design and conduct the simulation. The simulation results are very much like that of the calculated results. For the estimated distances, we got the same results during the simulation.

**6.2 Cost**-Table 1 shows the total cost of the research work. As this one is the testing prototype, the cost may vary a little bit because when we go for the massive scale production, the cost may be greater or lesser than the present one because we may need to scale up this prototype. We see that the total cost involved for the prototype design is BDT6,000.00 (that is, only six thousand Bangladeshi takas), which is equivalent to US\$60 (US Dollars sixty only), approximately.

**Table 1. Cost analysis of the design**

Equipment	Quantity (pcs)	Cost (BDT)
Arduino Mega 2560 R3	1	2000
Mini Servo Motor	2	300
Motor Shield	1	250
IR Obstacle Avoidance Sensor	2	200
Ultrasonic Sensor	3	300
Wi-Fi wireless transceiver	1	250
Arduino MicroSD Card Module	1	300
DC Motor	4	400
Speaker	1	200
Others (LED, wires, etc.)	-	1800
<b>Total Amount (BDT)</b>		<b>6000</b>

**6.3 Comparison** -The results we got from the simulation and the result from the hardware implementation do not differ too much. Both the results are accurate according to our expected results. The hardware test results are very satisfying as it gives visuals of the actions. Although, the calculated results are mostly the same as the simulation results and the percentage of error is only 0.02%.

**6.4 Limitations** -This task is about an autonomous smart device that collects trash. However, the device is not fully autonomous. It follows any object when it detects an obstacle in front of it. In the future, it can be made fully autonomous. Another thing is that the trash bot only detects obstacles. Implementing the detection of trash through various other sensors will make the smart device more accurate.

## 7. CONCLUSIONS

The proposed smart trash collecting system is an IoT-based system that can collect trash autonomously in real time. This smart device is designed in such a way that it can follow people from anywhere. In addition, if any incoming trash is detected, the lid of the bin is opened and thereby storing garbage there. To determine the amount of waste in the bin, there are three layers defined for three different amounts of garbage, such low, medium, and high levels. It can send signals to the control room if the garbage level of the bin is high. The proposed technique can therefore help those who pick up waste from the streets while also saving money for the municipality's transportation department. The evaluation of this system successfully managed to detect human gestures and collect garbage.

Finally, the trash management system will significantly change as a result of this research initiative. The environmental conditions would be improved and the streets would be cleaner if a trashbin like this could be established in different areas of the city. As those road bins are big and heavy, this smart device can help to reduce trouble. The procedure of collecting

trash will make the garbage collector's job easier and would save lots of time. This research enables trash collecting and an easy management process. To do further work with this study, video image processing can be used to detect only trash for the bin. This system can be scaled up to a main trash management system that will manage the whole area-based trash collecting system from any corner of the earth within a moment. To collect more useful data, additional monitoring sensors might be attached to the body of the car.

## REFERENCES

1. World Bank Group. (2022, May 31). Solid waste management. World Bank. Retrieved February 10, 2023, from <https://www.worldbank.org/en/topic/urbandevelopment/brief/solid-waste-management>.
2. Wikimedia Foundation. (2023, February 6). Waste management. Wikipedia. Retrieved February 10, 2023, from [https://en.wikipedia.org/wiki/Waste\\_management](https://en.wikipedia.org/wiki/Waste_management).
3. Environment, U. N. (n.d.). Solid waste management. UNEP. Retrieved February 10, 2023, from <https://www.unep.org/explore-topics/resource-efficiency/what-we-do/cities/solid-waste-management>.
4. Hwhenvironmental. (2022, April 18). Facts and statistics about waste for 2022. HWH Environmental. Retrieved February 10, 2023, from <https://www.hwhenvironmental.com/facts-and-statistics-about-waste/>, accessed on 22 February 2023.
5. Waste: A problem or a resource? European Environment Agency. (2021, November 5). Retrieved February 10, 2023, from <https://www.eea.europa.eu/publications/signals-2014/articles/waste-a-problem-or-a-resource#:~:text=Air%20pollution%2C%20climate%20change%2C%20soil,gas%20linked%20to%20climate%20change>, accessed on 22 February 2023.
6. M. S. Ali and M. H. Bhuyan, "Design and Implementation of a Low-Cost Blood Pressure Measuring Device," Proceedings of the IEEE International Conference on Electrical and Computer Engineering, Bangladesh University of Engineering and Technology, Dhaka, 20-22 December 2018, pp. 309-312.
7. M. H. Bhuyan and M. Sheikh, "Designing, Implementing, and Testing of a Microcontroller and IoT-based Pulse Oximeter Device," IOSR Journal of Electrical and Electronics Engineering (IOSR-JEEE), ISSN: e-2278-1676, p-2320-3331, vol. 16, issue 5, series-2, September-October 2021, pp. 38-48.
8. M. H. Bhuyan, S. D. Monty and M. R. Z. Sarkar, "Design and Implementation of a NIR-Technique Based Non-Invasive Glucometer using Microcontroller," Journal of Bangladesh Electronics Society, ISSN: 1816-1510, vol. 19, no 1-2, June-December 2019, pp. 75-84.
9. M. H. Bhuyan, M. T. Hasan and H. Iskander, "Low-Cost Microcontroller Based ECG Machine," International Journal of Biomedical and Biological Engineering, vol. 14, no. 7, 2020, e-ISSN: 1307-6892, pp. 192-199.
10. M. H. Bhuyan, and S. S. A. Khan, "Assessing and Evaluating the Course Outcomes of Electrical Circuit Course for Bachelor of Science in Electrical and Electronic Engineering Program," International Journal of Educational and Pedagogical Sciences, ISSN: e-1307-6892, vol. 14, no. 12, 2020, pp. 1163-1171.
11. M. H. Bhuyan, "Assessing 'lifelong learning' through the capstone design project of BSc in EEE program," International Journal of Learning and Teaching, 1986-4558, vol. 13, issue 1, 2021, pp. 13-31.
12. M. H. Bhuyan, "Guidelines for Developing, Supervising, Assessing and Evaluating Capstone Design Projects of Undergraduate Electrical and Electrical Engineering Program," International Journal of Educational and Pedagogical Sciences, ISSN: e-1307-6892, vol. 15, no. 1, 2021, pp. 80-91.

13. M. H. Bhuyan, M. A. Ali, S. A. Khan, M. R. Islam, T. Islam, and J. Akter, "Design and Implementation of Solar Power and an IoT-Based Pisciculture Management System," *Journal of Engineering Research and Reports*, ISSN: 2582-2926, vol. 24, issue 2, Article no. JERR.95811, January 2023, pp. 15-27.
14. A. H. Adnan, M. N. Sadik, A. T. Mamun, T. S. Shefat, and M. H. Bhuyan, "Design, Simulation, and Implementation of a Surveillance Robot System," *Proceedings of the International Conference on Electronics and Informatics*, Bangladesh Electronics and Informatics Society (BEIS), Bangladesh Atomic Energy Center (BAEC), Dhaka, Bangladesh, 26-28 January 2023, p. 98.
15. Chu, H.C., Chien, M.F., Lin, T.H. and Zhang, Z.J., 2016, July. Design and implementation of an auto-following robot-car system for the elderly. In 2016 International Conference on System Science and Engineering (ICSSE), pp. 1-4. IEEE.
16. Utomo, S.K.T., Hamada, T. and Koshizuka, N., 2018, June. Low-energy smart trash bin architecture for dynamic waste collection system. In *Proceedings of the 2nd International Conference on Future Networks and Distributed Systems* pp. 1-7.
17. Abidin, A.R., Irawan, Y. and Devis, Y., 2022. Smart Trash Bin for Management of Garbage Problem in Society. *Journal of Applied Engineering and Technological Science (JAETS)*, 4(1), pp.202-208.
18. Samann, F.E., 2017. The design and implementation of smart trash bins. *Academic Journal of Nawroz University*, 6(3), pp.141-148.
19. Salimi, I., Dewantara, B.S.B. and Wibowo, I.K., 2018, October. Visual-based trash detection and classification system for smart trash bin robot. In 2018 International Electronics Symposium on Knowledge Creation and Intelligent Computing (IES-KCIC) (pp. 378-383). IEEE.
20. A. A. Mansur, B. C. Shill, and M. H. Bhuyan, "Design and Development of PC Based Elevator Control Systems via ATmega32 Microcontroller," *Southeast University Journal of Science and Engineering (SEUJSE)*, ISSN: 1999-1630, vol. 10, no. 1, June 2016, pp. 102-107.
21. R. Titlee and M. H. Bhuyan, "Design, Implementation and Testing of Ultrasonic High Precision Contactless Distance Measurement System Using Microcontroller," *Southeast University Journal of Science and Engineering (SEUJSE)*, ISSN: 1999-1630, vol. 10, no. 2, December 2016, pp. 6-11.
22. M. K. Russel and M. H. Bhuyan, "Microcontroller Based DC Motor Speed Control Using PWM Technique," *Proceedings of the International Conference on Electrical, Computer and Telecommunication Engineering (ICECTE)*, Rajshahi, Bangladesh, 1-2 December 2012, pp. 519-522.
23. N. K. Paul, D. Saha, R. T. Islam, M. M. Marufi, S. Akter, and M. H. Bhuyan, "Meta Bin – An Arduino-Based Smart Device for Collecting Trash," *Proceedings of the International Conference on Electronics and Informatics*, organized by the Bangladesh Electronics and Informatics Society, Bangladesh Atomic Energy Center (BAEC), Dhaka, Bangladesh, 26-28 January 2023, p. 63.
24. M. H. Bhuyan, "Wireless Control System for DC Motor to Position a Dish Antenna Using Microcomputer," *Daffodil International University Journal of Science and Technology*, 1818-5878, vol. 2, issue 1, pp. 44-49, January 2007.

**Comment [pa2]:** the writing of abbreviated names is inconsistent

**Comment [pa3]:** the writing of abbreviated names is inconsistent

**Comment [pa4]:** inconsistent year writing

**Comment [pa5]:** the writing of abbreviated names is inconsistent

**Comment [pa6]:** inconsistent year writing

**Comment [pa7]:** inconsistent year writing

**Comment [pa8]:** inconsistent year writing