

Original Research Article **DESIGN AND IMPLEMENTATION OF OPTIMIZED CONTROLLER FOR E-VEHICLES**

ABSTRACT

There is a shortage of fossil fuels, and air pollution due to CO₂ emissions from internal combustion engines is harmful to the environment. Hence, electric vehicles (EVs) play a vital role in the automotive sector by decreasing CO₂ emissions and reducing the usage of fossil fuels. The performance of EVs is also comparable to that of internal combustion engines used in automobiles. The faithful operation of an EV relies on three main parts: the battery, controller, and motor. This proposed research article emphasizes the design, implementation, and testing of a low-cost EV controller that operates at a lower frequency than other conventional high-frequency controllers. A PMDC motor is used as a load to rotate the wheels, and a Lithium-Ion battery powers the electric vehicle. The controller, which is the major part of the vehicle, is used to control the PMDC motor. The controller controls the output voltage, and the converter is controlled by the controller. Compared to conventional vehicles or transport, electric vehicles are more efficient, and this E-vehicle's load capability will be increased. The ripple of the output voltage from the converter will be reduced by adding capacitors.

Keywords: E-Vehicle Controller, Converter, Controller, Duty cycle, PWM, PMDC motor

1. INTRODUCTION

The energy crisis is a major concern in today's world due to the rapid depletion of resources of petrol and diesel. The advancement of electric vehicles (EVs) has become necessary due to increasing fuel costs, a lack of energy resources, and the need to reduce greenhouse gas emissions. The advantages of using EVs include being a source of clean energy, having high efficiency when compared to conventional vehicles, and producing less noise.

Several research articles have been published on EV technologies, and some related literature surveys have briefly discussed these advancements.

Pritam Keshavdas and Nizwa have proposed a way to reduce emissions in cities by motivating the use of bicycles and converting a conventional bicycle into a plug-in hybrid electric bicycle for low-distance commuters [4]. A replacement of motorized two-wheelers by converted plug-in hybrid electric bicycles for low-distance commuters is proposed.

Lorenzo Stilo, Heinz Lugo, Diana Segura Velandia, Paul P. Conway, and Andrew A. West have proposed a paper to reduce traffic congestion and CO₂ pollution by replacing Electric Bicycles and

conducting the analysis of commuters based on the distance provided in detail along with emissions implications [28].

Angalaeswari. S, Amit Kumar, Divyanshu Kumar, and Shubham Bhadoriya have proposed a paper on speed control of a Permanent Magnet DC (PMDC) motor done using Lab VIEW interfaced with Arduino and the Lab VIEW [7] is done in Proteus Simulation and with Different interfacing software like LIFA and LINX is used to interface Lab VIEW and Arduino, the main advantage of using Lab VIEW with Arduino is keeping the cost low and simple in structure.

Chyi-Ren Dow, Shun-Ming Chang, Van-Tung Bui, and Pei Liu have proposed a vibration reduction system for e-bikes while cycling by using an accelerometer for data collection [8] and feature extraction on the bumpy road by combing the geographical information for classification and use the classified results for e-bikes and developing a power assistant mode mapping and implement a system prototype and evaluate the performance of the prototype.

Zhu Deyi¹, Zhang Kai¹, and Yin Dejun have proposed a way to reduce the pedal force and relieve the fatigue of the rider by proposing a paper on the New Torque Control Approach for Electric Power Assisted Bicycle Based on Model-Following Control [9] which can eliminate the impact of the road grade and the load by processing the signal of speed and trample force on the bicycle. Accordingly, the torque of the motor can be adjusted to achieve the optimal effect of assisted power in real time. As result, the rider will obtain a better riding experience. The simulation and analysis demonstrate the effectiveness and performance of the proposed torque control approach.

George K. Kostopoulos has proposed a paper that analyzes the configuration of the 555 Timer from the pulse-width and frequency modulation viewpoint [11], derives the governing expressions, and provides practical nomograms for the design and analysis of pulse-width and frequency modulators with Suitable examples. The limitations of the commercially available 555 Timer can easily be overcome by employing discrete components in the implementation along with high-speed voltage comparators and gates.

Upasana Sarma and P.K Bordoloi have proposed the Speed Control of A DC Motor Using PLC and PIC Microcontroller [13] and the speed of a Permanent Magnet Direct Current (PMDC) motor is controlled under load conditions by a PID Controller simulated in the PLC Platform using the Siemens step S7 software which has better response and less error.

R. Thangasankaran, S. Parthasarathy, P. G. Harish Prabu, R. Praveen Thiagarajan, and R. Arun Kumar have proposed a paper on MATLAB/Simulink analysis of a ripple-free high-efficiency buck-boost type converter for EV charging and controlling applications [23]. which is a SEPIC Buck-Boost type converter achieving high efficiency by increasing the switching frequency and Modulate the Pulse Width this SEPIC converter is much suitable for high-voltage applications and operates in Continuous Conduction Mode which also increases the efficiency and Analysis are made for both Open-Loop and Closed-Loop of the Converter in MATLAB/Simulink.

2. EV CONVERTER TOPOLOGIES

Power device technology has made huge progress in the evolution of electric vehicles. The major function of a converter in an EV is to control the speed of the vehicle by triggering the gate pulse with the help of a pulse generator to the converter. By this operation, the speed is controlled by the converter [1,2,5,17,18]. There are several types of converters used in EVs, and some of these converter topologies are discussed below.

- i. Buck converter
- ii. Boost Converter
- iii. Buck-Boost Converter

2.1 Buck Converter

The buck converter is a type of DC-DC power converter that reduces the voltage of an input DC voltage to a lower output DC voltage. The buck converter consists of an input voltage source, a transistor, an inductor, a diode, and an output capacitor. During the ON state of the transistor, the inductor stores energy from the input voltage source. During the OFF state of the switch (transistor), the stored energy is released to the load through the diode. The output voltage of the buck converter can be controlled by adjusting the duty cycle of the transistor, which is the ratio of time the transistor is ON to the total switching period. Increasing the duty cycle decreases the output voltage, and the capacitor and inductor are used to reduce the ripple voltage [2,18,25].

2.2 Boost Converter

The boost converter circuit consists of an input voltage source, a transistor, an inductor, a diode, and an output capacitor. During the ON state of the transistor, the inductor stores energy from the input voltage source. During the OFF state of the transistor, the stored energy is released to the load through the diode. The output voltage of the boost converter can be controlled by adjusting the duty cycle of the switch (transistor), which is the ratio of the switch (transistor) ON time to the total switching period. Increasing the duty cycle increases the output voltage. The capacitor and inductor are used to reduce the ripple voltage [24].

2.3 Buck-Boost Converter

The Buck-Boost converter is a type of DC-DC power converter that can step up or step down the input voltage to a desired output voltage, depending on the duty cycle of the switch (transistor). It works by using a combination of buck and boost converter topologies. The buck-boost converter consists of an input voltage source, a transistor, an inductor, a diode, and an output capacitor. During the ON state of the transistor, the inductor stores energy from the input voltage source. During the OFF state of the transistor, the stored energy is released to the load through the diode, which prevents the inductor from discharging through the transistor. In the buck-boost converter, the output voltage can be either greater or less than the input voltage depending on the duty cycle of the switch (transistor). If the duty cycle is less than 50%, the output voltage is lower than the input voltage (buck operation), while if the duty cycle is greater than 50%, the output voltage is higher than the input voltage (boost operation). Capacitors and inductors are used as filters to reduce the ripple voltage [26].

These are the major converter topologies that are used in EVs. These power devices have high power ratings and performance. Through various analyses and research, the proposed DC-DC buck converter has been identified as an efficient, compact, and cost-effective solution for controlling the speed of e-vehicles.

3. PROPOSED EV CONTROLLER

3.1 Schematic discussion of the proposed EV Controller

The schematic diagram shown in **Figure-1** depicts the proposed EV controller's integration topology with its associated circuits to the PMDC motor. The Li-Ion battery with a capacity of 24V and 16Ah is the primary source of power that is connected to the voltage regulator. The voltage regulator is responsible for regulating the input DC voltage of 24V from the battery to 5V, which is required for the proper functioning of the throttle and gate driver circuits [16,20,21,22].

The throttle and gate driver circuits are interlinked with the voltage regulator, and they control the PMDC motor through the EV controller [3,7,13]. The gate driver circuit receives signals from the throttle,

which are varied by the acceleration of the vehicle. The overall circuit is interconnected to the E-Vehicle Controller, and the output is connected to the PMDC motor, which drives the vehicle.

Overall, the proposed schematic diagram of the EV controller integrates various circuits, including the voltage regulator, throttle, gate driver, and PMDC motor, to ensure the efficient functioning of the EV. The use of a Li-Ion battery and efficient voltage regulation makes the prop proposed EV controller a reliable and cost-effective solution for electric vehicles.

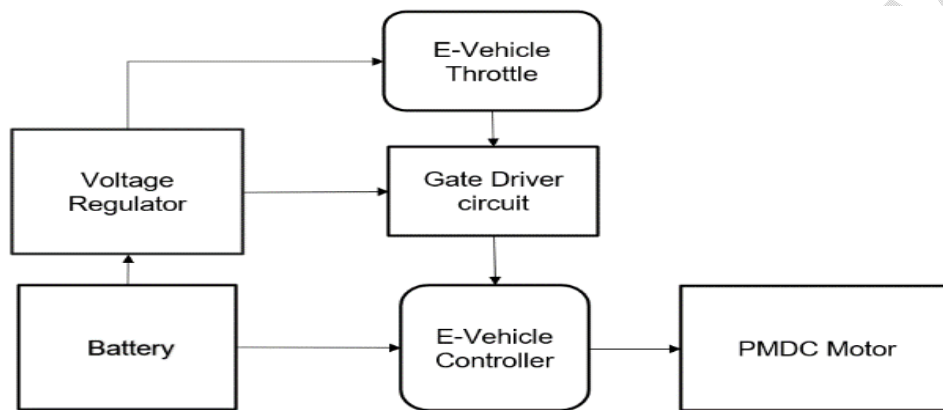

Figure-1: Schematic Diagram of E-Vehicle

3.2 Circuit Configuration

The proposed article consists of two main units: the controller unit and the gate driver unit, which are shown in Figure 2. The circuit configuration of the proposed DC-DC converter is based on a buck operation that varies from 0 to 24 V DC, depending on the duty cycle given to the switch (BJT). Variable frequency control is used in the switch to adjust the duty cycle, which can vary from 1 kHz to 3.7 kHz [2,18].

The operation of the driver circuit, which is designed for our controller, is the heart of the electric vehicle (EV). In this circuit, the battery is used as a power source, which is connected to the BJT acting as a switch to control the ON and OFF conditions. PWM pulses [11] are generated at a certain frequency to control the motor to the required speed. Two diodes are used for two different conditions: one for the freewheeling action of the DC motor, and the other to resist back current from the load to the source. The input capacitor is used to reduce jerk in the EV during starting, and the output capacitor is used to reduce ripple voltage to the load.

3.3 Gate Driver Circuit

The gate driver circuit is designed to provide proper supply to the driver circuit. The circuit shown in Figure 3 uses important components such as 555 timers, voltage regulators, RC combinations, Zener

diodes, LEDs (indicators), etc. This circuit has three terminals: two inputs and one output. The two inputs are the throttle and the battery, and the output is a PWM signal.

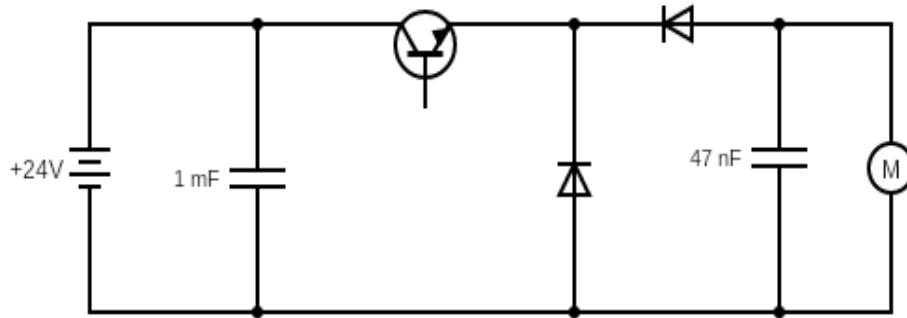

Figure-2: Circuit Diagram of the DC-DC converter

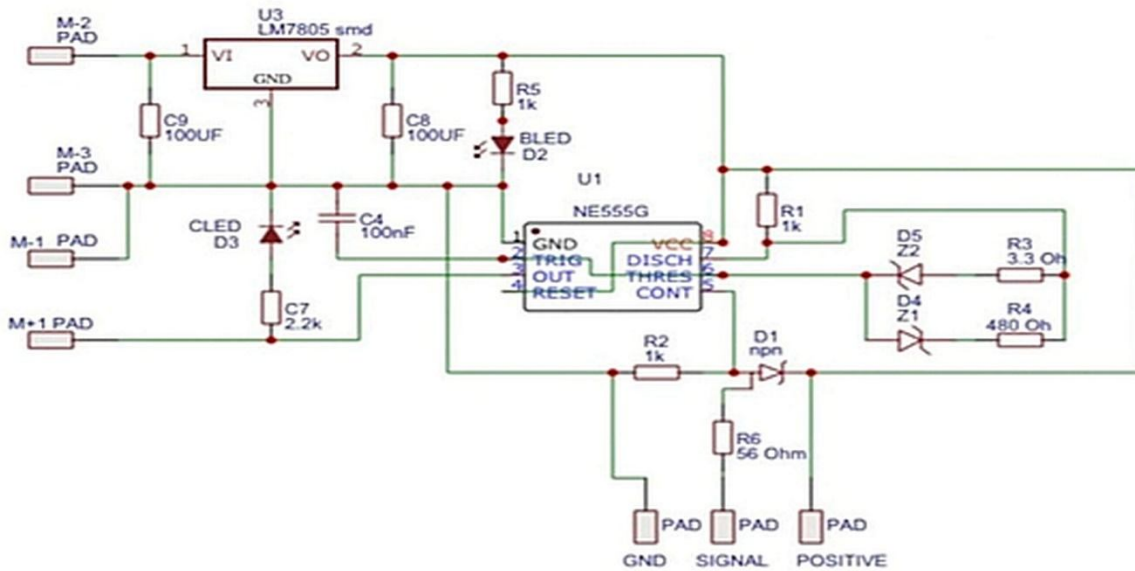

Figure-3: Gate Driver Circuit

The Li-Ion battery is the source that supplies 24V [15], and the throttle is used to control the PWM signal. A voltage regulator is a system designed to maintain a constant voltage of 5V DC. Electronic voltage regulators are commonly found in devices such as processors where they stabilize the DC voltages. In this circuit, the voltage regulator is used to control the voltage level.

The whole circuit operates under the control of 555 timer controllers. The 555 Timer is commonly used to produce different output waveforms with the help of an external RC network. The 555 timer IC is a useful precision timing device that can act as either a simple timer to generate single pulses or long-time delays or as a relaxation oscillator producing a string of stabilized pulses. A PWM pulse is generated by the 555 timer IC and the circuits of the RC combination in the circuit. The PWM pulse is generated based on the throttle acceleration given to the driver. This PWM pulse is then given to the base terminal of the switching device (BJT).

4. DESIGN AND SPECIFICATIONS OF CONVERTER

The design specifications of the proposed converter are discussed by using the following equations, the equation to find duty cycle D [23].

$$D = \frac{V_{out}}{V_{in}} \text{ --- (1)}$$

Where,

D - Duty Cycle

V_{out} - Output Voltage

V_{in} - Battery Voltage

The equation to determine the capacitor C_1 is

$$C_1 = \frac{I_o}{f \times \Delta V_o} \text{ --- (2)}$$

$$C_1 = 4700 \mu F \text{ --- (3)}$$

Where,

C_1 = Output Capacitor

I_o = Output Current

f = Switching Frequency

ΔV_o = Output Ripple Voltage

Table: 1 EV controller parameters

Parameters	Rating
Supply voltage of the battery(V)	24 V
Capacitor(C_1)	4700 μF
Capacitor(C_2)	1mF
Output power (P_o)	250 W
Output voltage (V_o)	0-24 V
Output current (I_o)	10.4 A
Switching frequency	3.7 kHz
Voltage of PMDC Motor	24 V, 250W

The above equations were used to design the proposed converter [23]. The designed parameters and values for the converter are tabulated in Table 1. These parameters and values were chosen to meet the design specifications of the converter, which include a power rating of 250W, a voltage range of 0-24V, a current rating of 10.4A, and a switching frequency of 3.7kHz.

5. EV CONTROLLER PERFORMANCE ANALYSIS UNDER VARIOUS OPERATING CONDITIONS

RC refers to the combination of an external resistor and capacitor that is connected to the 555-timer circuit [27]. This combination allows for the switching frequency and no-load current given to the driver circuit to be varied. If the capacitance value is kept constant and the resistance value increases, the current gradually increases while the switching frequency decreases. This analysis is shown in Table 1. Some equations are depicted for example.

If resistance,

$$R=1 \text{ K}\Omega$$

Then switching frequency varies between,

$$F=10.5 \text{ kHz} - 300 \text{ Hz}$$

Then Current,

$$I=0.86 \text{ A}$$

If resistance,

$$R=5.5 \text{ K}\Omega$$

Then switching frequency varies between,

$$F=6.9 \text{ kHz} - 1 \text{ kHz}$$

Then Current,

$$I=0.92 \text{ A}$$

Table 2 shows the results when the resistance is kept constant at 10k ohm and the capacitance value is decreased, resulting in an increase in switching frequency. For instance, when the capacitance value is 100nF and the resistance is 10k ohm, the frequency value ranges from 300 Hz to 3.95 KHz. Similarly, when the capacitance value is 25nF and the resistance remains the same, the frequency value ranges from 1.2 KHz to 5.1 KHz. However, when the capacitance value is held constant and the resistance value increases, the current also increases gradually while the switching frequency decreases.

Table: 2 Switching frequency analysis under variation of capacitance

Capacitance (nF)	Resistance (kΩ)	Frequency (min.)	Frequency (max.)
100	10	300Hz	3.95 KHz
50	10	600Hz	4.1 KHz
33.3	10	900Hz	4.32 KHz
25	10	1.2 KHz	5.1 KHz

Table: 3 Switching frequency analysis under Variation of Resistance

Capacitance (nF)	Resistance (kΩ)	No-Load Current (A)	Frequency (min.) (KHz)	Frequency (max.) (KHz)
25	1	0.86	0.3	10.5

25	2	0.92	0.6	9.5
25	3	0.94	0.9	8.5
25	4.3	0.96	0.95	7.5
25	5.5	1	1	6.9
25	7.5	1.05	1.1	5.9

Switching frequency analysis based on the variation of resistance and capacitance as constant are tabulated in Table-3. The switching frequency is varied based on this variation. This gives us the study and the importance of choosing the correct and accurate value of capacitance and resistance.

6. RESULTS AND DISCUSSION

6.1. Simulation results

The circuit diagram of the converter was simulated in MATLAB/Simulink, as shown in Figure 4. The converter was then tested under various conditions, and the resulting waveforms were analyzed [24,25,26]. The waveforms obtained under each condition are listed below.

Open loop simulation of DC-DC converter

The open-loop simulation of the E-vehicle converter is simulated. The waveforms of the below circuit at different parameters are discussed below.

The open loop simulation diagram of the E-Vehicle converter is shown in Figure-4. By using the pulse generator, the gate pulse is given to the switch (MOSFET or BJT) of the proposed converter. In real-time, the pulse is given by the gate driver circuit. The duty cycle of the switch controls the output voltage. By varying the duty cycle, the output voltage can be varied.

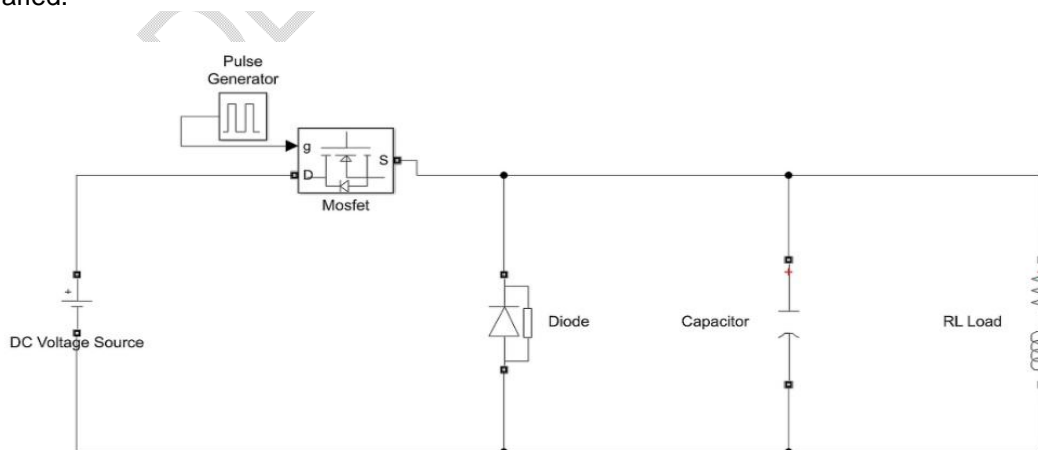

Figure-4: MATLAB/Simulink Circuit Diagram of the converter

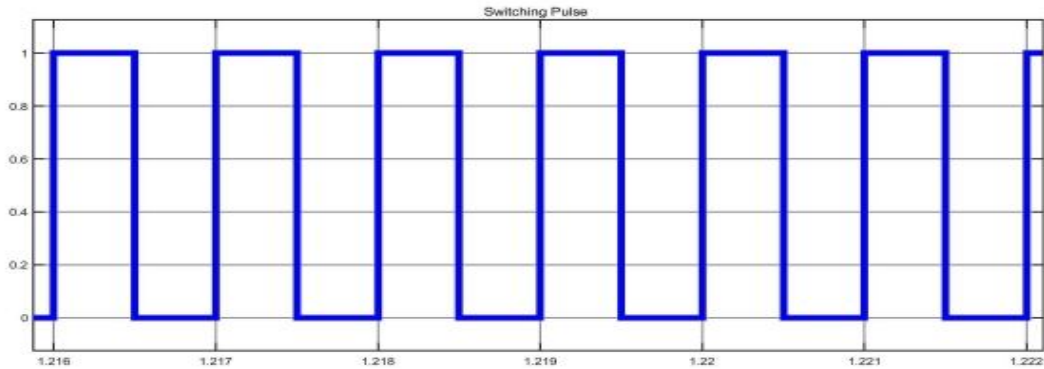

Figure-5: Switching Pulse Waveform of the Converter

The switching pulse waveform of the proposed DC-DC converter is generated by a pulse generator, as shown in Figure-5. The switching frequency (f_s) is 3.7 kHz, which is the maximum frequency generated by the gate driver circuit. The duty cycle is determined by this pulse generator.

The output voltage waveform of the proposed DC-DC converter under open loop conditions is shown in Figure-6. The output voltage can be varied between 0 and 24V, depending on the duty cycle applied to the converter switch. Figure-7 shows the output current waveform of the proposed DC-DC converter under open loop conditions.

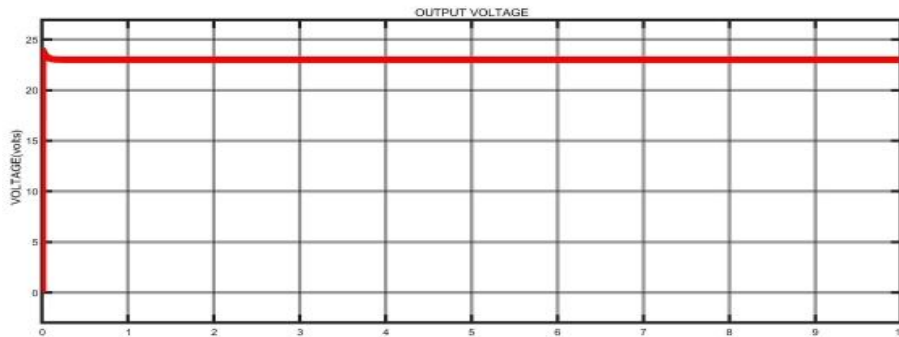

Figure-6: Output voltage waveform under open loop condition of the converter

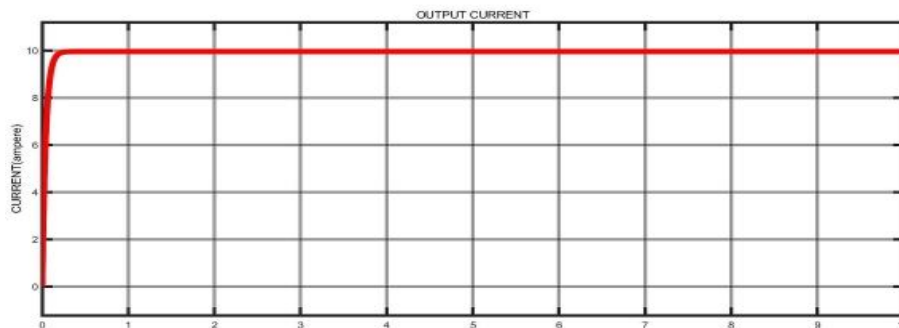

Figure-7: Output Current Waveform under open loop condition of the converter

Table: 4 Constant Input Voltage vs Variable Output Voltage of the converter

V_{in} (V)	I_{in} (A)	V_{out} (V)	I_{out} (A)	Duty Cycle	Efficiency
24	9.958	23	9.958	0.9583	95.85%
24	9.324	22	9.545	0.9166	91.69%
24	8.38	20	8.729	0.8333	84.36%
24	7.71	18	7.94	0.75	75.01%
24	6.939	16	7.015	0.6666	67.48%
24	6.169	14	6.236	0.5833	60.14%
24	5.238	12	5.295	0.5	51.10%

The above Table 4 gives the analysis of constant input voltage and variable output voltage. The input voltage is kept constant while the output voltage is varied using the Buck converter, resulting in the expected output voltages. As the output reference voltage is increased, the input current also increases. From the data in the table, the output voltage can be varied from 0 to 24V. The efficiency of the Buck converter varies from 95.85% to 51.10%.

The efficiency calculation is discussed below,

$$\text{Efficiency} = \frac{\text{Output Power}}{\text{Input Power}} \text{ --- (4)}$$

For example,

$$\text{Power} = VI \text{ --- (5)}$$

If, $V_{in} = 24$, $I_{in} = 9.958$, and
 $V_{out} = 23$, $I_{out} = 9.958$

Then the output power and input power for the above values are,

$$\text{Output power} = 229.034 \text{ ----- (6)}$$

$$\text{Input power} = 238.992 \text{ ----- (7)}$$

Then the Efficiency is calculated,

$$\text{Efficiency} = \frac{229.034}{238.992} \text{ ----- (8)}$$

$$\text{Efficiency} = 0.95833 \times 100 \text{ ----- (9)}$$

$$\text{Efficiency} = 95.85\%$$

By this above calculation the efficiency is calculated [23].

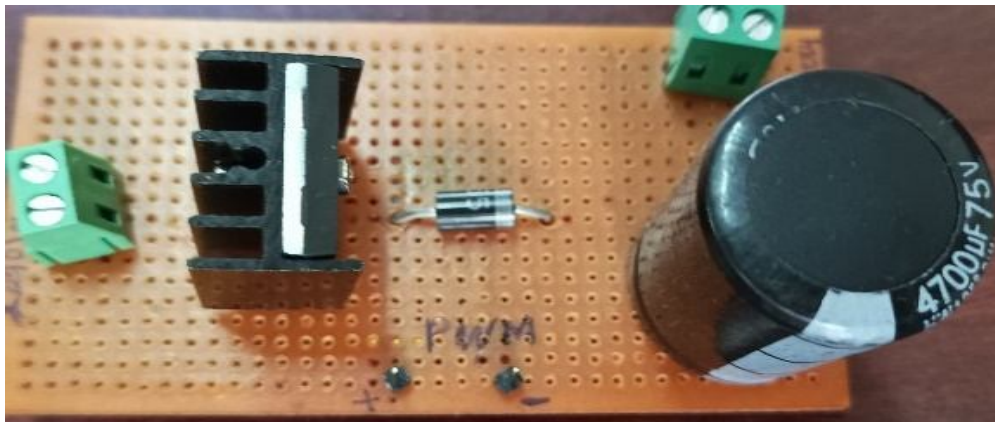

Figure-8: Controller Kit

6.2. Hardware Results

There are two main Hardware circuits for this proposed article one is the Controller circuit and the other is the gate driver circuit. These two circuits are discussed below.

6.2.1. Controller Kit

The controller is a major component of an electric vehicle, and the proposed controller circuit is illustrated in [Figure 8](#). The controller kit is used to regulate the speed of the PMDC motor and comprises a BJT (transistor) switch, diode, capacitor, input and output DC terminal.

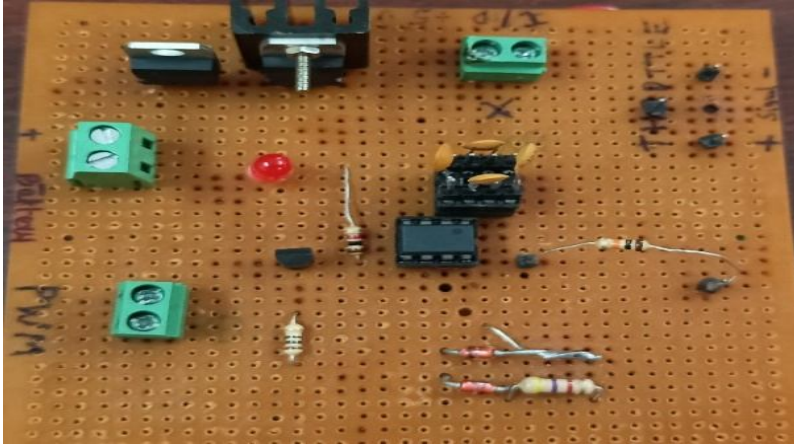

Figure-9: Gate Driver Circuit

The input DC terminal of the controller is connected to a 24V, 16Ah Li-Ion Battery, and the output DC terminal is connected to a 250W, 24V PMDC motor.

6.2.2. Gate Driver Kit

The gate driver kit that is shown in **Figure 9**, which gives the PWM signal to the controller kit, and by using this the PMDC motor is controlled. The output terminal of the PWM signal from the gate driver circuit kit is connected to the base and emitter terminals in the BJT transistor which is in the controller kit. Here the 24V supply is given by the battery and the throttle is used to control the PWM signal.

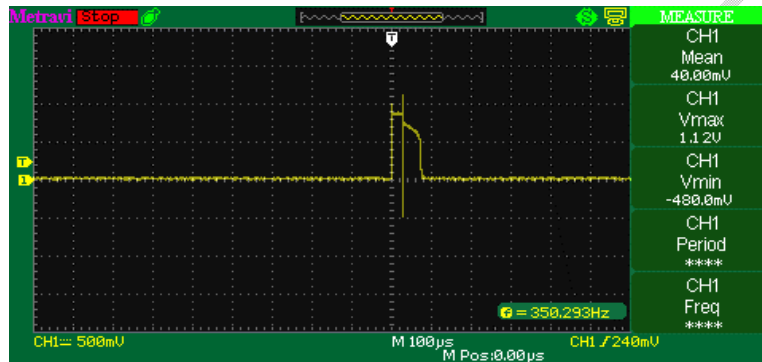

Figure-10: Experimental set-up of proposed EV controller

6.2.3. Experimental set-up

The experimental analysis and set-up of E-Vehicle controller is depicted in **Figure 10**. The set-up consists of gate driver circuit, controller circuit, battery and Digital Storage Oscilloscope. With this analysis the waveforms have taken under various condition such as zero acceleration, and maximum acceleration, also analyzed speed-torque characteristics under load conditions.

6.3. Waveform Analysis

Various waveforms were analyzed using the controller and gate driver circuit kit, with different parameters. **Figure-11** shows a graphical

representation of the PWM signal given to the switch at zero acceleration under no-load condition, with a frequency of 350.293Hz and a PWM voltage of 1V. This graph was captured using a digital storage oscilloscope (DSO), and the PWM signal was taken as output from the gate driver circuit, which was given to the base and emitter pins in the switch.

The graphical representation of the PWM signal is depicted below in **Figure-11** which is given to the switch at maximum acceleration at no-load condition, where the frequency is low at 3.7KHz and the PWM voltage is 1V.

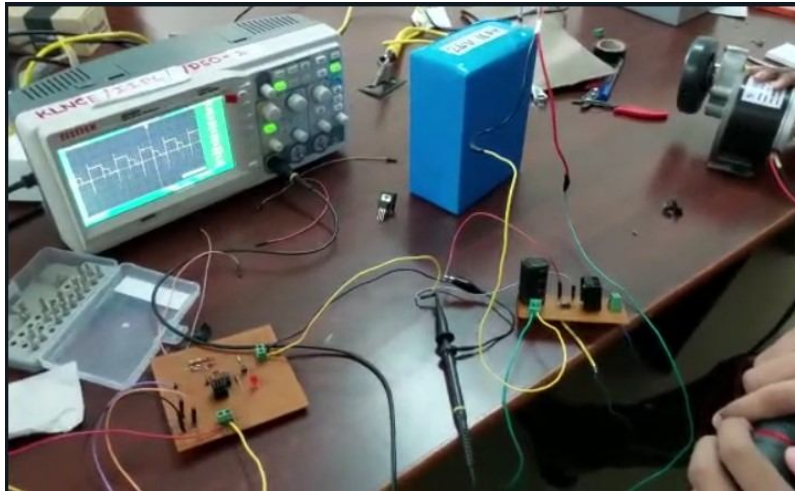

Figure-11: PWM signal at zero acceleration

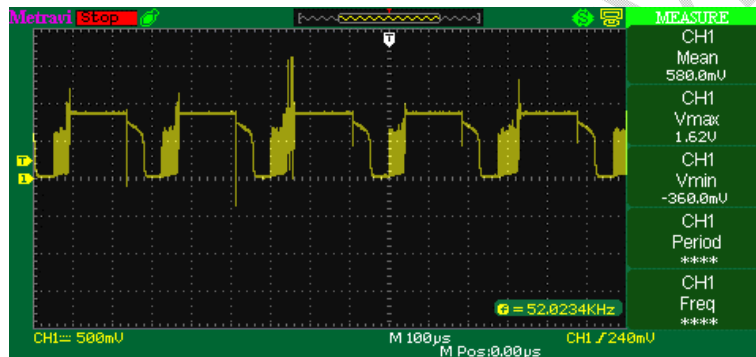

Figure-12: PWM signal at maximum acceleration

6.4. EV Motor Speed-Torque Characteristics of PMDC Motor

Speed-Torque characteristics of the motor are analyzed under conditions such as No-load and load conditions.

In No-load condition, the speed of the motor is increased, then the torque is

increased simultaneously is depicted in **Figure 13**.

In load condition, the speed of the motor decreases, when the load increases, then the torque decreases, which is shown in **Figure 14**.

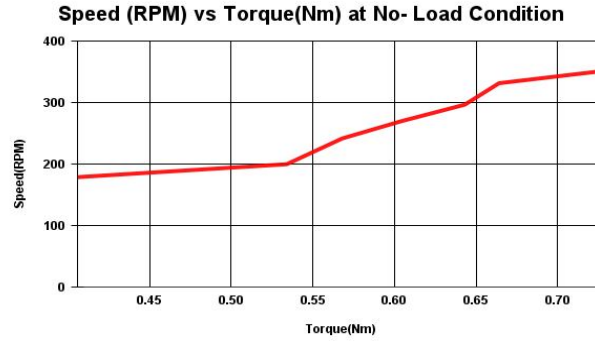

Figure-13: EV motor Speed-Torque characteristics under No-load conditions

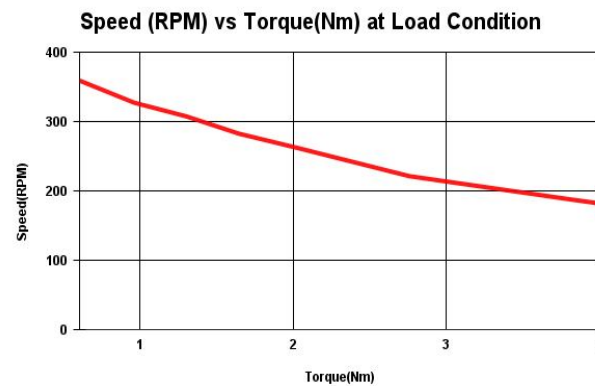

Figure-14: EV Motor Speed-Torque characteristics under Load Conditions

7. CONCLUSION

This research article has discussed the design and implementation of an optimized controller for E-Vehicles. The controller is comprised of a compact gate driver circuit and controller, battery, and a PMDC motor fitted to the rear axle of the E-Vehicle. EV controller parameters are designed based on the specifications of EV battery and motor. The EV controller performance has analyzed under various switching frequency and the corresponding efficiency of the controller has derived under different duty cycle of the EV controller. The Speed-Torque Characteristics of the Motor is analyzed under no-load and load conditions. The simulation, Realtime testing and validation results of the proposed controller has discussed in the research article.

REFERENCES

- [1] J Rekha, T M. Thamizh Thendral, K Vijayakumar "Electric Vehicle Motor, Converter, Controller and Charging Station with Challenges and Configurations: Review" International Journal of Renewable Energy Research Vol.12, No.1, March 2022.

- [2] Manoharan Premkumar, Umashankar Subramaniam, Hassan Haes Alhelou and Pierluigi Siano "Design and Development of Non-Isolated Modified SEPIC DC-DC Converter Topology for High-Step-Up" *Energies* 2020, 13, 3960.
- [3] Mehmet Fatih CANKURTARAN, Ali Eren KOCAMIS "Sensorless Speed Control of PMDC Motor with Cascade PI Controller" 61st International Symposium ELMAR-2019, 23-25 September 2019, Zadar, Croatia.
- [4] Pritam Keshavdas "Emission Reduction by Conversion of Bicycle to Plug-In Hybrid Electric Bicycle for Low Distance Commuter as Replacement of Motorized Two Wheelers" The XI International Symposium on Advanced Topics in Electrical Engineering March 28-30, 2019.
- [5] H. Suryoatmojo, I. Dilianto, Suwito R., Mardiyanto, E Setijadi, D.C. Riawan "Design and Analysis of High Gain Modified SEPIC Converter for Photovoltaic Applications" 2018 IEEE International Conference on Innovative Research and Development (ICIRD).
- [6] Neha Adhikari, Bhim Singh "Performance evaluation of a low power solar - PV energy system with SEPIC Converter" 2011 IEEE Ninth International Conference on Power Electronics and Drive Systems.
- [7] Angalaeswari. S, Amit Kumar, Divyanshu Kumar, Shubham Bhadoriya "Speed Control of Permanent Magnet (PM)DC Motor Using Arduino and LabVIEW" 2016 IEEE International Conference on Computational Intelligence and Computing Research.
- [8] Chyi-Ren Dow, Shun-Ming Chang, Van-Tung Bui and Pei Liu "A Vibration Reduction System for E-bikes" 21 June 2020 *Energies* journal.
- [9] Zhu Deyi¹, Zhang Kai¹, Yin Dejun¹, "A New Torque Control Approach for Electric Power Assisted Bicycle Based on Model-Following Control" e 2017 IEEE International Conference on Information, Communication and Engineering.
- [10] P. Giani, M. Tanelli and S. M. Savaresi "Identification and control of a continuously variable transmission for bicycles".
- [11] George K. Kostopoulos "Design and Analysis Nomograms for Pulse-Width and Frequency Modulation Using the 555 Timer" 1984 IEEE.
- [12] Jianing Lin, Senior Member, IEEE, Nigel Schofield, "External-Rotor 6–10 Switched Reluctance Motor for an Electric Bicycle" *IEEE Transactions on Transportation Electrification*, Vol. 1, No. 4, December 2015.
- [13] Upasana Sarma, Prof. P.K Bordoloi "Speed Control of A DC Motor Using PLC and PIC Microcontroller" 2017
- [14] M.M. Morcos, Curtis R. Mersman, G.D. Sugavanam, Norman G. Dillman Battery Chargers for Electric Vehicles *IEEE Power Engineering Review*, November 2000.
- [15] M. Senthilkumar K.P.Suresh T.Guna Sekar C. Pazhani Muthu, Efficient Battery Monitoring System for E-Vehicles. 021 7th International Conference on Advanced Computing & Communication Systems (ICACCS).

- [16] Wang Menghua, Xiao Bing A Real-time Android-based Monitoring System for the Power Lithium-ion Battery Used on EVs 2017 10th International Conference on Intelligent Computation Technology and Automation.
- [17] Sayed Mahmud, Anika Bushra, Tamanna Sumaiya, Hossain Md Arafat, Rahman Md Ashiqur Study of AC to DC Converter.
- [18] Jameel Kadhim Abed Smart Monitoring System of DC-to-DC converter for Photovoltaic Application International Journal of Power Electronics and Drive System (IJPEDS).
- [19] R Thanga Sankaran, Dr. S Parthasarathy, S Shanthini " Design and Analysis of AC-DC Interleaved Negative Output CUK Converter for Power Quality Enhancement " Innovative trends in future Engineering and technology 2019.
- [20] Dimas Anton Asfani, Yulistya Negara, Gusti Ngurah Satriyadi Hernanda, Daniar Fahmi, Muhammad Nur Yuniarto, Rizal Hardiyanto, Raditya Premananda Real-Time Battery Monitoring and Fault Identification Application on Electric Scooter 2019 International Seminar on Application for Technology of Information and Communication.
- [21] Swapnil P. Karmore, Anjali R. Mahajan, Suruchi Kitey Battery monitoring and analysis for Android based system 2013 IEEE.
- [22] Safy Saeeda, SK. A. Shezanb , M.I. Arbabc , Sohel Ranad. Battery Monitoring System for the smart grid applications. Australasian Universities Power Engineering Conference (AUPEC) 2017.
- [23] Mr.R.Thangasankaran, Dr.S.Parthasarathy, Mr.P.G.Harish Prabu, Mr.R.Praveen Thiyagarajan, Mr.R.Arun Kumar "MATLAB/Simulink analysis of a ripple-free high-efficiency buck-boost type converter for EV charging and controlling applications" International Research Journal of Engineering and Technology Volume: 09 Issue: 06, Jun 2022.
- [24] M. Veerachary "Design and Analysis of a New Quadratic Boost Converter" 2017 National Power Electronics Conference (NPEC) College of Engineering Pune, India. Dec 18-20, 2017.
- [25] Ms. K Swathy, Ms. Shrutika Jantre, Ms. Yogita Jadhav, Mr. Sushil M. Labde, Mr. Pratik Kadam "Design and Hardware Implementation of Closed Loop Buck Converter Using Fuzzy Logic Controller" Proceedings of the 2nd International conference on Electronics, Communication and Aerospace Technology (ICECA 2018) IEEE Conference Record # 42487; IEEE Xplore ISBN:978-1-5386-0965-1.
- [26] Mummadi Veerachary "Design and Analysis of Split-inductor Based Buck-Boost Converters" 978-1-7281-0397-6/19/2019 IEEE.

[27] Norman Mariun, Senior Member, IEEE Ishak Aris "Simple Boost Converter using Timer IC 555 for Charging Capacitor Banks" IEEE Student Conference on Research and Development 2010.

[28] Lorenzo Stilo, Heinz Lugo, Diana Segura Velandia, Paul P. Conway, and Andrew A "Personalised Controller Strategies for Next Generation Intelligent Adaptive Electric Bicycles" IEEE transactions on intelligent transportation systems 2022.

UNDER PEER REVIEW