

Original Research Article

Development and ergonomic assessment of manually operated modified linseed crop thresher for studying the physical properties of the linseed seed

ABSTRACT

Studying the physical properties of linseed were studied for two varieties SHUATS Alsi-2 and Neelam, with moisture contents (d.b) of 7.473%, 10.786%, and 14.03%. The average number of capsules per plant was found to be 36.88. The average number of seeds per capsule was found to be 8.12. Linseed's length, width, and thickness were measured to be 8.11, 6.94, and 6.87 mm, respectively. The geometric mean diameter was measured at 7.288 mm. The linear dimensions of the seed were discovered to be an average of 5.308mm, width 2.507mm, and thickness 0.964mm for the SHUATS Alsi-2 variety, and an average of 5.214mm, width 2.448mm, and thickness 0.903 for the Neelam variety. The SHUATS Alsi-2 variety had an average AMD of 2.924mm and a GMD of 2.338mm, whereas the Neelam variety had an average AMD of 2.855mm and a GMD of 2.258mm. The average surface area, sphericity, and volume for the SHUATS Alsi-2 variety were 17.218mm², 0.441, and 6.741mm³, respectively, whereas the average surface area, sphericity, and volume for the Neelam variety were 16.0403mm², 0.433, and 6.047mm³. It was also discovered that the mean 7.656gram 1000 grain weight for the linseed variety in SHUATS Alsi-2 and the mean 8.0153gram 1000 grain weight for the linseed variety in Neelam were different. The SHUATS Alsi-2 variety had an average bulk density of 626.64 kg/m³, a true density of 1139.553 kg/m³, and a porosity of 44.847, whereas the Neelam variety had an average bulk density of 673.354 kg/m³, a true density of 1126.174 kg/m³, and a porosity of 40.135.

Keywords: Linseed, capsules, Moisture content, Linear dimensions, Density

1. Introduction

Linseed (*Linum usitatissimum* L.) belongs to the genus *Linum* and the family *Linaceae*. *Jawas* and *Alsi* are the local names for it. In central India, it is a prominent oilseed crop. Linseed is regarded as one of the most important commercial yarn crops. Linseed blossoms contain a cluster of five pale blue petals. The fruit is made up of spherical capsules. The seeds are round, somewhat flattened, pale to dark brown, and lustrous. Linseed is produced for both seed and fibre production. Fabric, dye, paper, lubrication, soap, fishing nets, and medicines are all made from the linseed plant. It is one of the oldest crops grown by humans for grain and fibre. It has been cultivated since antiquity for the production of flax (fibre) and seeds. Every part of the linseed plant is economically used, either directly or indirectly. Linseed has received a lot of attention in recent years because of its nutritional content, which has a positive effect on disease prevention by providing health-promoting

Comment [h1]: *Linum usitatissimum*

components such as alfa linolenic acid, lignin, and polysaccharides; essential amino acids, carbohydrates, vitamins, minerals, crude fibre, and this is the best herbal source of omega-3 and omega-6 fatty acids. Diets high in fibre have been shown to reduce the risk of heart disease, diabetes, colorectal cancer, obesity, and inflammation (Temelli and Bozan [2008]). It has happened. Linseed has the highest concentration of the omega-3 fatty acid alpha-linolenic acid of any oilseed crop. Kazakhstan, Russia, Canada, China, the United States of America, India, Ethiopia, Afghanistan, France, and the United Kingdom of Great Britain are the top ten linseed producing countries in 2019. In 2019, India is ranked sixth among linseed producing countries. Major linseed producing states in the country include Madhya Pradesh, Karnataka, Chhattisgarh, Jharkhand, Bihar, Maharashtra, Odisha, Uttar Pradesh, West Bengal, and Assam. Madhya Pradesh and Uttar Pradesh jointly produce around 70% of the national linseed production. Threshing of the linseed crop involves physical beating and animal trampling of harvesting plants.

- Comment [h2]: fiber
- Comment [h3]: fiber
- Comment [h4]: ,2008
- Comment [h5]: Bozon and Temelli, 2008
- Comment [h6]: ,2008
- Comment [h7]: Line?
- Comment [h8]: -

2. Materials and Methods

The SOLIDWORKS drawing of a linseed crop thresher was generated. The modified linseed crop thresher was created at the Farm Machinery and Power Engineering workshop at VIAET, SHUATS Prayagraj.

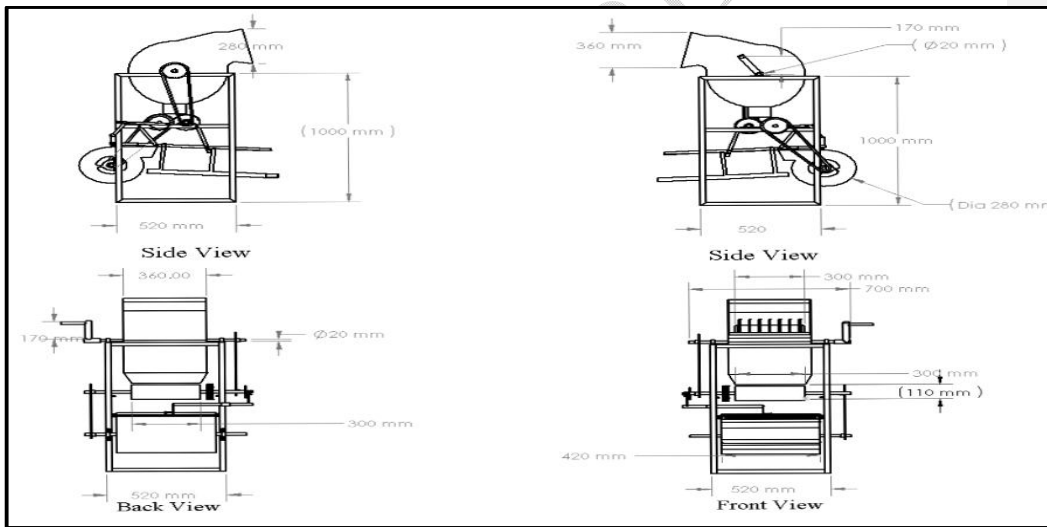

Fig.1 Overall dimension of manually operated modified linseed crop thresher

Linseed was physically cleaned to remove any foreign contaminants such as dust, dirt, broken or immature seeds. The original moisture content of the seeds was evaluated by drying them in a hot air oven at 1051 °C for 24 hours. Using the usual hot air oven method and the following calculation, the initial moisture content of seed was measured (AACC, 1995).

$$MC (\%) = \frac{W_2 - W_3}{W_3 - W_1} \times 100$$

- Comment [h9]: Of the
- Comment [h10]: Year is different in ref.

Where, MC is the Moisture content on dry basis, %; W_1 is the initial weight of the bowl in grams; W_2 is the sample weight before drying + bowl weight in grams; W_3 is the sample weight after drying + bowl weight in grams.

Comment [h11]: On a

Using the following equation and careful mixing, Sacilink et al. (2002) made seed samples with the right amount of moisture by adding the amount of distilled water that was calculated and mixing them well.

$$Q = \frac{m_f - m_i}{100 - m_f} \times w_i$$

Where Q is the weight of the water to be added in grams, w_i is the initial weight of the seed sample in grams, m_i is the initial moisture content of the seed sample in percentages dry basis, and m_f is the final moisture content of the seed sample in percentages dry basis.

Comment [h12]: On not in



Fig.2 Physical properties in laboratory testing

2.1 Linear seed dimension

To figure out the size and shape of the linseed, the length, width, and thickness of 50 randomly chosen seeds from each variety were measured with a digital Vernier Calliper that had a minimum count of 0.01 mm. The average of these measurements was then written down.

$$AMD = \frac{L+B+T}{3}$$

$$GMD = (LBT)^{1/3}$$

where AMD is the arithmetic mean diameter (mm), GMD is the geometric mean diameter (mm), L is the length (mm), B is the breadth of the seed (mm), and T is the thickness of the seed (mm).

2.2 Surface area

The surface area (S) was determined using the expression (Singh et al., 2010).

$$S = \pi(GMD)^2$$

2.3 Sphericity

Sphericity is defined as the ratio of the surface area of a sphere with the same volume as the grain to the surface area of the grain, and it was calculated using the formula below (Mohsenin, 1986). It is symbolised by the 'φ'.

$$\phi = \frac{(LBT)^{1/3}}{L}$$

Comment [h13]: symbolized

2.4 Volume

The volume of the grain was calculated by taking the dimensions of the seed along three axes: length, breadth, and thickness, and then estimating volume using Mohsenin's relationship (1986). It is represented by the letter 'V'.

$$V(\text{mm}^3) = \frac{\pi LBT}{6}$$

2.5 Thousand grain weight

A total of 1,000 randomly selected grains from varying moisture levels were collected and weighed on a digital scale with a minimum count of 0.01 g. This magnitude is known as the grain's thousand-grain weight. The average of five replications was taken into account and given as a sample weight of 1000 grains.

2.6 Bulk density

The bulk density of a seed is the mass to total volume ratio. It was determined using the conventional test weight process, which consisted of filling a 250 ml graduated cylinder with a height of 12.5 inches, striking the top level, and weighing the contents (IS:4333 part III). Bulk density was then estimated as the ratio of the weight of the kernels to the volume of the cylinder (Akaaimo and Raji, 2006; Mwithiga and Sifuna, 2006).

$$BD = \frac{W_s}{V_s}$$

where BD = bulk density in kg/m³, W_s = sample weight in kg, and V_s = sample volume in m³.

2.7 True density

The toluene (C7H8) displacement method was used to determine the real density, which is defined as the ratio of the sample's mass to its true volume. Toluene was used instead of water since it is less absorbed by seedlings. Toluene (20 ml) was poured into a 40 ml graduated measuring cylinder, and 25 g of seeds were immersed in the toluene (Mwithiga and Sifuna, 2006; Ovelade et al., 2005). The amount of displaced toluene was measured using the cylinder's graduated scale. To figure out the real density, the weight of the seeds was divided by the amount of toluene that was moved.

T_{vs} = (initial toluene level in graduated cylinder) – (final moisture level in graduated cylinder)

$$TD = \frac{W_s}{T_{vs}}$$

Where TD represents true density in kg/m³, W_s represents seed weight in kg, and T_{vs} represents seed volume in m³.

Comment [h14]: in the

Comment [h15]: not italic line

2.8 Porosity

The porosity is the fraction of the bulk grain space that is not occupied by the grain. Using the equation, the porosity of the bulk seed was estimated using the actual density and bulk density

measurements.

$$\epsilon = \frac{TD - BD}{TD} \times 100$$

Where, ϵ is the porosity; TD is the true density, kg/m³; and BD is the bulk density, kg/m³.

3.Result and Discussion

3.1 Physical properties of linseed capsule

The physical properties of a linseed capsule include the number of capsules per plant, the number of seeds per capsule, the length, width, and thickness of the capsule, and the geometric mean diameter (GMD). The physical properties of linseed capsules are shown in Table 1.

Particular	Max.	Min.	Mean	SD (σ)	CV (%)
No. of linseed capsule per plant	41	30	36.88	2.619	7.101
No. of seed per capsule	10	6	8.12	1.129	13.914
Length of capsule (mm)	8.96	7.35	8.11	0.467	5.761
Width of capsule (mm)	7.79	6.05	6.946	0.440	6.346
Thickness of capsule (mm)	7.76	6.01	6.874	0.439	6.360
GMD (mm)	8.087	6.501	7.288	0.438	6.002

Table 1: Physical properties of linseed capsules (N = 25)

The average number of capsules per plant was found to be 36.88. The average number of seeds per capsule was found to be 8.12. Linseed's length, width, and thickness were measured to be 8.11, 6.94, and 6.87 mm, respectively. The geometric mean diameter measured 7.288 mm. There are no significant differences between the samples. Maurya et al. (2017) discovered a similar type of observation.

3.2 Moisture content's effect on linear dimensions of linseed varieties

The linear dimensions (length, breadth, and thickness) and AMD and GMD of two linseed seed varieties (Neelam and SHUATS Alsi-2) were determined within the moisture content ranges of 7.47%, 10.78%, and 14.03%. Figures 3 and 4 are provided.

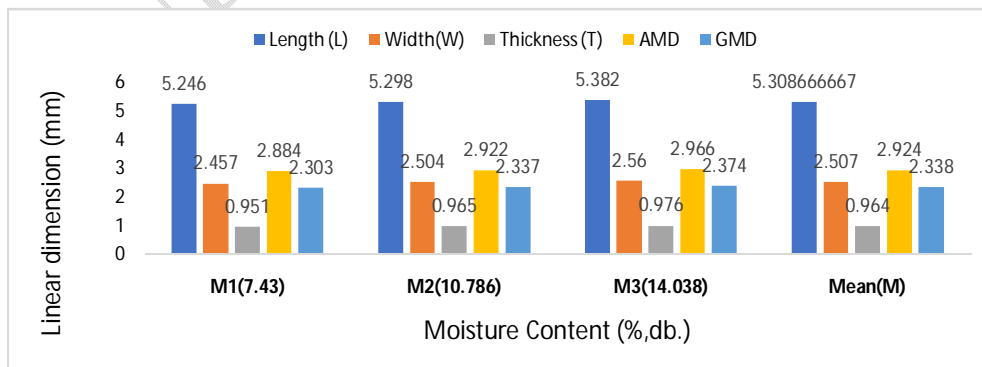

Fig.3 Moisture content's effect on linear dimensions of linseed variety in SHUATS Alsi-2

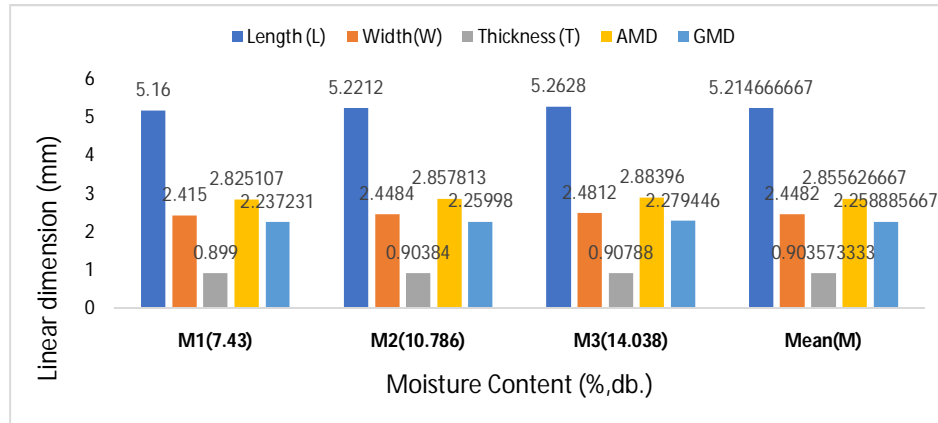

Fig.4 Moisture content's effect on linear dimensions of linseed variety in Neelam

The SHUATS Alsi-2 variety had an average length of 5.308mm, a width of 2.507mm, and a thickness of 0.964mm, whereas the Neelam variety had an average length of 5.214mm, a width of 2.448mm, and a thickness of 0.903. The SHUATS Alsi-2 variety had an average AMD of 2.924mm and a GMD of 2.338mm, whereas the Neelam variety had an average AMD of 2.855mm and a GMD of 2.258mm. Wang et al. (2007) and Bhishe et al. (2013) also found that the linear dimension and average diameter of linseed increase as the amount of moisture in the seed increases.

3.3 Moisture content's effect on surface area, sphericity, volume and 1000 grain weight of linseed varieties

The surface area, sphericity, volume, and 1000 grain weight of two linseed seed varieties, Neelam and SHUATS Alsi-2, were determined within the moisture content ranges of 7.47%, 10.78%, and 14.03%. It is located between figures 5 and 6.

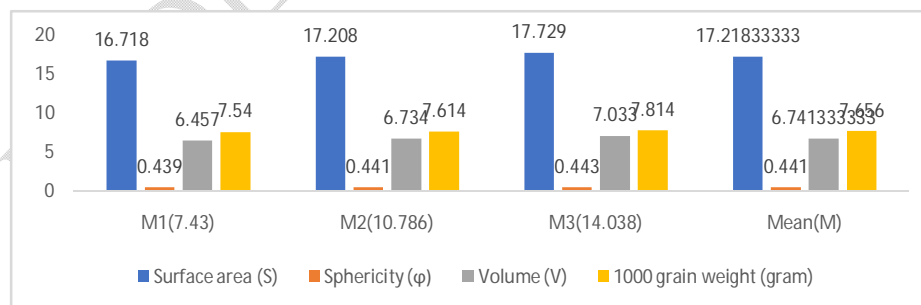

Fig.5 Moisture content's effect on surface area, sphericity, volume and 1000 grain weight of linseed variety in SHUATS Alsi-2

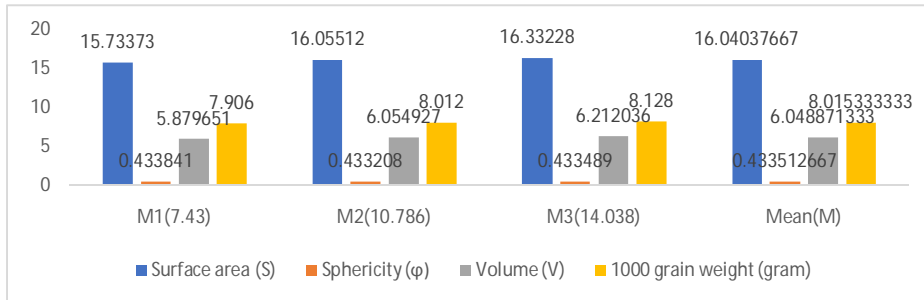

Fig.6 Moisture content's effect on surface area, sphericity, volume and 1000 grain weight of linseed variety in Neelam

The average surface area, sphericity, and volume for the SHUATS Alsi-2 variety were 17.218mm², 0.441, and 6.741mm³, respectively, whereas the average surface area, sphericity, and volume for the Neelam variety were 16.0403mm², 0.433, and 6.047mm³. It was also discovered that the mean 7.656gram thousand grain weight for the linseed variety in SHUATS Alsi-2 was lower than the mean 8.0153gram thousand grain weight for the linseed variety in Neelam. The observation of an increase in these linseed properties as moisture content increases agrees with the findings reported by Coskuner and Karbaba (2007), Bhishe et al. (2013), and Wang et al. (2007).

Comment [h16]: (2007)

3.4 Moisture content's effect on bulk density, true density and porosity of linseed varieties

The bulk density, true density, and porosity of two linseed seed varieties, SHUATS ALSI-2 and Neelam, were determined within the moisture content ranges of 7.47%, 10.78%, and 14.03%. It is located between figures 7 and 8.

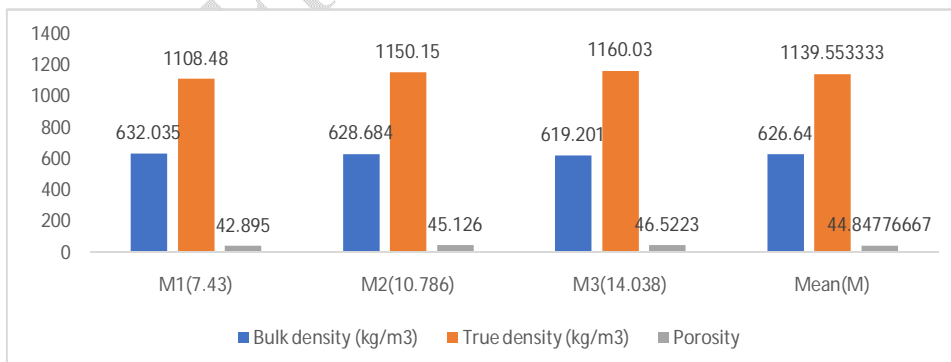

Fig.7 Moisture content's effect on bulk density, true density and porosity of linseed variety in SHUATS Alsi-2

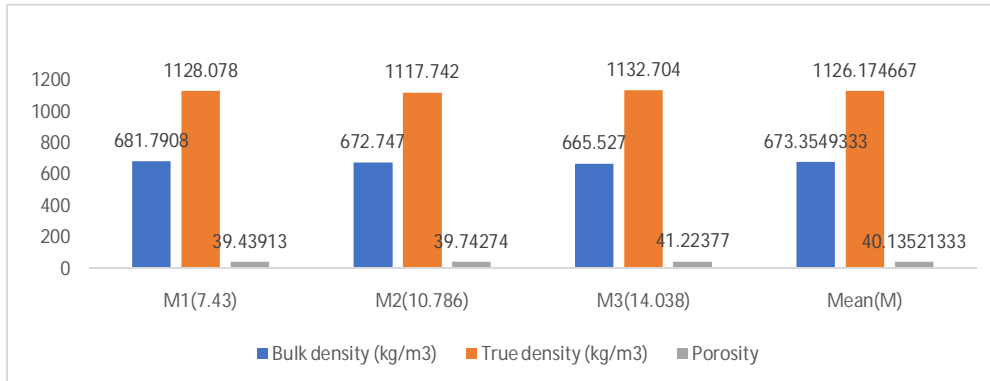

Fig.8 Moisture content's effect on bulk density, true density and porosity of linseed variety in Neelam

The SHUATS Alsi-2 variety had an average bulk density of 626.64 kg/m³, a true density of 1139.553 kg/m³, and a porosity of 44.847, whereas the Neelam variety had an average bulk density of 673.354 kg/m³, a true density of 1126.174 kg/m³, and a porosity of 40.135. The observed increase in linseed porosity with increasing moisture content is consistent with the findings reported by Coskuner and Karbaba (2007); Selvi et al. (2006); Bhishe et al. (2013); and Wang et al. 2007.

4. Conclusion

1. The physical properties of the linseed capsule were the mean value of the number of capsules per plant, the number of seeds per capsule, length, width, thickness of capsule, and GMD of 36.88, 8.12, 8.11mm, 6.94mm, 6.87mm, and 7.28mm.
2. Two varieties of SHUATS Alsi-2 and Neelam were discovered with moisture content ranging from 7.43% to 14.03%. Linseed seed linear dimensions (length, width, and thickness) were determined to be 5.308, 2.507, and 0.964mm for the SHUATS Alsi-2 variety and 5.214, 2.448, and 0.903mm for the Neelam variety. The mean GMD for the SHUATS Alsi-2 variety is 2.338mm, while the Neelam variety is 2.258mm.
3. The mean values of surface area, sphericity, volume, and TGW for the SHUATS Alsi-2 variety were 17.218mm², 0.441, 6.741mm³, and 7.656gram, respectively, whereas the Neelam variety was 16.04mm², 0.433, 6.047mm³, and 8.015gram.
4. The mean values of bulk density, true density, and porosity for the SHUATS Alsi-2 variety were 626.64 kg/m³, 1139.55 kg/m³, and 44.84, respectively, while the Neelam variety was 673.354 kg/m³, 1126.17 kg/m³, and 40.135.

Comment [h17]: , the

References

- Anazodo, U. G. N., Wall, G. L. and Norries, R., 1980, Corn physical and mechanical properties as related to combine cylinder performance. *Canadian Agril. Engg.*, 23(1): 23-30.
- AACC 2000. Approved methods, American Association of Cereal Chemists. 10th edition, moisture determination, 44-15A, Minnesota, St Paul.
- Akaaimo, D.I. and Raji, A.O. 2006. Some physical and engineering properties of prosopis africana seed. *Biosystem Engineering*, 95(2):197-205.
- Bulent Coskun, M., Yalcin Ibrahim and Cengiz Ozarlan, 2006, Physical properties of sweet corn seed (*Zea mays saccharata* Sturt.). *J. Food Engg.*, 74: 523–528.
- Bozon, B. and Temelli, F. 2008. Chemical composition and oxidative stability of flax, safflower and poppy seed and seed oils. *Bio Resource Technology*, 99(14):6354-6359.
- Bhise, S., Kour, A. and Manikantan, A.R. 2013. Engineering properties of flaxseed (LC 2063) at different moisture. *Journal of Post-Harvest Technology*, 01 (01): 52-59.
- Coskuner, Y. and Karababa, E. (2007). Some physical properties of flaxseed (*Linum usitatissimum* L.). *Journal of Food Engineering*, 78:1067–1073.
- El Fawal, Y. A., Tawfik, M. A. and El Shal, A. M., 2009, Study on physical and engineering properties for grains of some field crops. *Misr J. Agril. Engg.*, 26(4):1933- 1951.
- Gupta, R.K. and Das, S.K. 1997. Physical properties of Sunflower seeds. *Journal of Agricultural Engineering Research*, 66, 1-8.
- Mohsenin, N.N. 1986. *Physical Properties of Plant and Animal Materials*, 2nd Ed. Gordon and Breach Science Publishers, New York.
- Mwithiga, G. and Sifuna, M.M. 2006. Effect of moisture content on the physical properties of three varieties of sorghum seeds. *Journal of Food Engineering*, 75(4):480-486.
- Mahmoudi A., Tarighi, J. and Alavi, N., 2011, Some mechanical and physical properties of corn seed (Var. DCC 370). *African J. Agril. Res.*, 6(16): 3691-3699.
- Ovelade O. J., Odugbenro P. O., Abiove A. O. and Raji N. L. 2005. Some physical properties of African star apple (*Chrysophyllum albidum*) seeds, *Journal of Food Engineering*, 67:435-440.
- Patel, G., Naik, R.K. and Patel, K.K., Studies on Some Physical and Engineering Properties of Linseed. *Biological Forum- An International Journal*, 13(3):303-308.
- Singh K. K., Goswami T. K., 1996, Physical properties of cumin seed. *Journal of Agricultural Engineering Research*. 64: 93-98.
- Sacilink, K., Ozturk, R. and Kesikin, R. 2002. Some physical properties of hemp seeds. *Biosystem Engineering*. 86:191-198.
- Selvi, K.C., Pinar, Y. Yesiloglu, E. 2006. Some physical properties of linseed. *Biosystems Engineering*, 95 (4): 607–612.
- Singh, K., Mishra, H. and Saha, S. 2010. Moisture dependent properties of barnyard millet grain and kernel. *Journal of food engineering*, 96(4):598-606.
- Sharma, S. and Prasad, K., 2013. Comparative physical characteristics of linseed (*Linum usitatissimum*) Kernels. *Int. J Agri. Food Sci. Technol*, 4(7), pp.671-678.

Comment [h18]: Where in the paper?

Comment [h19]: The year different in paper why?

Comment [h20]: Where in the paper?

Comment [h21]: Where in the paper?
Find also year of published

Comment [h22]: Where in the paper?
It put after sevi not here

Comment [h23]: Where in the paper?

Singh, A.K., Sharma, V. and Yadav, K.C., 2014. Effect of moisture content on physical properties of flaxseed. *Research & Reviews: Journal of Food Science and Technology*, 3(2), pp.19-27.

Wang, B., Li, Dong, Wang, L., Huang, Z., Zhang, L., Chen X.D., and Mao, Z. 2007. Effect of moisture content on the physical properties of fibered flaxseed. *International Journal of Food Engineering*, 3(5):1-8.

Comment [h24]: Where in the paper?

UNDER PEER REVIEW